

XPENG X9
USER'S MANUAL



XPENG X9 is an ultra-intelligent MPV, with features distinct from conventional vehicles. Before beginning your X9 journey, please read this manual to understand the basic information about the vehicle, its fundamental operations, and relevant precautions and warnings. If you still have questions about using the vehicle, please contact the XPENG Service Center.

The User Manual corresponds to IVI version V5.4. On the CID, you can tap “☰→**General**” to view the current system version. If the system version is not up to date, please update it promptly.

Descriptions marked with “**” in this manual are only applicable to certain configurations. Your vehicle may not be equipped with these features.

The vehicle supports over-the-air (OTA) updates, and vehicle functions are regularly optimized/updated. The content of this manual will also be updated periodically.

This manual provides information on all configurations of the model. Due to differences in vehicle configurations, software versions, etc., there may be discrepancies with the vehicle purchased. Please refer to the actual vehicle.

Please read the warnings and cautions in the manual carefully:

▲ Warning Information: Must be complied with to avoid personal injury or traffic accidents!

▲ Caution Information: Must be complied with to avoid vehicle damage or malfunctions!



i Notes: These help you utilize the vehicle better.

The illustrations in this manual are for the purpose of explaining functionality and are for reference only.

Illustrations in the manual are annotated with:

➔ indicates the object described.

➞ indicates the direction of sliding operations.

↻ indicates the direction of rotation operations.

↕ indicates the direction of flipping operations.

No individual or organization is allowed to copy or modify the contents of this manual, in whole or in part, without authorization from XPENG. XPENG reserves the right to modify, supplement, or terminate the content of this manual and the technical specifications at any time.



Appearance

Introduction

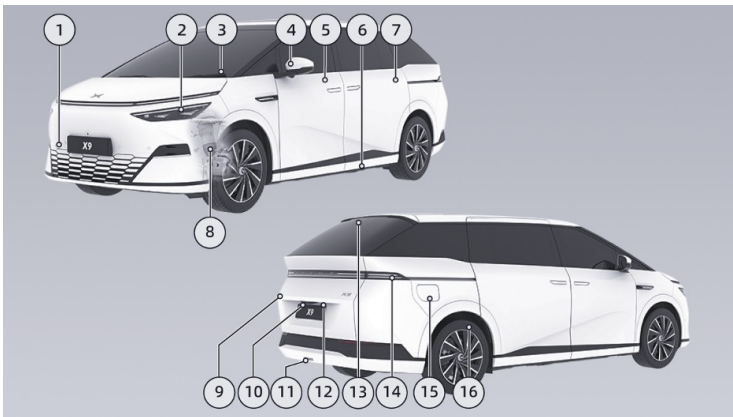

1. Towing hook cover
2. Headlight

- Light signal, clearance light, low beam, high beam, daytime running light, steering axillary light [See 264 page](#)
- Intelligent high beam [See 282 page](#)



3. Front wiper
 - Wiper operation [See 267 page](#)
 - Replacement of wiper blade [See 309 page](#)
4. Exterior rearview mirror
 - Angle adjustment, folding, and unfolding of mirrors [See 261 page](#)
 - Heating and defrosting [See 191 page](#)
 - Turn signal [See 264 page](#)
5. Electric door
 - Unlocking and locking [See 158 page](#)
 - Hidden electric door handle [See 172 page](#)
 - Open/close, opening angle, emergency open/close [See 173 page](#)
 - Umbrella holder (front passenger only) [See 221 page](#)
6. Courtesy light carpet [See 170 page](#)
7. Intelligent anti-pinch slide door
 - Unlocking and locking [See 158 page](#)
 - Hidden door handle, open/close, emergency open/close [See 175 page](#)
8. Air suspension [See 275 page](#)
9. Trunk
 - Open/close, opening angle, emergency open/close [See 180 page](#)
10. Streaming interior rearview mirror camera
11. Rear fog light, backup light
12. License plate light
13. High brake light
14. Taillight
 - Left turn signal, rear logo light, brake light and clearance light
15. Electric charging port cover [See 290 page](#)
16. Wheel
 - Tire maintenance [See 313 page](#)
 - Tire specifications [See 349 page](#)
 - Using snow chains [See 281 page](#)
 - Rear wheel steering [See 274 page](#)



Front-row

Introduction

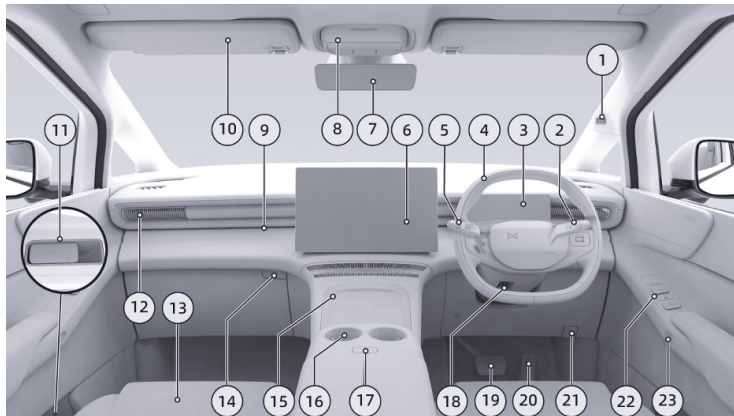

1. Interior camera
 - Driver status monitoring [See 121 page](#)
2. Gear shift lever [See 268 page](#)
3. Instrument cluster
 - Instrument interface, instrument indicator lights [See 27 page](#)
4. Steering wheel
 - Steering wheel buttons [See 234 page](#)



- Power steering [See 280 page](#)
- Horn [See 251 page](#)
- Driver's seat airbag [See 135 page](#)
- 5. Light & wiper lever
 - Lighting operation [See 264 page](#)
 - Wiper operation [See 267 page](#)
- 6. CID [See 19 page](#)
- 7. Streaming interior rearview mirror [See 286 page](#)
- 8. Front roof light
 - Reading light [See 209 page](#)
 - Hazard warning lights [See 324 page](#)
 - E-call *[See 342 page](#)
 - Emergency power off [See 184 page](#)
 - Glasses holder [See 221 page](#)
- 9. Ambient light [See 210 page](#)
- 10. Sun visor and vanity mirror [See 242 page](#)
- 11. Electric door emergency release handle [See 174 page](#)
- 12. Electric air outlet [See 198 page](#)
- 13. Front passenger's seat
 - Seat adjustment [See 251 page](#)
 - Seat heating [See 213 page](#)
 - Seat ventilation [See 216 page](#)
 - Seat massage [See 217 page](#)
- 14. Glove box switch [See 221 page](#)
- 15. Wireless phone charging [See 239 page](#)
- 16. Front row cup holder [See 221 page](#)
- 17. Center armrest box switch [See 221 page](#)
- 18. Steering wheel unlocking handle
 - Steering wheel position adjustment [See 285 page](#)
- 19. Brake pedal
 - Pedal feel adjustment, auto hold, comfort braking, electronic parking brake [See 270 page](#)
- 20. Accelerator pedal
 - Energy recovery [See 278 page](#)



21. Front hood release handle [See 302 page](#)

22. Door switch set

- Door lock switch [See 158 page](#)
- Window switch [See 201 page](#)

23. Front row electric door release button [See 173 page](#)

Second-row

Introduction

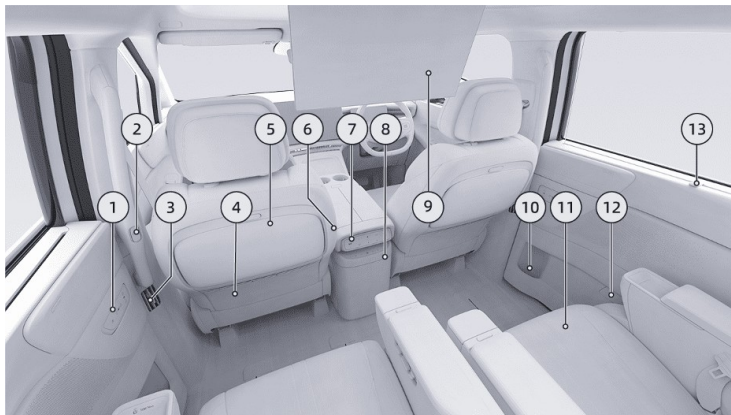



1. Slide door switch set
 - Window switch [See 201 page](#)
 - Rear row sunshade switch [See 206 page](#)
 - Second row infotainment screen switch [See 187 page](#)
2. Slide door [See 175 page](#)
3. Manual air outlet [See 198 page](#)
4. Front row seat magazine pocket [See 221 page](#)
5. Foldable tray [See 221 page](#)
6. Boss key [See 251 page](#)
7. A/C panel [See 191 page](#)
8. Electric open/close refrigerator with cooling and heating functions [See 211 page](#)
9. Infotainment screen [See 187 page](#)
10. Slide door cup holder [See 221 page](#)
11. Second-row seat
 - Seat adjustment [See 251 page](#)
 - Seat heating [See 213 page](#)
 - Seat ventilation [See 216 page](#)
 - Seat massage [See 217 page](#)
 - Zero gravity mode* [See 249 page](#)
 - Wireless phone charging* [See 239 page](#)
 - Type-C power port [See 244 page](#)
 - Phone panel*, cup holder [See 221 page](#)
12. Slide door emergency release handle [See 175 page](#)
13. Window sunshade [See 206 page](#)



Third-row

Introduction

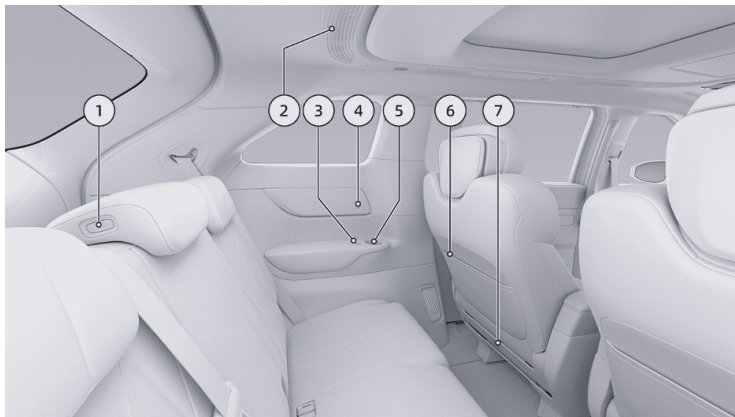

1. Middle headrest adjustment switch [See 252 page](#)
2. Surrounding air outlet
3. Side switch set
4. Type-C power port [See 244 page](#)
- Left/Right headrest adjustment switch, backrest angle adjustment switch [See 252 page](#)

Vehicle profile



5. Third row side panel cup holder [See 221 page](#)
6. Second row seat magazine pocket [See 221 page](#)
7. Child seat anchor points [See 145 page](#)



Trunk

Introduction

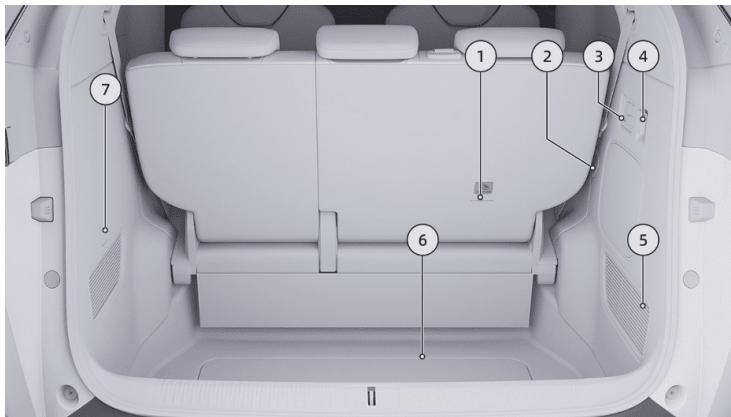

1. Child seat anchor points [See 145 page](#)
2. Emergency unlock cover of charging port [See 292 page](#)
3. Trunk combination switch
4. 12V power port [See 244 page](#)
5. Easy loading [See 275 page](#)
6. Seat backrest folding/storage switch [See 252 page](#)
7. Trunk combination switch

Vehicle profile



1

5. Trunk repair cover plate
 - Jump start [See 339 page](#)
6. Trunk cover plate
 - On-board toolkit, triangle warning sign [See 324 page](#)
7. Trunk light



Front trunk

Introduction

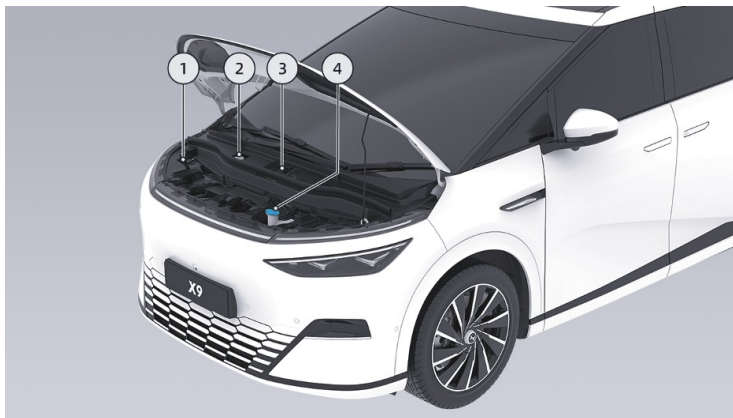

1. LV service switch
2. Brake fluid check and refill [See 305 page](#)
3. Coolant check and refill [See 303 page](#)
4. Fluid reservoir for windscreen washer fluid
 - Check and refill [See 308 page](#)
 - Refill amount [See 360 page](#)



warning

- There are a large number of HV components in the front trunk. Do not touch any position other than the windscreen washer fluid filler.
- Do not flush the front trunk directly with water to avoid danger.



HV components

Introduction

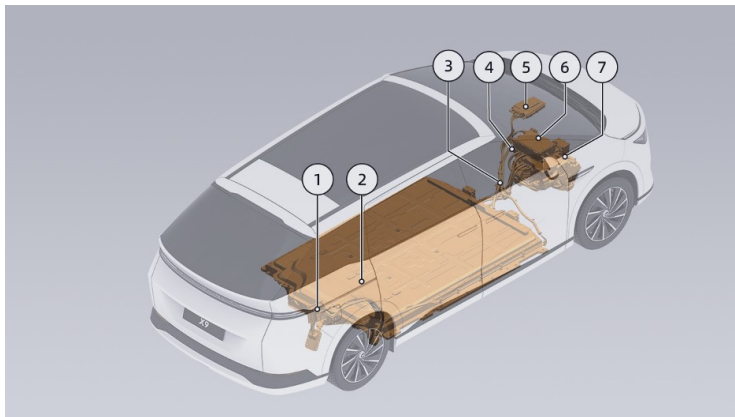

1. Charging port

- Charging operation [See 292 page](#)
- External discharge [See 236 page](#)

- Slow charge scheduled charging [See 299 page](#)
- #### 2. Traction battery



- Temperature control before fast charging
See 300 page
 - Low-temperature battery preheating See 284 page
 - Traction battery maintenance See 310 page
 - Traction battery recycling See 365 page
3. HV harness
 4. A/C compressor
 5. Heater
 6. Charger
 7. Front electric drive system
 - Types and parameters See 356 page



Intelligent driver assistance-hardware

Radar

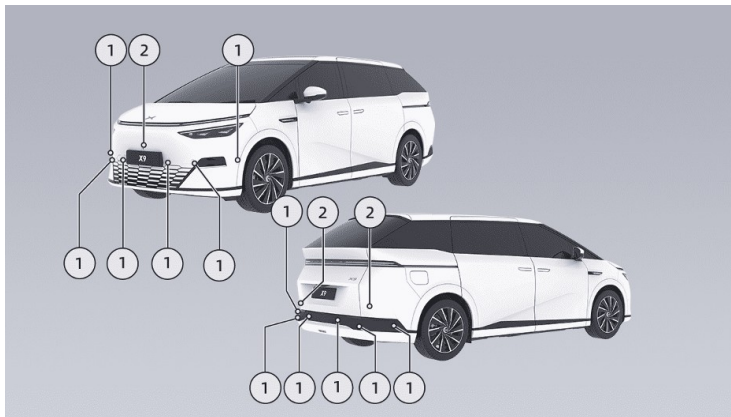

- 1. Ultrasonic radar
- 2. SRR



Camera

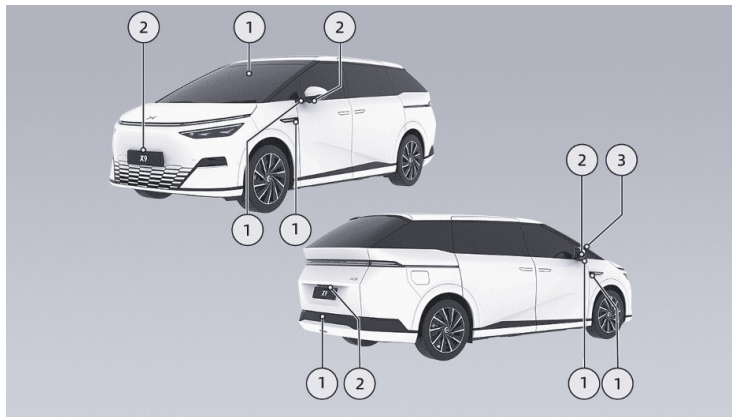

- 1. High-perception camera
- 2. Surround-view camera

- 3. Interior camera

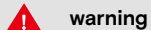

warning

If the functions of radar and camera are limited, driver assistance function cannot be enabled or realized normally.



CID interface

Introduction

The CID displays the split screens by default. The map navigation interface [See 41 page](#) is displayed on the left, and the all-domain intelligent driving interface [See 54 page](#) on the right.

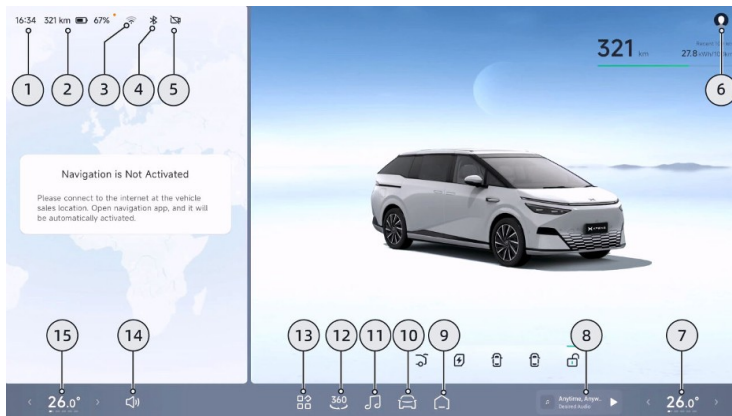



1. Time
2. Traction battery
 - It indicates the current driving range and SOC.
3. Network
4. Bluetooth
5. Driving recorder
 - Display the current status of traveling video recording.
6. Account & habit [See 37 page](#)
 - Tap Login to display the account avatar.
 - Set vehicle use habits.
7. Driver's seat A/C components
 - It indicates the current temperature and air volume of the driver's seat A/C.
 - Tap to adjust the A/C [See 191 page](#).
8. Music components [See 42 page](#)
 - It displays the currently playing media cover, media name and play source.
 - Tap to pause or resume music playing.
 - Swipe left or right to play the previous or next song.
9. Homepage
 - Tap to return to the homepage.
 - In the homepage, tap to switch between split screen and full screen.
10. Settings
 - Access to vehicle control setting.
11. Music [See 42 page](#)
12. AVM [See 61 page](#)
13. App Center
14. Volume adjustment
15. Front passenger's seat A/C components
 - It indicates the current temperature and air volume of the front passenger's seat A/C.
 - Tap to adjust the A/C [See 191 page](#).

i Tips

The font used for XOS is [MiSans].



Split-screen multitasking

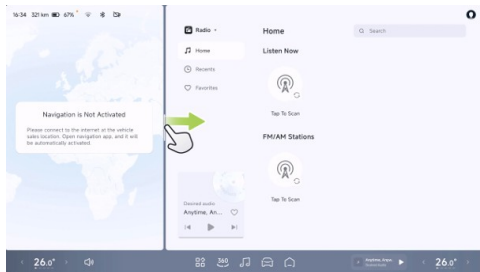

Drag the split screen line to switch between full screen/split screens, and change the window size for the split screen. When the split screen is switched to full screen, the last opened app with split screen will be memorized.

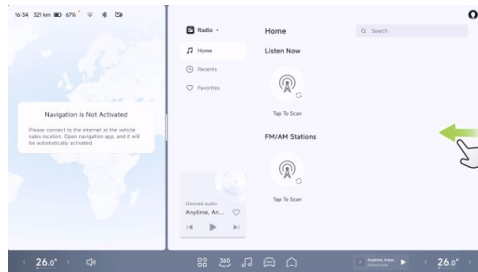

Slide to return to the previous page of the corresponding window.

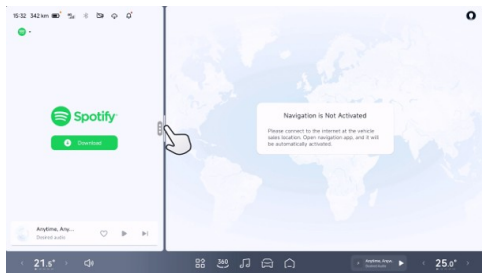

Tap the split screen line to fix the small window mode, in which the all-domain intelligent driving, maps, and music can be displayed.

2

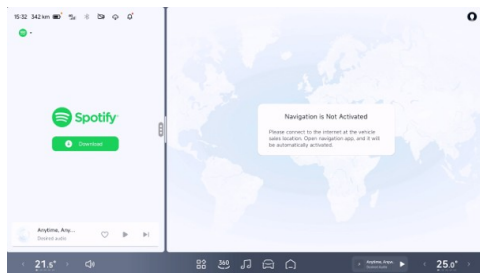

In the split screen mode, different apps can be opened in large windows, allowing, for example, the driver to view the navigation interface and the front passenger to watch videos, listen to music and read lyrics simultaneously.

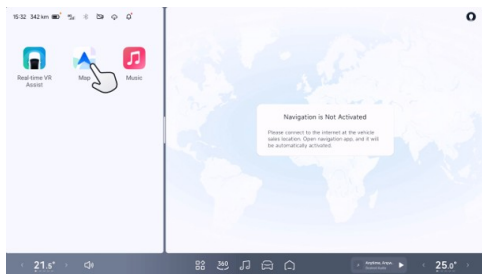



Gesture interaction

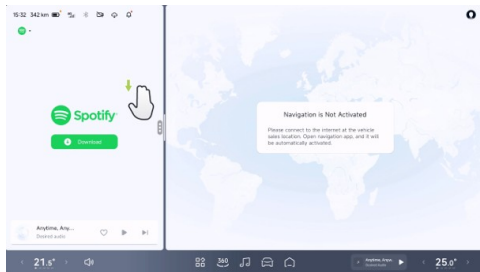

Three-finger swiping down allows exiting the app opened in the large window in the split screen mode and then returning to the corresponding homepage.

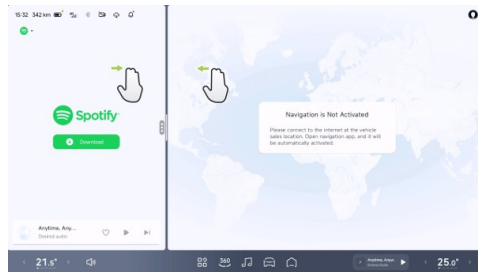

Three-/four-finger swiping left or right allows switch between different app windows. However, it doesn't work in full screen mode.

i Tips

This gesture is invalid for the bottom taskbar area. During the switch, the status bar and the bottom taskbar will not be hidden.

Customized bottom taskbar

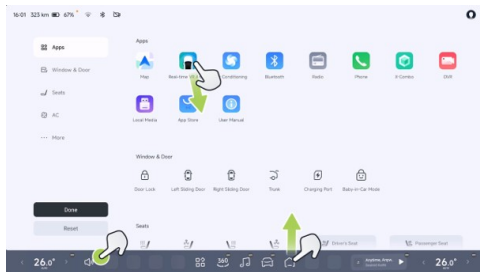

1. To customize the bottom taskbar, tap and hold the bottom taskbar icon or any area of the app list.
2. You can drag the function control and shortcut component icons in Apps, Doors & Windows, Seats, A/C and more to the blank at the bottom taskbar.
3. In the Custom status, tap in the upper right corner or drag the icon to the App

Center and release to remove the icon from the bottom taskbar.

4. To exit Customization, tap in the bottom taskbar space, in the app list blank or tap **“Done”**.
5. You can tap **“Reset”** to restore the bottom taskbar to its default state.

App Center

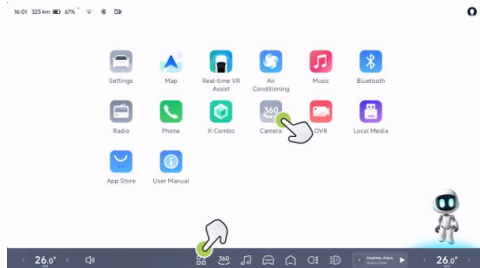

1. Tap in the bottom taskbar to open the App Center, and tap any blank space in the App Center to exit quickly.



2. Tap the app icon to open the app. Apps being downloaded and installed also have corresponding status display.
3. Tap and hold the app icon or blank space to enter the custom App Center status. At this time, you can drag the icon to sort in the app list.

Shortcut panel

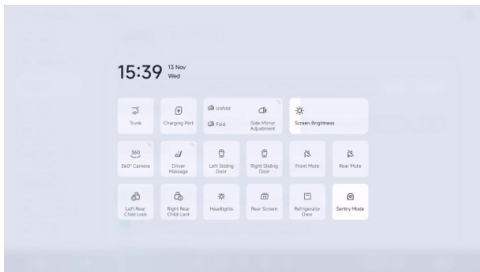

For high-frequency functions, you can operate directly from the shortcut panel without opening the app. Swipe down from the top of the screen

to unfold the shortcut panel, and swipe up to fold it. The shortcut panel is folded when you tap on a blank space or open a new screen.

Infotainment screen interface

Introduction

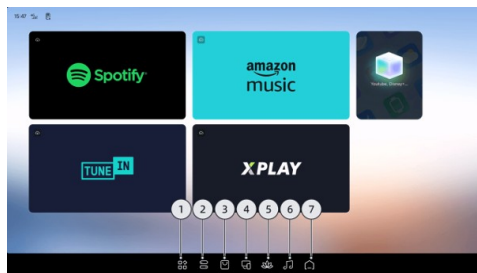

1. App Center
2. Shortcut panel
3. App Store
4. Screen Projection Assistant

5. Meditation Space
6. Music
7. Homepage



i Tips

The infotainment screen and CID share a third-party app, which does not support editing and sorting currently.

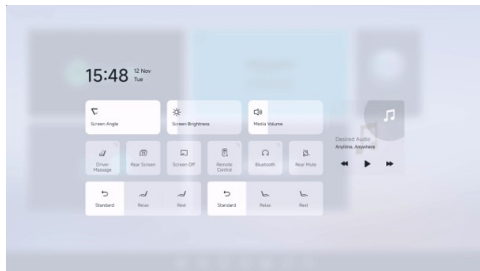
Shortcut panel



For high-frequency functions, you can operate directly from the shortcut panel without opening

the app. You can tap the infotainment screen , slide down from the top of the screen or use the remote control  to expand the shortcut panel of the infotainment screen. The shortcut panel is folded when you tap on a blank space or open a new screen.

App sharing

For apps with app-sharing capability, tap  to share videos or apps between the CID and infotainment screen.



Instrument cluster

Introduction

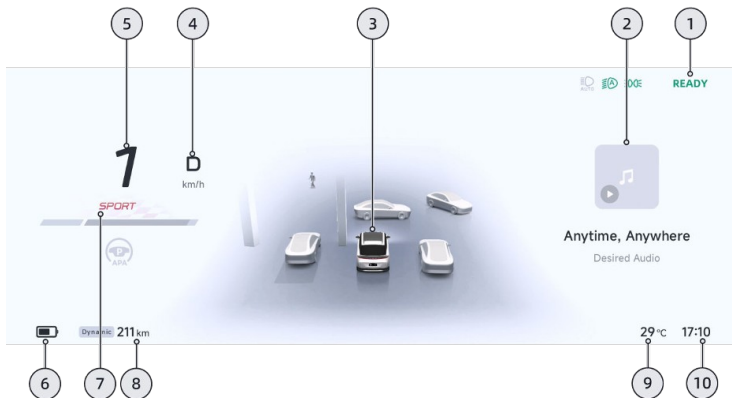

1. Indicator

- Indicators are distributed at different positions on the instrument to reflect the status of vehicle functions.

2. Right information display area

- Display information can be switched via steering wheel scroll button [See 234 page](#), allowing selection of vehicle condition,



energy consumption, mileage, navigation, music, etc.

10. Time

3. Intelligent driving mode [See 54 page](#)

- It displays the vehicle status.
- It displays the simulated vehicle external environment.

4. Gears [See 268 page](#)

5. Vehicle speed

6. SOC indicator

- On the “→**Charging and Discharging**→**Charging**” interface of the CID, you can turn on/off “**Battery Percentage Display**”.

7. Driving mode [See 273 page](#)

8. Driving range

- On the “→**Charging and Discharging**→**Charging**” interface of the CID, you can switch between WLTP/Dynamic.

9. Exterior ambient temperature



Instrument indicators

After the vehicle is powered on, some indicators will illuminate. After the system completes self-inspection, if the system is normal, these indicators will go out. Some indicators illuminate to display the current status of vehicle system functions, not a system fault. If there is anything unclear in the daily use of the vehicle, please consult the XPENG Service Center.



High beam on



SRS fault



Intelligent high beam on and the high beam on



The driver's seat belt is not fastened.



Intelligent high beam fault



The front passenger's seat belt is not fastened



Intelligent high beam on and the high beam not on



Second/third row left seat belts are not fastened



The left turn signal is on



The middle seat belt in third row is not fastened



The right turn signal is on



Second/third row right seat belts are not fastened



Low beam on



Speed limit on the speed limit sign



Rear fog light on



Air suspension soft and hard adjustment fault

READY

High-voltage system ready and the vehicle in a drivable status



Low washer fluid level indicator



Clearance light on



Partial function fault of air suspension



Auto-sensing headlight control is enabled and the low beam is on



Serious fault of air suspension



Charging cable connected



Battery fault



Timed charging ON



Coolant temperature too high



Steering system fault



Powertrain fault



Always on: parking function activated
Flashing: incorrect caliper status



Motor and controller overheating



Always on: parking brake fault
Flashing: parking system in repair mode



Motor and controller fault



AUTO HOLD activated



Traction battery temperature too low



AUTO HOLD fault



Traction battery temperature too high



Brake system fault



Traction battery SOC too low



Flashing: ESP activated
Always on: ESP fault



Traction battery fault



ESP OFF



Traction battery disconnected



ABS fault



FCW fault



Braking performance degradation



FCW OFF



HDC activated



Too many indicators are lit at the same time, and all the indicator display positions are occupied.



HDC fault



Driver assistance system fault



Tire pressure abnormal or tire pressure monitoring system fault



Rear wheel steering hardware fault



LSS fault



Rear wheel steering system fault



Driving power limit



Door opening Indicator



Maximum speed limit of ACC/LCC, and any function activated



LCC activated



Maximum speed limit of ACC/LCC, and both not activated



LCC can be activated



SAS activation



APA activated



APA unavailable



APA can be activated



LCC unavailable



ACC activated



ACC unavailable



ACC can be activated

Intelligent voice

Xpeng Voice Assistant

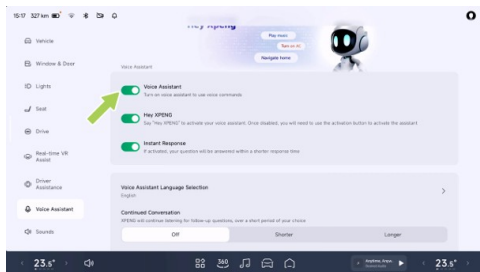

On the “**Voice Assistant**” interface of the CID, you can enable “**Voice Assistant**”. After that, functions such as “**Hey XPENG** and **Instant Response**” can be enabled.

i Tips

You can enable other intelligent voice functions only after “**Voice Assistant**” is turned on.

Wake-up mode

X-Peng can be woken up in the following ways:

- Steering wheel voice button [See 234 page](#)
- “**Hey XPENG**”

On the “**Voice Assistant**” interface of the CID, you can turn on/off “**Hey XPENG**”. After the function is enabled, add “**Hey XPENG**” before or after a command to initiate the X-peng service at any time. For example:

- Hey XPENG, turn on the A/C.
- Navigate home, Hey XPENG.
- How long will it take to reach the destination? Hey XPENG.
- Hey XPENG, play a song.

Voice Assistant Language Selection

From the CID “**Voice Assistant**→**Voice Assistant Language Selection**” screen, you can select language packs or download new language packs.



Dialogue mode

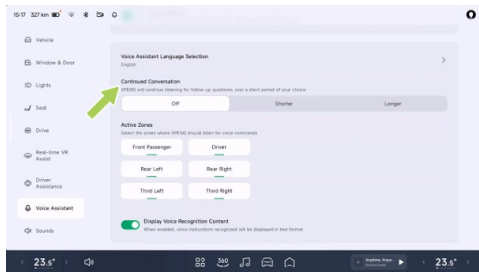

On the “**Voice Assistant**” interface of the CID, you can select "Off", "Shorter" or "Longer".

- Off: The dialog mode will be turned off after the option is selected.
- Shorter: After the option is selected, only one command can be executed by the X-peng for each dialog.
- Longer: After the option is selected, X-peng can keep listening for a period of time after executing the previous task. At this time,

X-peng can directly issue new commands without the need to repeatedly wake up it.

Multi-voice recognition zone

The intelligent voice supports the six voice recognition zones of the whole vehicle in three rows, and each passenger in the vehicle can wake up X-Peng at any time to have a dialog. Through the sound source positioning and voice separation capability of the six voice recognition zones, X-Peng can accurately distinguish which position gives commands and provides corresponding services. The dialog between passengers does not interfere with each other.

For example:

- When the driver says “**Open the window a little**”, X-Peng will open the driver’s window a little.
- A passenger on the right side of the second row says “**Hey XPENG, turn on the seat**

massage”, and then X-peng can turn on the second-row right seat massage function.

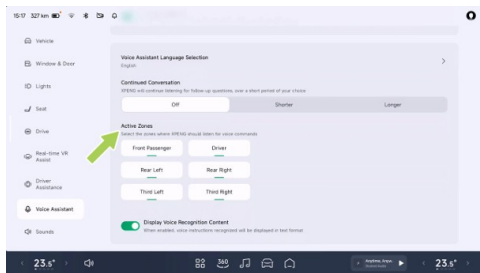

On the “**🚗→Voice Assistant**” interface of the CID, you can disable the voice recognition zone as necessary. After that, the system will no longer accept voice commands from this voice recognition zone.

Internet-free dialogue

In poor network environments such as underground garage, expressways and tunnels, some conversational services that rely heavily

on the Internet (such as playing music) are temporarily unavailable. However, X-peng can still provide you with basic voice services, including but not limited to the following functions:

- Voice control for A/C
- Voice control for seats
- Voice control for doors and windows
- Voice control for lighting
- Voice control for navigation

Join the User Experience Improvement Plan

In order to make X-peng smarter and smarter, we sincerely invite you to join the “**Intelligent Voice User Experience Improvement Program**”.

On the “**🚗→General→Safety and Privacy**” interface of the CID, you can turn on/off “**Join User Experience Improvement Plan for Voice Assistant**”.

Before enabling this function, you need to review and agree with the Intelligent Voice



User Experience Improvement Program. After this function is enabled, the system can collect voice usage information to improve your voice interaction experience.

User account

Introduction

You can log in, log out and switch accounts by tapping the avatar in the upper right corner of the CID.

Operation

Login account

Tap the default gray avatar (not logged in) in the upper right corner of the CID, and scan the QR code with your mobile App to log in. After successful login, all account memory settings of the account will be automatically synchronized to the current vehicle.

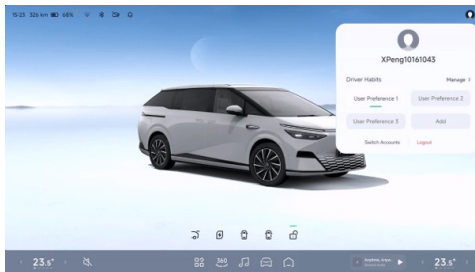

Tap the avatar, and an account floating window will be displayed to select the habits you want to use. The habits of every user, including driver's seat position and rearview mirror position will be memorized. You can also tap **"Add"** to create a new habit. Up to 6 habits can be created.

Tap **"Manage"** and long press the habit you want to edit to change the name of the habit or delete it.



Switch account

In the account floating window, tap “**Switch Accounts**” to switch accounts by scanning the QR code with your mobile APP.

Log out

In the account floating window, tap “**Logout**” to log out of the current account.

i Tips

After logging out the account, you can still use most functions of the vehicle, but the memorized habits will not be available. If you want to use functions such as the driver assistance system, you need to log in with your account.

System update

Introduction

The vehicle supports remote updates through CID or the mobile APP to provide your vehicle with the latest functions. It is recommended that

you install a new version of the system as soon as possible after receiving the system update prompt “🔄”.

i Tips

- Make sure that the vehicle is connected to the Internet. The update push will not be received until the vehicle is connected to the network.
- If you have any other questions, please contact the XPENG Service Center or Customer Service Center.



System version

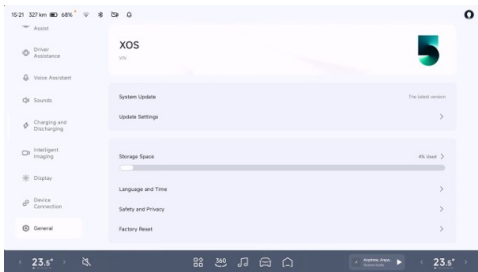

On the “**General**” interface of the CID, tap the “**XOS version number**” on the top to view the details of the current IVI version.

Update settings

Tap “**Update Settings**” to set the “**Auto Update**” function. When the vehicle detects a new update later, it will automatically update at 3:00 am without manual confirmation.

i Tips

It is recommended to enable the “**Auto Update**” function to keep the vehicle system up-to-date at all times.

Update method

When a new version is available, the system will push a notification to remind you that there are new versions for update. The “**new version**” icon will be displayed in the “**System update**” column, and the system update icon  will appear in the status bar on the top of CID.

To view the update description of a new version, tap the update icon  on the CID status bar or tap the “**System update**” bar.

When there is a new version for update, the system can be updated in the following three ways:

Update Now

On the update instruction page of new version, tap “**Update Now**”. The system will prompt you



that **“The vehicle cannot be used during the update process”**, so make sure that the vehicle is parked in a safe area and reserve enough time.

Tap **“Confirm”** to immediately enter the update preparation stage. At this stage, update conditions will be checked, and the process cannot be suspended after confirmation.

Reserve Update

On the update instruction page of the new version, tap **“Reserve Update”** to set the time period when you do not need to use the vehicle. Tap **“Confirm”**, and the system will be updated when the vehicle is locked during the set period.

After the reservation is updated, the system update page will display the reservation information. Before the update starts, you can tap **“Cancel reservation”** at any time and reserve another system update time.

Remote update through mobile app

The vehicle supports remote system updates with **“XPeng App”**. When there is a new version

to update, the APP will send a message notification, and the vehicle control interface will display the card of the new version, or the icon of the **“New Version”** will be displayed on the upper left corner of the vehicle control. Tap the card button or the **“New Version”** icon to enter the remote system update interface, and tap **“Update Now”** to complete the update.

Cautions and limitations

- Before updating, make sure that the remaining power of the vehicle is greater than 10%, the gearshift lever is in P position and parked in a safe area.
- After entering the update, it cannot be stopped and the vehicle cannot be used during the update. Please leave enough time to wait for the update to complete.
- The vehicle cannot be charged during the update process. Arrange the time for updating and charging reasonably.
- System update failure may cause some functions to be abnormal. If the update fails,



do not use the vehicle. Tap **“Retry”** to start the update again. If retrying for several times fails, please contact the XPENG Service Center or Customer Service Center.

- Once updated, the system cannot be reverted to previous versions.

Navigation

Seamless navigation

Introduction

Seamless navigation can be achieved by sending an address to the vehicle from your mobile phone and promptly starting navigation after logging in and binding the mobile App.

Operation

Taking Penning APP as an example, seamless navigation can be realized through the following operations:

1. Tap the **“Penning→Search box”** on the mobile App interface in turn to set the navigation destination.
2. Tap **“Send to Vehicle”** to send the destination information to the CID of the vehicle.
3. After the CID receives the navigation information sent by the mobile phone, a confirmation card will pop up. Tap **“OK”** to realize seamless navigation.

Charging planning

For long-distance travel, the system can automatically plan driving and charging routes according to charging preference.

1. On the map interface of the CID, tap **“Map Settings”** to adjust the minimum SOC separately for arrival at the charging station and the destination in the **“Charging Route Preference”** settings.

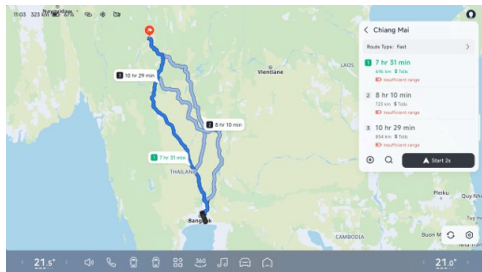

2. Tap **“Charging”** on the route planning interface to enter the intelligent charging planning interface. The system will automatically plan charging stations along the way, and display information such as charging station information, driving interval distance, recharging times and time length. Tap **“Start Navigation”** to start the journey.

i Tips

If the current SOC is sufficient to reach the destination, charging stations will not be added automatically.

3. During driving, the distance to charging station and estimated arrival time will be updated dynamically.

2

Music app

Introduction

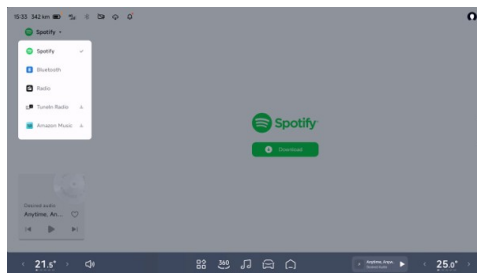

XPENG provides customized music apps, supporting audio sources such as Spotify, Radio and Bluetooth.



Tap “🎵” in the bottom taskbar of the CID, and switch and play the audio source at the audio source entrance in the upper left corner of the music interface.

Radio

The vehicle supports local radio FM.

Switch the audio source to “**Radio**” to play local radio stations.

Bluetooth

Switch the audio source to “**Bluetooth**”, tap “**Connect Bluetooth**” to connect the mobile phone Bluetooth, and then you can listen to songs from the mobile phone in the vehicle.



AI Intelligent Driving

Adaptive Cruise Control (ACC)

Upgrade

Optimize key scenarios to reduce the frequency of false deceleration problems.

Lane Centering Assist (LCC)

Upgrade

High-speed control optimization.

Optimize the problem of slight left and right swing of LCC at speeds above 130kph to ensure smooth driving on high-speed roads.

New Features

1. Added intelligent calibration mechanism (self-calibration).
2. The system will automatically calibrate the camera while driving to optimize lane centering accuracy and improve driving stability and safety margins.

3. 30 days after each self-calibration is completed, the next self-calibration will be automatically triggered.

4. Each calibration process generally requires driving for tens of kilometers to complete, and the specific distance depends on the driving conditions and environment.

For example, calibration can be completed faster when the vehicle is traveling on a straight road with multiple lanes and clear lane markings for both the driving lane and adjacent lanes.

i Tips

It may take up to one month for the first calibration after the update to be completed and effective.

AI Bodyguard

Driving Recorder

Upgrade



Driving recorder adds tracking and reversing status record*(If applicable)



AI Cockpit

Battery percentage display

Upgrater

The estimated range at the destination has been increased to include battery percentage display, making battery management more intuitive.

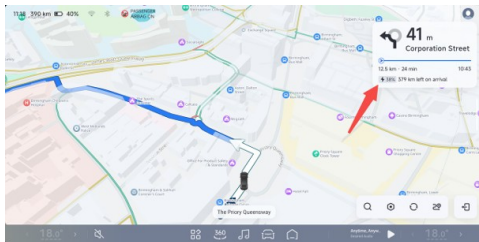

3

Navigation voice broadcast

New Features

Support Hebrew navigation voice broadcast.

Navigation optimization

Offline map

1. Added recommended download areas to the offline map management page.
2. Download offline map data for the current area and navigate even without a network connection.

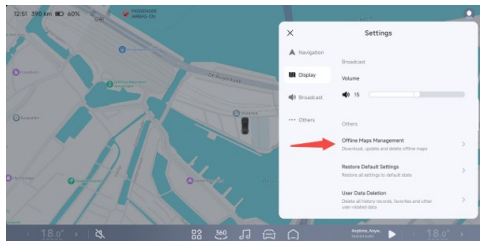

New Features

1. Navigation performance continues to improve, map operation and animation effects are smoother.
2. Navigation search association capability upgraded, recommended results are more accurate after entering.
3. Optimize the guidance strategy and map view of the large screen and instrument navigation, and make the route guidance clearer.

4. More function buttons are always present in the navigation for more convenient search and other operations, see:

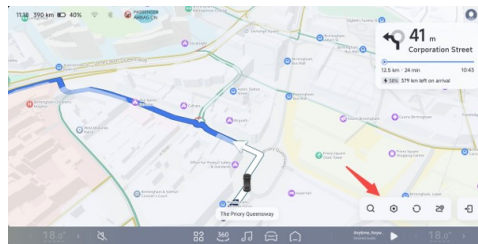

Visual Improvement

1. The map style is dynamically adjusted according to browsing, navigation, and other scenes, providing a more suitable user experience.
2. Newly upgraded map style, clearer road network hierarchy, and richer location elements :

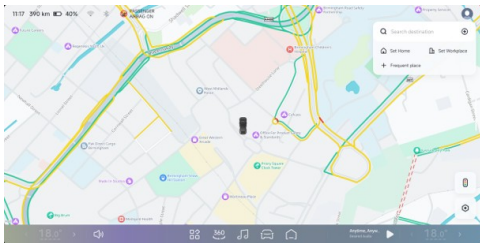

3. Switching between day and night modes with smooth transitions for a more natural visual experience.

Guest Mode

Introduction

New Features

Visitor mode, replacing the original logged in state, automatically opens when unlocking the vehicle with a remote key.

Operation

1. If the user's vehicle is in an unregistered state before OTA, after OTA, the vehicle status changes to guest mode, and the vehicle settings can be stored content remain unchanged;

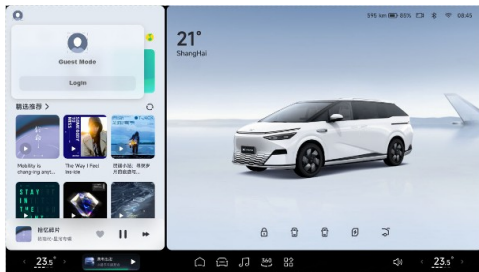

X-Combo

User combo experience upgrade

New Features

OTA Update 5.6.0



1. Enhanced perception capabilities, including Sentry mode triggering, temperature sensing inside and outside the vehicle, speed sensing, and remaining range sensing.
2. Expansion of execution actions, including the addition of Sentry mode switch, driver status monitoring reminder switch, emergency lane keeping sound warning switch, intelligent speed limit auxiliary alarm sound switch, and the ability to execute based on judgment conditions.

Share Inheritance Function

Introduction

Add scene code to the scene. The car application can view scene codes for various scenarios, and scene codes shared by others can be found and added by entering them in the search portal. Support cross vehicle scenario sharing.

Operation-Combo code

1. Click  , find X-combo, and you can see a combo code on the top right corner.

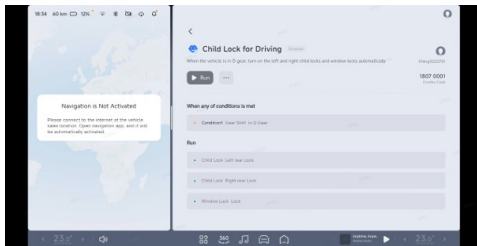

2. You can also enter Combo name or Combo code from the Search Bar.

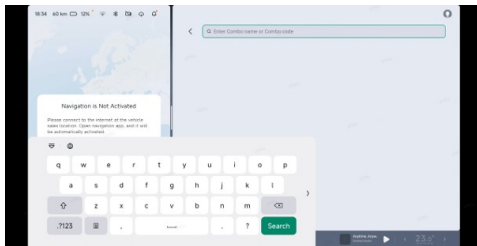

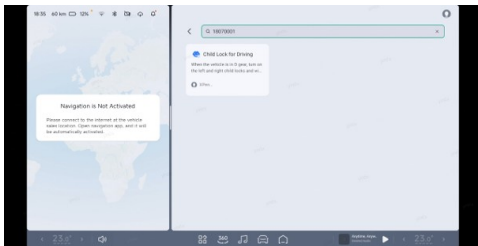

Operation-Mobile APP

The mobile APP adds a new sharing inheritance function. The scene can generate a QR code or link to share. Others can scan or click the code to view the detail and add:

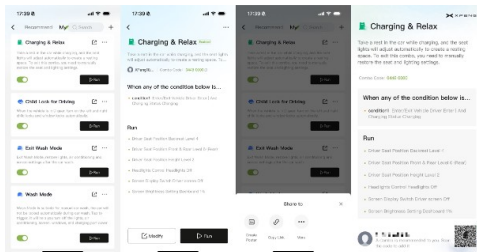

3

Recovery function

Introduction

New Features

A new recovery function has been added to the car computer. During and after the scene is running, the front air conditioning, seat position, and screen display can be restored to the state when the scene was triggered.



Bluetooth Call

Introduction

New Features

When making a Bluetooth call, you can quickly hang up the call by scrolling on the right side of the steering wheel.

The sound quality of Bluetooth calls is improved; the sound quality of CarPlay calls is improved, reducing intermittent and stuck calls, and reducing voice distortion.

Mobile-Vehicle interaction

Introduction

Air conditioning reservation supports custom cycles, and any combination of reservations can be set from Monday to Sunday.

Operation

Operation

1. Open the mobile APP, and click A/C Schedule.
2. Open Air Conditioner Timing and then set custom cycle
3. Add a new booking according to your needs:

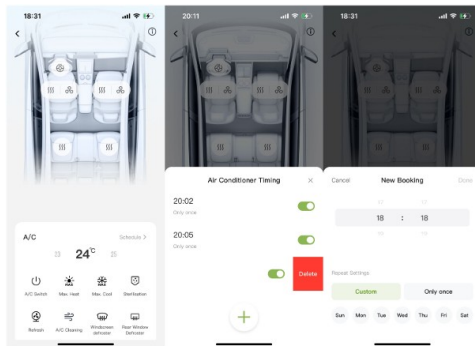



Account memory

Introduction

New Features

Vehicle control – sound and display settings can remember the switch status according to the Xpeng account and better understand your car usage habits.

Charging

Charging Network*(If applicable)

New Features

Currently, there are more than 850k charging piles (supporting start/stop), covering more than 85% of the European charging network. Xpeng continues to be committed to expanding the charging network and improving the experience, so that your travel is no longer constrained by the power supply, and you can enjoy the convenience of charging anytime, anywhere.

i Tips

CID Coverage Countries

Currently supports 18 European countries: France, Germany, United Kingdom, Denmark, Netherlands, Italy, Belgium, Austria, Czech Republic, Croatia, Hungary, Ireland, Luxembourg, Poland, Slovakia, Slovenia, Switzerland, Latvia (countries will continue to expand in subsequent versions)

i Tips

Mobile APP Coverage Countries

Currently covers 24 European countries: France, Germany, United Kingdom, Norway, Spain, Sweden, Estonia, Lithuania, Finland, Denmark, Netherlands, Italy, Belgium, Austria, Czech Republic, Croatia, Hungary, Ireland, Luxembourg, Poland, Slovakia, Slovenia, Switzerland, Latvia (countries will continue to expand in subsequent versions)



Charging Station Information

Introduction

1. Charging map: New charging station map control. Once turned on, the surrounding charging station information can be displayed on the map first, making planning more convenient.
2. Flexible filtering: Added multi-dimensional charging station filtering, supporting conditions such as power, brand, interface type, etc., to improve the efficiency of charging station search.
3. Voice search: Supports searching for nearby charging stations through voice assistant, making the search for charging stations more convenient.
4. Real-time information: The station adds charging prices, station numbers and other detailed information to help you find your favorite charging station.

Optimization

Route planning: The algorithm for adding charging stations for long-distance intelligent routes has been upgraded, and the charging station planning results are better. (The Mobile App will be updated in subsequent versions)

Charging Start

New Features

1. Start with charging card: Take out the charging card and swipe it to quickly start the charging process. Say goodbye to tedious operations and enjoy the ultra-fast charging experience easily.
2. App launch: Supports charging initiated through the Xpeng mobile App. Just a touch of your fingertips and your car will instantly enter charging mode.

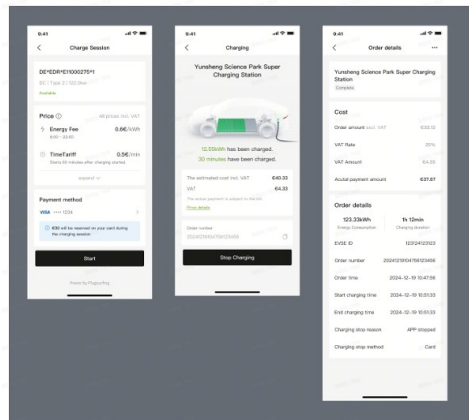



Environment simulation display SR

Instructions for SR

The SR can simulate and display the current day/night effect and traffic environment around the vehicle on the instrument and CID.

SR interface of instrument cluster



SR interface of CID



The SR interface includes the following functions:

- 3D Vehicle Control [See 55 page](#)
- 3D charging [See 56 page](#)
- Driving risk warning [See 59 page](#)
- Preceding vehicle start reminder [See 60 page](#)

warning

SR is only a driver assistance function. As the driver of the vehicle, you are responsible for



driving safety. Do not rely on this function to control the vehicle; otherwise, injury or even death may be caused.

Warnings, cautions and limitations

warning

SR cannot work normally in the following scenarios:

- Camera limited .
- The vehicle is running on a road with large curves or poor road conditions.

warning

The following situations are possible for SR:

- Falsely displaying a type of object as an analogue of another type.
- To simulate and display an object in the wrong direction or distance.

The above warnings, cautions and limitations do not cover all conditions that may affect the normal operation of SR.

All-domain intelligent driving

3D CID

Instructions for 3D Vehicle Control

When the vehicle is in the P position, tap the icon below the CID 3D model or directly tap the hotspot on the model to unlock/lock the vehicle (only the icon is supported) or open/close the Slide door, charging port, and trunk.



Tips

On the “Window & Door” interface of the CID, you can turn on/off “**P Gear Shortcut**”.



After shifting to P gear, common control options will be displayed in the lower right corner of the CID, and one-touch operation is more convenient.

3D charging/discharging

Instructions for 3D Charging/Discharging

When the vehicle is in the P position, after inserting the charging plug or external power supply equipment, CID will automatically display the charging/discharging SR and visually observe the charging/discharging progress.

i Tips

- Please refer to the charging instructions for specific vehicle charging operations.
- For the specific operation of the external discharge of the vehicle, please refer to the external V2L discharge .

Preset charging

This interface displays information such as preset charging start time and current driving range.

- Tap “**Charging limit**” under the car model to navigate to the “**Charge/Discharge**” interface. You can customize “**Charging limit**” See 298 page. You can also select “**One-tap Optimum**”, and the system will set the optimal charging limit according to the current traction battery state.

i Tips

It is recommended to use the optimal charging limit recommended by the system, and the charging speed will be faster.

- Tap “**Current**”, “**Voltage**”, and “**Power**” to pop up a charging curve window.
- Tap “**Start charging**” to get ready for charging.



All-domain intelligent driving

Ready for charging

During charging preparation, the system will heat the traction battery and automatically enter charging after reaching the specified state.

Charging

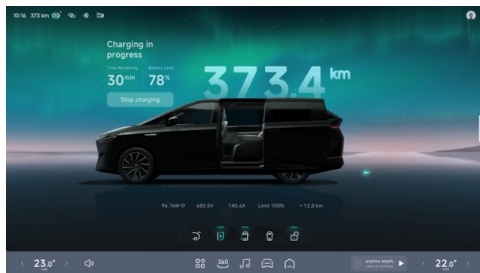

During charging, this interface displays the current driving range, estimated remaining time, increased driving range, additional driving range compared with ordinary fast charging, charging limit, current, voltage, power and other charging

information. Tap **“Stop charging”** to finish the charging.

Charging fault

If a fault occurs during charging, the charging interface will pop up the cause of the charging fault and operation suggestions.

warning

If there is a fault prompt, do not try to charge again, and contact the XPENG Service Center immediately.

Charging completed

After charging is completed, the interface displays charging information such as current driving range, charging duration and new driving range.

External discharge in preparation

After an electrical device is plugged in, it will be displayed on the interface that the electrical device is connected.



- Tap “**Power supply limit**” at the bottom of the vehicle model to jump to the “**Charging and Discharging**” Interface. You can customize “**Power supply limit**”.

i Tips

The minimum limit for external discharge of the vehicle is 20% SOC of the traction battery.

- Tap “**Current**”, “**Voltage**”, and “**Power**” to pop up a discharging curve window.
- Tap “**Start supply**” for immediate external power supply.

External discharge in progress

The interface displays charging information such as current driving range, discharged electricity, reduced driving range, power supply limit, current, voltage and power.

Tap “**Stop supply**” to complete the discharge.

External discharge fault

If a fault occurs during external discharge, the fault cause and operation suggestions will pop up on the interface.

⚠ warning

If a fault prompt appears, do not retry external discharge. Please contact the XPENG Service Center immediately.

External discharge stopped

- When the power supply limit is reached, the system stops the external discharge. If you want to continue to supply power at this time, you need to reset the power supply limit and tap “**Start supply**”.
- If you want to continue to supply power after tapping “**Stop supply**”, you can directly tap “**Start supply**”.



All-domain intelligent driving

i Tips

If the power supply limit reaches 20% SOC of the traction battery, external discharge cannot continue.

Driving risk warning

Instructions for Driving Risk Warning



When the driver assistance system is not turned on and the vehicle is in D gear, if the surrounding dynamic obstacles are close to the vehicle or

there are potential safety risks, the SR interface will give a warning.

The medium-risk obstacle warning will turn red, and the high-risk one will also turn red with a sound prompt.

Warnings, cautions and limitations

The driving risk warning is only used for warning, and the driver has the responsibility to observe the surrounding environment and make decisions accordingly.

warning

The driving risk warning may not be triggered in the following cases. Including but not limited to:

- Radar or camera limited .
- The vehicle is running on a road with large curves.
- When the vehicle is running on a road with poor conditions.

All-domain intelligent driving



The above warnings, cautions and limitations do not cover all situations that affect the normal operation of driving risk warning.

Preceding vehicle start reminder

Instructions for Preceding Vehicle Start Reminder

When the driver assistance system is not turned on and the vehicle is in D gear, if it is on a congested road section, after the vehicle ahead has traveled for a certain distance, the SR interface will display the animated effect to remind the driver to start.

Warnings, cautions and limitations

The driving risk warning is only used for warning, and the driver has the responsibility to observe the surrounding environment and make decisions accordingly.

warning

The driving risk warning may not be triggered in the following cases. Including but not limited to:

- Radar or camera limited .
- The vehicle is running on a road with large curves.
- When the vehicle is running on a road with poor conditions.

The above warnings, cautions and limitations do not cover all situations that affect the normal operation of driving risk warning.



360 AVM

Instructions for AVM

The AVM system captures the surrounding environment of the vehicle through the surround-view cameras around the vehicle and displays the environment on the CID.

The surround view cameras are installed above the license plate and below the left and right exterior rearview mirrors respectively [See 18 page](#).

The AVM can be accessed through the following ways:

- X-Peng voice
- “360” in the bottom taskbar of the CID

caution

Objects in the AVM screen and real objects will be deformed to some extent.

warning

AVM is only a driver assistance function and cannot cope with all traffic, weather and road conditions. As the driver of the vehicle, you are responsible for driving safety. Do not rely on this function to control the vehicle; otherwise, injury or even death may be caused.

2D mode image

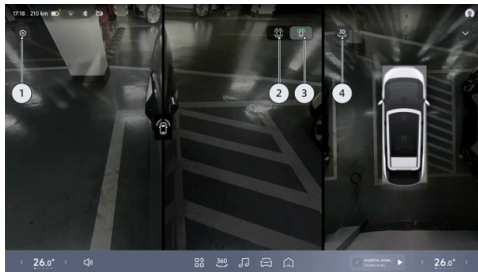

1. Image setting



Tap “” to jump to the “Intelligent Imaging” interface, where you can set image-related functions.

2. Hub view icon.
3. Front hub view icon.
4. 3D/2D mode switching.

Image of shifting to D gear

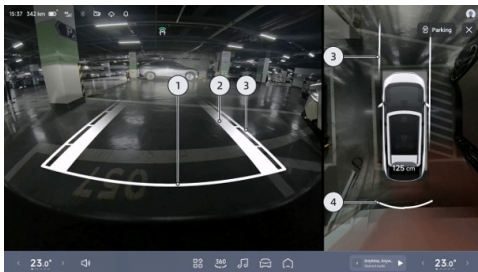

1. Safety stop line
 - It indicates the position about 0.3 m behind the vehicle.

warning

When the safety stop line contacts an obstacle, please stop reversing.

2. Tire track surface
 - It indicates the driving route of wheels.
3. Dynamic auxiliary line
 - The width of the vehicle is indicated by two thin white lines.
 - In the front/rear view, segmented scale lines are used to indicate the distance between vehicles and objects.
 - The distances indicated by each scale line from near to far are about 0.6m, 1m and 1.5m respectively.
4. Radar warning
 - It simulates display according to the distance and direction of obstacles.
 - When white is displayed, the distance is long.





- When red is displayed, the distance is very close.
- The distance between the vehicle and the nearest obstacle will also be displayed as a numerical value in front of and behind the vehicle respectively.

3D mode image



- After the system is switched to the 3D mode, it will integrate the 3D virtual model into the real environment image.

- You can swipe  around the right model ring or directly swipe the left model to achieve free 360° rotation.
- If there is no operation on the screen within 5 seconds, the circle and icon will be automatically hidden. Tap the top view area to display the circle and icon again.
- Tap “” on the current interface to enable “**3D Transparent Body**”. The 3D virtual model will be switched to the transparent status for direct observation of road conditions under the chassis.
- Tap “” on the current interface to enable “**Transparent Chassis**”. When the vehicle is running at a low speed, the right top view will be switched to transparent chassis, and the virtual model will be superimposed on the image of real road surface for easier observation of crash risk around the body.



caution

Objects in the display may be deformed compared to actual objects.

warning

Transparent chassis and 3D transparent car body are only used to assist in observing the vehicle bottom during parking and driving. Do not rely on this function completely.

Reversing image hold of shifting to R gear

On the “ →**Driver Assistance**→**Parking**” interface of the CID, you can turn on/off “**Reversing Image Hold**”.

When the function is activated and the gear is shifted from R to D, the AVM will be switched to the front view. When the gear is shifted to P or the vehicle speed exceeds 10 km/h, the AVM will exit automatically.

Automatic off of AVM

On the “ →**Driver Assistance**→**Parking**” interface of the CID, you can turn on/off “**360 Camera Auto Turn Off**”.

When the AVM is manually turned on, if the speed exceeds 30 km/h and there is no operation for 5s, the AVM will be automatically turned off.



Activate AVM on narrow roads

Instructions for Activate Panoramic Image on Narrow Roads

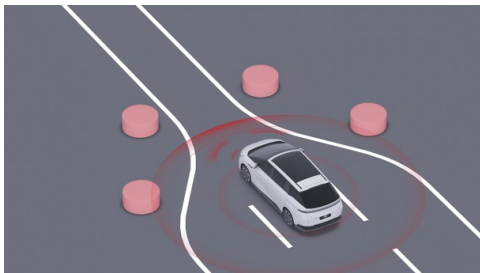

When the vehicle is in the D position and the speed is less than 15 km/h, if obstacles are detected on both sides of the front and rear of the vehicle, the vehicle will open the Activate Panoramic Image on Narrow Roads for driving assistance.

Opening and closing

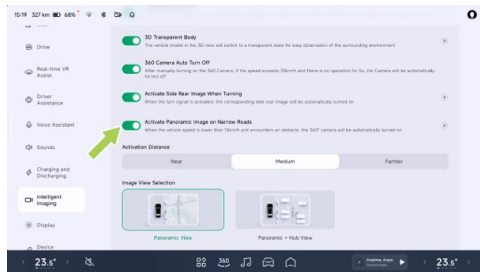

On the “ Intelligent imaging” interface of the CID, you can turn on/off “**Activate Panoramic Image on Narrow Roads**” and select different sensitivity levels according to your driving habits.

Tips

- Trigger range: close about 50 cm, medium about 60 cm and far about 75 cm.
- If the All-domain Intelligent Driving has been enabled when conditions are met, the

Intelligent image



system will automatically pop up a top view window in the interface.

Steering activation side rear image

Instructions for Activate Side Rear Image When Turning

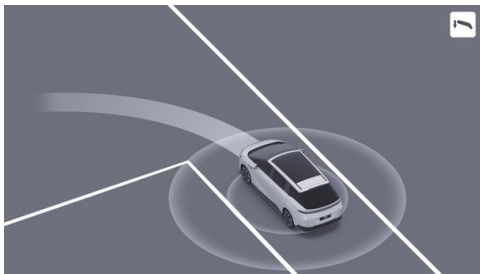

When the vehicle is in the D position and the turn signal is turned on, the rear image of the corresponding side will be automatically turned on for the driver to view the rear blind spot on the side and assist in driving.

Opening and closing

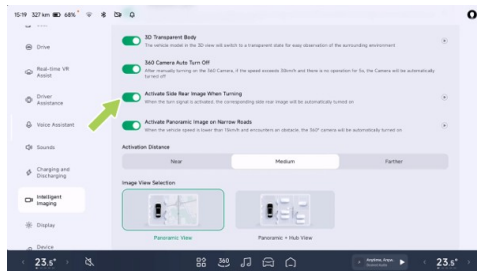

5

On the “ Intelligent imaging” interface of the CID, you can turn on/off “**Activate Side Rear Image When Turning**”.

i Tips

If the All-domain Intelligent Driving has been enabled when conditions are met, the system will automatically pop up a top view window in the interface.



Interface display

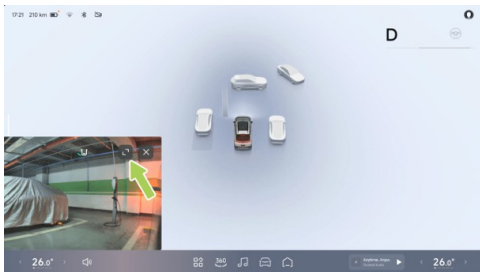

You can drag an image to different positions, and tap **L** on the image interface to zoom it in/out.

Driving recorder

Instructions for driving video recording

The driving video recording feature enables video recording during vehicle operation, and store the videos on a USB drive. The video

files can be used to review past information or assist with evidence collection in the event of an accident.

i Tips

The USB media source port and Type-C power port located at the front of the console support data transmission function. Once a USB drive is inserted, the driving video recording feature can be used.

Recording information

While recording driving videos, it will also synchronously record the vehicle driving status and driving information but without audio from inside or outside the vehicle.

Recording view

Driving video recording offers the option to record either **“Main view”** or **“Main view + surround view”** for driving recording.

- **“Surround view”** records the corresponding surround images at the given time. If features



such as the AVM or reversing image function are in use during recording, “**Surround view**” will capture the corresponding perspective.

- “**Main view + surround view**” mode records the front view and the surroundings simultaneously but consumes more storage space.

Recording duration

Each video segment is approximately three minutes long by default. If operations such as locking the vehicle, powering off, ejecting the USB drive, clearing videos, formatting, or switching recording views occur during recording, the recording will be interrupted. In such cases, the current video will be saved, and a new video will start recording, which may be shorter than three minutes.

Switch and status

The following methods can be used to enter the driving video setting interface and turn on/off the driving video recording:

- Tap “ → **Intelligent image** → **Driving video recording**” on the CID.
- Tap the driving video recording status icon in the top status bar of the CID .

You can enter the driving video application to view videos in the following ways:

- Tap the driving video recording status icon in the top status bar of the CID .
- Tap “ → **Driving video recording**” on the CID.



When the driving video recording is turned on and in progress



When the driving video recording is turned off





When the driving video recording is unavailable and the USB drive needs to be checked



Emergency driving recording

Automatic trigger: When the CID “**Driving video recording**” function is turned on, the vehicle will automatically start emergency recording and save the video upon detecting a collision risk.

Manual trigger: When the CID “**Driving video recording**” function is turned on, you can tap the  icon on the status bar at the top of the CID, and then tap “**Emergency recording**” in the drop-down menu, or tap the  icon (e.g., custom settings) at the bottom taskbar of the CID to record a video for emergency.

Emergency video storage location: In CID “ → **Driving video recording** → **Emergency recording**”, you can view and export the emergency videos.

USB drive detection

Only one USB drive is recognized for driving video recording at a time. Upon powering on at each time, the vehicle will prioritize the USB drive used before the previous power-off. If the

previously used USB drive is not recognized within three seconds after powering on, the vehicle will use the first USB drive detected in the reading sequence as the active drive.

Warnings, cautions and limitations

- Avoid abrupt power interruptions during recording, as this will prevent the current video from being saved.
- The driving videos are stored on a dedicated USB drive. Do not pull out the USB drive directly. If you need to pull it out, please tap “**Pop-up**” button first; otherwise, the recording video will not be saved, and the USB drive may be damaged, or the video data may be damaged or lost. Please try to avoid the use of adapters or docking stations, as they may cause unstable connections.
- When recording is turned on, videos will be recorded in a loop, with the earliest videos overwritten once storage is full. To ensure important videos are not overwritten, please export them to other devices such as mobile phones or computers in time when necessary.

Intelligent image



- For better compatibility, please use a USB drive with a capacity of 32GB or higher, USB 2.0 or above, and a write speed of 10MB/s or higher.
- Only USB drives formatted in FAT16, FAT32, or NTFS are supported. For USB drives not in the aforementioned formats, it is recommended to proactively format the drive. Formatting a USB drive will delete all its files, so save important data before formatting.
- USB drives have a limited write/erase lifespan and is considered a consumable product. If you notice slow video reading speeds or frequent video loss after six months of use, replace the USB drive with a new one.
- For your driving safety, exercise caution when viewing video content when the vehicle is running.



Adaptive Cruise Control (ACC)

Instructions for ACC

ACC can control the vehicle to follow other vehicles as per the set distance. If the preceding vehicle stops, current vehicle can stop following. If the preceding vehicle starts within 90 seconds, current vehicle can start to follow. If there is no target ahead for following, the vehicle will start and run at the set maximum cruise speed.

The ACC also has an adaptive turning cruise (ATC) function. The ATC obtains the curvature of the road ahead through cameras and maps. When the ACC is turned on and the vehicle follows the lane line or the preceding vehicle turns, the ATC improves the turning comfort and stability by adjusting the speed.

i Tips

When the ACC controls the vehicle to actively decelerate to keep a distance from the preceding vehicle, the brake light will light up;

when the ACC controls the vehicle to actively accelerate, the accelerator pedal will not move.

! warning

The ACC is only a driver assistance function and cannot cope with all traffic, weather and road conditions. As the driver of the vehicle, you are responsible for driving safety. Please hold the steering wheel at all times, observe the road conditions and take control in time in case of danger. Do not rely on this function to control the vehicle; otherwise, injury or even death may be caused.

Instrument indicators



ACC is not available.



The ACC can be activated when the ACC activation conditions are met.



ACC activated.



Maximum speed limit of ACC/LCC, and any function activated.



Maximum speed limit of ACC/LCC not activated.



System is faulty.

Activate ACC

When ACC can be activated, the indicator  on the instrument panel will illuminate.

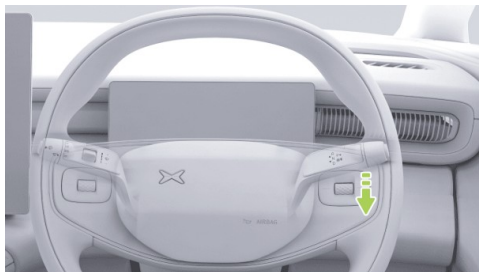

Pull the gearshift lever downward to the end once to activate the ACC, and the SR interface  will illuminate, with a voice prompt.

Tips

ACC can be activated when the following conditions are met:

- ACC-related components function normally and have a clear view.
- The wiper is not in HI mode.
- Brake pedal is not applied.



- The vehicle speed meets the requirements:
 - The vehicle speed is 30~150 km/h (without a preceding vehicle) or 0~150 km/h (with a preceding vehicle and at least 2 m from the preceding vehicle).
- There are no safety risks, including but not limited to:
 - Fasten the seat belt correctly.
 - Hold the steering wheel tightly with both hands.
 - All doors are closed.
 - The tire pressure is normal.
 - ABS, AEB and other functions not activated.
 - No drowsiness driving.

ACC cannot be activated if any of the above conditions is not met.

Set the maximum cruise speed

When ACC is activated, the maximum cruise speed can be set through the left scroll button on the steering wheel or the SAS [See 120 page](#).

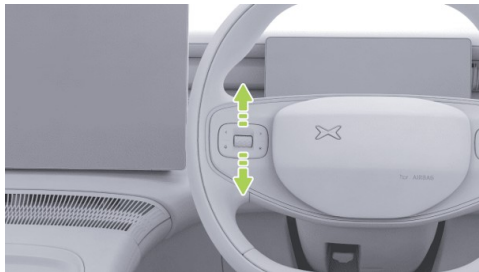

When the scroll button is rolled slowly, the maximum change rate of cruise speed is 1 km/h; when it is rolled fast, the maximum change rate is 5 km/h.

Alternatively, apply the accelerator pedal. After the vehicle speed increases, pull down and hold the gearshift lever to set the current vehicle



speed as a new cruise speed. If you do not pull up and hold the gearshift lever but release the accelerator pedal, the vehicle will decelerate to the previously set speed and continue cruising.

Tips

Cruise speed setting range: 30~150 km/h.

Alarm and take control

warning

- If the vehicle sends a control request through the SR interface , voice broadcast or other means, you shall take the control immediately.
- If any danger is found or there is a scenario that requires your control, take the control immediately, instead of waiting for the vehicle to send out a control request.

When ACC is activated, you can take the control by the following methods:

- Apply the accelerator pedal: The vehicle speed is temporarily controlled. After the

vehicle speed increases, pull down the gearshift lever to set the current speed as a new cruise speed; or release the accelerator pedal and the vehicle will decelerate to the previously set speed and continue cruising.

- Apply the brake pedal: ACC is deactivated and the vehicle decelerates.
- Pull up the gearshift lever: ACC is deactivated and energy recovery will slow down the vehicle.

In addition, when ACC is activated, if the ACC activation conditions change from satisfied to unsatisfied, ACC will exit. Please take the control.

Warnings, cautions and limitations

Please read all chapters related to ACC in this manual, and you should understand these restrictions before using the functions.

ACC is designed for driving comfort and convenience, not as a crash warning or avoidance system. The driver has the responsibility to stay vigilant at all times, ensure



driving safety and control the vehicle. Do not rely on the system to reduce the vehicle speed sufficiently to avoid crashes. Be sure to observe the road conditions ahead and be ready to take corrective measures at any time; otherwise, serious injury or even death may result.

It is your responsibility to determine and always keep a safe following distance. Do not rely solely on ACC to maintain an accurate or suitable following distance.

warning

The ACC is a driver assistance function and cannot cope with all traffic, weather and road conditions. Do not use or turn on the ACC in the following scenarios:

- Roads with twists or sharp turns and other variable road conditions (such as S-turn, continuous U-turn).
- Roads in poor conditions, such as icy or slippery roads.

- Poor weather conditions, such as heavy rain, snow and fog.
- Urban roads.

warning

ACC cannot fully respond in the following special road conditions, complex road sections, poor weather or poor light environment. Please pay attention to the environment and road conditions, raise vigilance, always put your hand on the steering wheel and take control of the vehicle at any time, including but not limited to:

- Other vehicles suddenly move or close to the front of current vehicle.
- When only part of the body of a vehicle in the adjacent lane move to the front of current vehicle (especially large vehicles such as buses and trucks).
- The vehicle ahead suddenly decelerates.
- There is a U-turn or crossing vehicle.



- When you drive in a tunnel or at night, there are trucks and buses on the side lane, or you follow a vehicle carrying extra-long goods.
- When multiple vehicles are running in parallel when approaching or turning on a road.
- For stationary vehicles or objects (such as road obstacles), especially when the front vehicle leaves your driving lane and a stationary vehicle or object appears ahead.
- The vehicle is running on a slope.
- When you increase the driving speed when going downhill, and when the vehicle exceeds the set speed or road speed limit.

warning

The ACC cannot fully identify and respond to the following environments and targets. Please pay attention to the environment and road conditions. In case of the following scenarios, please actively take control of the vehicle in time to ensure safe driving, including but not limited to:

- The vehicle encounters the following targets ahead, including but not limited to:
 - People, animals.
 - Traffic lights.
 - Walls, barricades.
 - Bicycles (bikes, motorcycles, electric vehicles, etc.), tricycles.
 - Other non-vehicle objects.
 - Targets in the sensor blind zone.
- Vehicles or objects on the other side of the ramp.
- When encountering a vehicle running in an opposite direction.
- The vehicle ahead is equipped with objects beyond its body.
- Construction, accident and other road sections.

The above warnings, cautions and limitations do not cover all conditions that may affect the normal operation of ACC.



Lane Centering Control (LCC)

Instructions for LCC

LCC is a comfortable driver assistance function, which can assist the driver to control the steering wheel and keep the vehicle centered in the current lane to the greatest extent.

When LCC is activated, ACC will be activated synchronously. The longitudinal speed and distance are controlled by ACC. LCC assists the driver in controlling the steering wheel to keep the vehicle centered within the current lane to the greatest extent on a straight road with clear lane lines on both sides and a standard curvature road.

i Tips

- When LCC is activated, ALC can be used to assist lane change .
- When LCC is activated, the cruising speed and following distance can be set by pressing the steering wheel button. The

operation method is the same as that of ACC .

! warning

The LCC is only a driver assistance function and cannot cope with all traffic, weather and road conditions. As the driver of the vehicle, you are responsible for driving safety. Please hold the steering wheel at all times, observe the road conditions and take control in time in case of danger. Do not rely on this function to control the vehicle; otherwise, injury or even death may be caused.

Instrument indicators



LCC is not available.



The LCC can be activated when the LCC activation conditions are met.



LCC activated.



The LCC will exit with a delay.



System is faulty.

Opening and closing

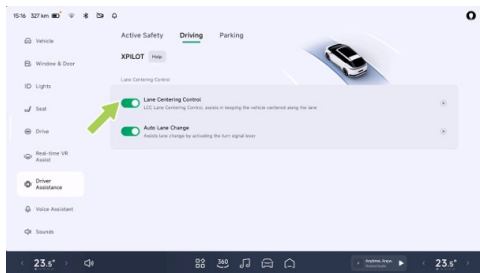

On the “ → **Driver Assistance** → **Driving**” interface of the CID, you can turn on/off “**Lane Centering Control**”.

Activate the LCC

When LCC can be activated, the indicator on the instrument panel will illuminate.

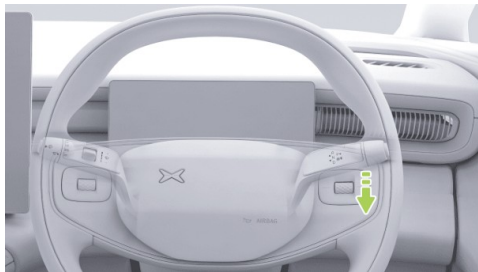

Pull the gearshift lever downward to the end twice to activate the LCC, and the SR interface will illuminate.

Tips

LCC can be activated when the following conditions are met:



- LCC-related components can work normally and provide a clear view.
- The lane line is clear.
- The wiper is not in HI mode.
- Brake pedal is not applied.
- The vehicle speed meets the requirements:
 - The vehicle speed is 30~150 km/h (without a preceding vehicle) or 0~150 km/h (with a preceding vehicle and at least 2 m from the preceding vehicle).
- There are no safety risks, including but not limited to:
 - Fasten the seat belt correctly.
 - Hold the steering wheel tightly with both hands.
 - All doors are closed.
 - The tire pressure is normal.
 - ABS, AEB and other functions not activated.
 - No drowsiness driving.

LCC cannot be activated if any of the above conditions is not met.

Alarm and take control

warning

- If the vehicle sends a control request through the SR interface, voice broadcast or other means, you shall take the control immediately.
- If any danger is found or there is a scenario that requires your control, take the control immediately, instead of waiting for the vehicle to send out a control request.

For adjusting cruise speed and following distance by LCC, refer to the descriptions of “**Set Maximum Cruise Speed**” and “**Set Following Distance**” in ACC mode.

When the LCC is activated, you can take over the vehicle by the following methods:

- Turn the steering wheel: temporarily control the steering wheel, and after the vehicle



is changed to a new lane, LCC can be automatically reactivated.

- Apply the accelerator pedal: temporarily control the vehicle speed.
- Apply the brake pedal to disable the ACC and LCC.
- Pull up the gearshift lever to disable the ACC and LCC.

In the following scenarios, the LCC will be downgraded to the ACC. Get ready to take control of the vehicle:

- The lane line is not clear.

If the current state of the vehicle does not meet the ACC activation conditions, LCC will exit directly.

Warnings, cautions and limitations

Please read all the contents about the LCC in this manual, and you should understand these restrictions before using the function.

The LCC is designed for driving comfort and convenience, and cannot cope with sudden dangerous situations. The driver has the responsibility to stay vigilant at all times, ensure driving safety and control the vehicle. Do not rely on the system to deal with sudden emergencies. Be sure to observe the road conditions ahead and be ready to take corrective measures at any time; otherwise, serious injury or even death may result.

warning

LCC cannot cope with all traffic, road conditions and weather. Please do not use or turn on LCC in the following scenarios:

- Roads with twists or sharp turns and other changeable road conditions.
- At the merging or diverging points of roads.
- Constructed or modified roads.
- When the lane line disappears or is discontinued.



- When the lane line is blurred, disappears or is covered.
- Roads with sharp changes in the direction of the lane line ahead, such as road diversion, lane merging and sudden increase or decrease of lane width.
- Roads in poor conditions, such as bumpy, icy or slippery roads.
- Urban roads.
- At a traffic intersection.
- When the preceding vehicle turns or there is a vehicle passing through in front of current vehicle.
- Road sections where pedestrians or cyclists may be present.
- When the weather is bad, such as rain, snow and fog.
- When the vehicle is in poor conditions, such as abnormal four-wheel alignment and abnormal tire pressure.

warning

LCC cannot fully respond in the following special road conditions, complex road sections, poor weather or poor light environment. Please pay attention to the environment and road conditions, raise vigilance, always put your hand on the steering wheel and take control of the vehicle at any time, including but not limited to:

Special road conditions or complex sections:

- On inclined roads, or uphill and downhill sections.
- High-speed turning or sharp turning section.
- There are scenarios of road barriers/curbs/zebra crossings/arrows at intersections.
- There are no lane lines or the lane lines are excessively worn, blocked, covered or disappeared.
- The road markings are temporarily adjusted or change rapidly (such as lane diverging,



crossing or merging) due to road construction.

- Special lane change scenarios such as lane diversion, diverging, diversion area and lane widening.
- There are words or traffic signs on the road surface, or there are dense words, traffic signs, asphalt oil, brake marks, tire prints, ruts and other disturbing objects in the lane.
- The lane is too wide or narrow.
- Road boundary separated by traffic cones, water filled barriers and cement piers.

Complex road conditions:

- When driving on a congested road.
- Roads where pedestrians or cyclists may be present.
- When other vehicles pass in front of current vehicle.
- Suddenly, a vehicle changes lane and runs to the front of current vehicle with little distance.

- When the preceding vehicle leaves the lane current vehicle is on.
- The vehicle ahead obstructs the view of the camera or blocks the lane line.
- There are large vehicles such as trucks and buses on the side or ahead.

Poor weather or light conditions:

- Objects or landscape features are casting strong shadows on lane markers.
- When strong light (such as oncoming headlight light or direct sunlight) obstructs the camera view.
- The windscreen blocks the view of the camera (water mist, dust or stickers).
- When there is a large transverse airflow or strong wind on one side of the vehicle.

Limited radar or camera:

- Radar limited .
- Camera limited .



- The radar or camera is blocked (dust, cover, etc.), or the weather conditions are poor (such as heavy rain, snow and fog).

warning

The LCC cannot fully identify and respond to the following environments and targets. Please pay attention to the environment and road conditions. In case of the following scenarios, please actively take control of the vehicle in time to ensure safe driving, including but not limited to:

- Totally rely on this system.
- Use it when the lane line is not clear or the light conditions are poor.
- Use it in an environment with many pedestrians, cyclists or animals.
- Hands off the steering wheel.
- Look away from the road of travel.
- When there is a barrier, isolation belt or curb on one side of the road.

- Occasionally, LCC will assist the vehicle to turn when steering assistance is not required or you do not intend to turn due to unclear and irregular lane lines or other lines or objects similar to lane lines on the lane surface. In this case, you should take control of the vehicle.

The above warnings, cautions and limitations do not cover all conditions that may affect the normal operation of LCC.

Assisted Lane Change (ALC)

Instructions for ALC

When the LCC is activated and the turn signal is turned on, the ALC can assist the driver in changing lanes.

Tips

On expressways, the available speed for ALC is 65~150 km/h; on urban roads, the available speed for ALC is 15~150 km/h.



⚠ warning

The ALC is only a driver assistance function and cannot cope with all traffic, weather and road conditions. As the driver of the vehicle, you are responsible for driving safety. Please hold the steering wheel at all times, observe the road conditions and take control in time in case of danger. Do not rely on this function to control the vehicle; otherwise, injury or even death may be caused.

Opening and closing

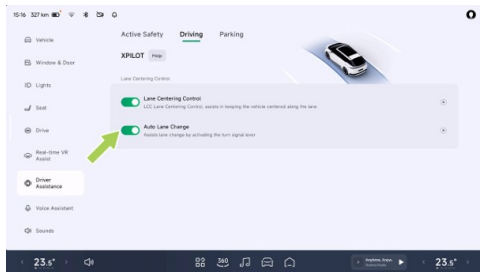

On the “**Driver Assistance**→**Driving**” interface of the CID, you can turn on/off “**Auto Lane Change**”.

Use of ALC



1. Check the lane change environment to confirm the safety of lane change.
2. Turn on the turn signal on corresponding side.
3. If the conditions for ALC lane change are met, ALC will assist the driver with lane changing. If the conditions are not met, a prompt will



be provided through the SR interface [See 54 page](#).

i Tips

- ALC can only change one lane at a time. If you need to change the lane once more, please turn on the turn signal on the corresponding side again.
- The ALC cannot change lanes across solid lines.
- When ALC judges that lane change is not suitable at present, the parking space box of the target lane on the SR interface will be gray. When a lane change is canceled, the SR interface will display “**Lane Change Canceled**” for prompting.
- After the lane change is completed or canceled by ALC, the turn signal will be automatically turned off.

Alarm and take control

! warning

- If the vehicle sends a control request through the SR interface , voice broadcast or other means, you shall take the control immediately.
- If any danger is found or there is a scenario that requires your control, take the control immediately, instead of waiting for the vehicle to send out a control request.

After the ALC is activated, the lane change can be canceled by the following operations:

- Turn the steering wheel: cancel lane change and temporarily control the steering wheel. After conditions are met, LCC will be reactivated.
- Apply the brake pedal: Cancel the lane change and exit the ACC and LCC.



Warnings, cautions and limitations

The ALC is a driver assistance function and cannot realize autonomous driving. When the ALC is activated, the driver still needs to observe the safety of lane change environments to take control of the vehicle in time when there is potential danger.

The ALC is designed for driving comfort and convenience, and cannot cope with sudden dangerous situations. The driver has the responsibility to stay vigilant at all times, ensure driving safety and control the vehicle. Do not rely on the system to deal with sudden emergencies. Always observe the road ahead and be prepared to take corrective action at any time, as failure to do so could result in serious injury or even death.

The ALC may drop out unexpectedly at any time for unknown reasons. Be sure to observe the road safety situation and be ready to take appropriate measures. The driver is always responsible for safety in the lane change.

warning

Please read all the contents about the ALC in this manual, and you should understand these restrictions before using the function.

- The ALC cannot cope with all traffic, weather and road conditions. Do not use it in bad weather (such as rain, snow and fog) or on roads where pedestrians or cyclists may be present.
- Do not use the ALC when there are vehicles in front of the current vehicle or in adjacent lanes, as it may cause crashes with other vehicles.
- During the use of the ALC, if another vehicle changes its lane into a lane that the current vehicle is changing into at the same time, the function cannot avoid the crash risk at this moment. The driver should always observe the safety of lane change and timely intervene in vehicle control to avoid crashes. The driver is fully responsible for the safety of lane change.



- Do not use the ALC when the vehicle is in poor conditions, such as abnormal four-wheel alignment and abnormal tire pressure.
- Do not use the ALC at the ramp, confluence and diversion of expressways or other roads.
- Use the ALC with caution in turning sections, because the system may not be able to support lane change assistance.
- Do not use the ALC on urban roads or under changeable road conditions.
- Do not use the ALC on winding roads with sharp bends, bumpy, icy or slippery roads. The system cannot stably provide lane change assist under these poor road conditions.
- Occasionally, the ALC will recognize the lane change conditions as lane change not allowed. In this case, you need to manually change lanes.
- On road sections with heavy traffic, the ALC may not be able to accurately detect the lane change environment. Please use the ALC carefully.
- Do not use the ALC in sections with solid lane markings or other lane change restrictions.
- When the ALC is used, if other vehicles approach the current vehicle quickly, the driver must take control immediately. The ALC cannot avoid possible crashes.
- Do not use ALC when there are other vehicles in the side rear blind spot of current vehicle or on the lane change route.
- The road has sharp curves or poor road conditions such as bumpy, slippery or icy surfaces.
- On a sloped road.
- Roads where pedestrians or cyclists may be present.
- Darkness (poor lighting) or poor visibility (caused by heavy rain, snow, fog, etc.).



- When strong light (such as oncoming headlight light or direct sunlight) obstructs the camera view.
- The vehicle ahead obstructs the view of the camera.
- The windscreen blocks the view of the camera (water mist, dust or stickers).
- The lane lines are excessively worn, shielded or covered; the new and old road markings overlap; the road markings are temporarily adjusted or change rapidly (such as lane diverging, crossing or merging) due to road construction.
- Objects or landscape features projected onto the driveway creating large areas of shadow.
- Warning cones, warning signs or other objects are placed on the road surface.
- Radar limited .
- The radar or camera is blocked (dust, cover, etc.), or the weather conditions are poor (such as heavy rain, snow and fog).

- When there is strong transverse airflow or gale on one side of the vehicle, ALC performance will be affected, and thus this function is not suitable for use in such weather.

The above warnings, cautions and limitations do not cover all conditions that may affect the normal operation of the ALC.



Auto Park Assist (APA)

Instructions for APA

APA can assist the driver with parking in and pulling out [See 94 page](#) vertical, parallel, angled parking spaces with or without line markings, and dead-end parking spaces. The following activation methods are supported:

- CID
- Phone key

warning

The APA is only a driver assistance function and cannot cope with all traffic, weather and road conditions. As the driver of the vehicle, you are responsible for driving safety. Please hold the steering wheel at all times, observe the road conditions and take control in time in case of danger. Do not rely on this function to control the vehicle; otherwise, injury or even death may be caused.

Instrument indicators



The APA can be activated



APA activated



APA unavailable

Opening and closing

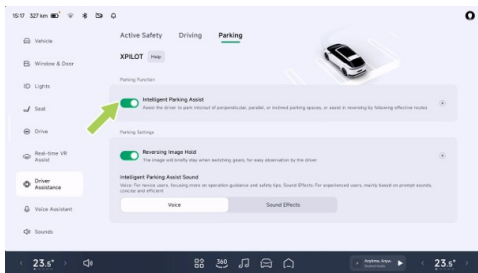

Assisted parking



On the “**Driver Assistance**→**Parking**” interface of the CID, you can turn on/off APA.

Use of APA



1. The parking mode will be initiated on the “**All-domain Intelligent Driving**” interface by using any of the following methods:
 - Automatic switching. When the vehicle enters a parking environment such as a basement, the “**All-domain Intelligent Driving**” will automatically enter the parking mode.

- Press the steering wheel shortcut key [See 234 page](#).
- Tap “**Park**” on the CID.
- When the SR interface in the middle of the instrument displays the parking space icon, stop and switch to R position.

2. Drive to find the target parking space.

i Tips

- In the process of searching for a parking space, please keep the lateral distance between your vehicle and the parking space within 1~2m.
- In the process of searching for parking space, the vehicle speed shall not exceed 24 km/h.

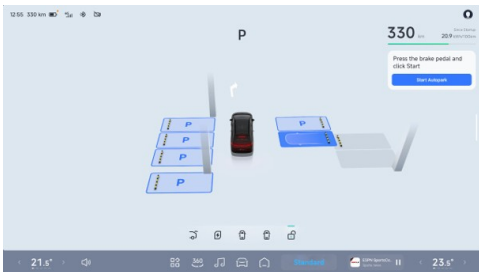

3. When the target parking space is highlighted, apply the brake pedal and tap on the CID to select the target parking space.
4. At this time, you can park in the parking space by the following methods:
 - CID: Tap **"Start parking"** on the CID, and then release the brake pedal.
 - Phone key: Shift to P gear, get out of the vehicle and close the doors. Open the intelligent parking module of the mobile App, tap **"Remote Parking"**, and tap and hold the parking button after the exterior

rearview mirrors are folded and the hazard warning lights are turned on.

i Tips

- After parking in the parking space with a phone key, the vehicle will be automatically switched to P gear, locked and powered off.
- When parking in the parking space with a phone key, keep the mobile phone near the vehicle; otherwise, the function will exit.
- When the vehicle is parked in a parking space with a phone key, it is allowed to open the door/trunk to pick up objects within five minutes after remote parking is paused. After picking up objects, you can tap "Continue" to complete remote parking.



Alarm and take control

warning

- If the vehicle sends a control request through the instrument, voice prompt and other means, you shall immediately take over the vehicle.
- If any danger is found or there is a scenario that requires your control, take the control immediately, instead of waiting for the vehicle to send out a control request.
- Please make sure that there is no one in the vehicle before parking in the parking space through mobile APP.

When the APA is activated, it can be paused in the following ways:

- Parking with CID: Apply the brake pedal at any time to suspend the APA.
- Parking with phone key: Release the parking button on the mobile App page.

When safety is confirmed, the APA can be restored by:

- Parking on the CID: Tap “**Continue**” on the CID.
- Parking with phone key: Tap and hold the parking button on the mobile App.

The APA will exit if:

- you turn the steering wheel manually.
- you apply the brake pedal to shift gears.
- when the APA has been paused for more than 30s and has not recovered, and remote parking with the mobile has been paused for more than 5 min and has not recovered.
- the door is opened, the accelerator pedal or the brake pedal are applied, causing APA to pause 3 times.

Warnings, cautions and limitations

warning

Do not use APA in the following scenarios:

- The road is a ramp.



- One or more ultrasonic sensors and panoramic cameras are stained or obstructed (such as mud, ice, snow or water).
- Unfavorable climatic conditions (such as heavy rain, snow and fog).
- The road surface is uneven, icy or slippery.
- The curb is not made of stone or cannot be detected.
- Road surface with height difference (such as cliff edge, high platform and sidewalk facing the street).
- A tire chain or spare wheel is installed.
- The loaded object protrudes from the vehicle.
- Any of the left and right exterior rearview mirrors is damaged or in an abnormal position.
- Parking spaces on narrow streets, or narrow parking spaces.
- Normal operation of the vehicle functions will be affected if the vehicle is refitted or

repaired at a service center other than the XPENG Service Center.

warning

In the following scenarios, the APA may not be able to take safety measures and you shall immediately take control of the vehicle:

- When the SR interface sends you a takeover request.
- When the APA exits unexpectedly.
- Encountering vehicles, pedestrians and objects during parking without timely completion of automatic avoidance or braking

warning

The following situations may occur in the APA, please get ready to take control of the vehicle:

- Obstacles at or above the height of the exterior rearview mirror.
- Suspended obstacles with small size and width.

Assisted parking



- Targets in the blind spot of camera or radar.
- Pedestrians or animals.

The above warnings, cautions and limitations do not cover all conditions that may affect the normal operation of APA.

Auto Exit Parking Assist (AEP)

Instructions for AEP

The following methods can be used to pull the vehicle out of a parking space if it has not been moved after parking with the APA [See 89 page](#).

- CID: Get on the vehicle, close the door, switch to R gear, and tap “**Start pulling-out**” on the CID.
- Phone key: Open the mobile App, tap “**Remote Parking**”, and tap and hold the pulling-out button after the exterior rearview mirrors are folded and the hazard warning lights are turned on.

Tips

The pulling-out function can only be used after the owner's account is logged in on the CID and the APA function switch is turned on.

warning

- AEP is only a driver assistance function and cannot cope with all traffic, weather and road conditions. As the driver of the vehicle, you are responsible for driving safety. Please hold the steering wheel at all times, observe the road conditions and take control in time in case of danger. Do not rely on this function to control the vehicle; otherwise, injury or even death may be caused.
- The warning precautions and alarm for the APA, and taking control of the vehicle are also applicable to the AEP.



Straight-line Calling

Instructions for Straight-line Calling

The phone key can be used to control the vehicle to move forward or backward, for vehicles to enter and exit narrow parking spaces where people cannot get on and off smoothly.

Tips

Straight-line calling has the function of obstacle avoidance. If an obstacle is encountered, it will automatically pause.

warning

Straight-line calling is only a driver assistance function and cannot cope with all traffic, weather and road conditions. As the driver of the vehicle, you are responsible for driving safety. Do not rely on this function to control the vehicle; otherwise, injury or even death may be caused.

Opening and closing

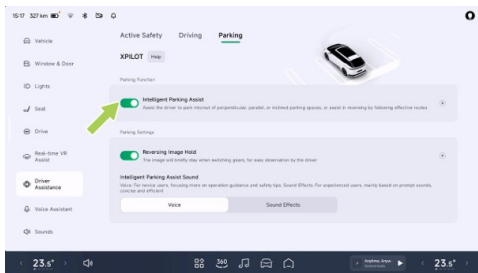

On the “→**Driver Assistance**→**Parking**” interface of the CID, you can turn on/off APA.

Straight-line calling of phone key

1. Open the mobile APP and tap “**Parking-in or Pulling-out**”. The exterior rearview mirrors fold and hazard warning lights turn on.
2. Tap and hold the switch to control the vehicle to move forward or backward. Release the switch to stop the vehicle.



3. After the vehicle enters or leaves the parking space, tap Back to exit the function.

Warnings, cautions and limitations

warning

Do not use the straight-line calling in the following scenarios:

- One or more ultrasonic sensors and panoramic cameras are stained or obstructed (such as mud, ice, snow or water).
- Unfavorable climatic conditions (such as heavy rain, snow and fog).
- The road surface is uneven, icy or slippery.
- The road is a ramp.

warning

In the following scenarios, safety measures may not be taken for straight-line calling, and you shall immediately take control of the vehicle:

- The system prompts you to take control of the vehicle.
- Encountering vehicles, pedestrians and objects during parking, without active avoidance or braking completed in time
- Straight-line calling summons unexpected exit.

warning

Do not have the following behaviors when using straight-line calling:

- Look away from the vehicle.
- Completely rely on straight-line calling for parking.

The above warnings, cautions and limitations do not cover all conditions that affect the normal operation of the straight-line calling.



Tracking reversing

Introduction

Tracking reversing is a function that assists the driver to reverse along the original route. After entering difficult road conditions such as dead ends and narrow roads, you can use tracking reversing to get out of trouble.

caution

Tracking reversing has the function of obstacle avoidance. If there is an obstacle, it will automatically pause.

warning

Tracking reversing is only a driver assistance function and cannot cope with all traffic, weather and road conditions. As the driver of the vehicle, you are responsible for driving safety. Do not rely on this function to control the vehicle; otherwise, accidents may be caused.

Operation

Opening and closing

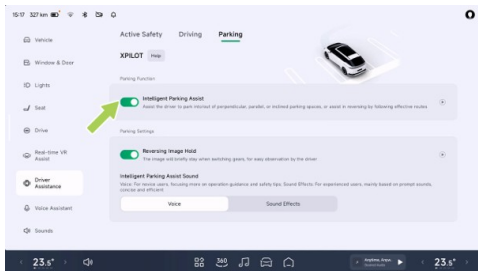

On the “→Driver Assistance→Parking” interface of the CID, you can turn on/off APA.

Use tracking reversing

1. When driving forward at a speed lower than 20 km/h, the system will automatically remember the latest available path.
2. Stop the vehicle and shift to R gear.

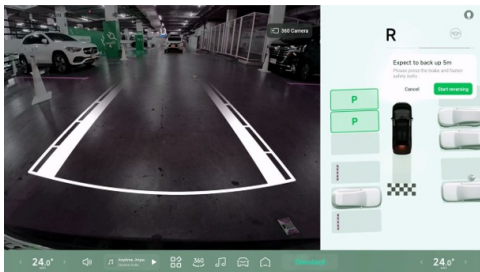

3. Tap **“Route reversing→Start route reversing”** on the CID.
4. The system will automatically reverse at a low speed according to the effective path.

caution

- The forward path in D gear below 20 km/h may be recorded as an available path, and the path can be up to 100 meters long.
- Before tracking reversing is activated, the available route will be cleared in case of

reversing, the steering wheel being turned to an excessive angle or ramp driving.

Warnings, cautions and limitations

warning

Do not use tracking reversing in the following scenarios:

- The road is a ramp.
- One or more ultrasonic sensors and panoramic cameras are stained or obstructed (such as mud, ice, snow or water).
- Unfavorable climatic conditions (such as heavy rain, snow and fog).
- The road surface is uneven, icy or slippery.
- Road surface with height difference (such as cliff edge, high platform and sidewalk facing the street).



warning

In the following scenarios, safety measures may not be taken for tracking reversing, and you shall immediately take control of the vehicle:

- The system prompts you to take control of the vehicle.
- When tracking reversing exits unexpectedly.
- Encountering vehicles, pedestrians and objects during reversing without timely completion of automatic avoidance or braking

warning

The following situations may be encountered when using tracking reversing. Please get ready to take control of the vehicle:

- Obstacles at or above the height of the exterior rearview mirror.
- Suspended obstacles with small size and width.

- Targets in the blind spot of camera or radar.
- Pedestrians or animals approaching suddenly.

warning

When using tracking reversing, do not fully rely on it.

The above warnings, cautions and limitations do not cover all conditions that affect the normal operation of the tracking reversing.



Instructions for FCW&AEB

Forward Crash Warning (FCW&AEB)

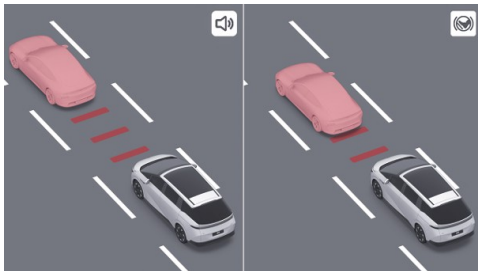

The forward crash warning includes forward crash warning (FCW) and automatic emergency stop (AEB), which can reduce the risk of vehicle crashes or reduce the speed before vehicle crashes, thus improving driving safety.

warning

The FCW does not work when the vehicle is in R gear.

When the system detects a crash risk, it will provide alerts through the SR interface [See 54 page](#) and auditory prompts.

warning

- For pedestrians and bicycles, the forward crash warning (FCW) only works when current vehicle speed is between 10 km/h and 85 km/h;
- For motor vehicles, the forward crash warning (FCW) only works when current vehicle speed is between 10 km/h and 150 km/h.
- When the vehicle gives an early warning, the driver shall immediately take emergency measures such as avoidance. Do not fully rely on AEB to avoid or mitigate crashes.



If the risk further increases, and the driver still does not brake or the braking force is too small, the vehicle will brake actively to reduce crashes and injury.

warning

- For pedestrians and bicycles, automatic emergency stop (AEB) only works when current vehicle speed is between 4 km/h and 85 km/h;
- For motor vehicles, automatic emergency stop (AEB) only works when current vehicle speed is between 4 km/h and 150 km/h.
- If AEB stops the vehicle, the vehicle will remain stationary for a short time, and the driver should brake as soon as possible.
- In the process of AEB intervention in vehicle braking, application of the accelerator pedal may cause brake interruption.

warning

- FCW is an assist function, which cannot work in all driving, traffic, weather and

road conditions and cannot replace focused driving and accurate judgment. Thus, the driver bears full responsibility for driving safety. Always observe the road conditions during driving, and do not rely on FCW to warn or avoid a possible crash. Many factors can reduce or affect performance, leading to unnecessary, inaccurate or ineffective warnings, brake interventions or omission warnings. Relying on the FCW for warning or avoiding a potential crash may result in serious personal injury or even death.

- Automatic emergency stop is not designed to prevent crashes. At best, it can only minimize the impact of a frontal crash by trying to reduce driving speed. Relying on the AEB to avoid crashes may cause serious personal injury or even death.

Instrument indicators



FCW OFF



FCW fault

Opening and closing

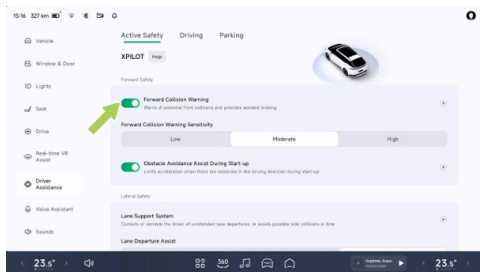

On the “**Driver Assistance**→ **Active Safety**” interface of the CID, you can turn on/off “**Forward Collision Warning**”. After this function is enabled, you can set the forward crash warning sensitivity.

i Tips

The FCW will be turned on automatically every time the vehicle is driven. For your safety, it is recommended to keep it always on.

Warnings, cautions and limitations

Before using FCW, the driver should refer to this chapter for guidance and restrictions on use of relevant functions.

! warning

In the following scenarios, the FCW function may be limited or unable to work. Do not fully rely on this function:

- Radar or camera limited .
- In darkness or poor visibility. For example, poor lighting conditions, heavy rain, heavy snow and dense fog.
- When strong light obstructs the camera field of view. For example, oncoming headlight light or direct sunlight.



- The windscreen blocks the view of the camera (water mist, dust or stickers).
- There is a vehicle running in the wrong direction ahead.
- Current vehicle is running on a road with large curves or roads in poor conditions.
- The target suddenly appeared. For example, other vehicles suddenly move quickly or close to the front of current vehicle.
- The target overlap rate (overlap between front end width of current vehicle and rear end width of the preceding vehicle) is insufficient.
- The driver applies the brake, depresses the accelerator pedal deeply, or rotates the steering wheel rapidly or greatly.
- There are stationary vehicles at the entrance and exit of curves.
- The vehicle is running in a curve and the adjacent vehicle suddenly decelerates.
- There is a vehicle overtaking in front at the curve.

- The vehicle is passing a stationary roadside target or overtaking during lane change.
- The preceding vehicle changes the lane after braking.
- The vehicle passes by a speed bump, floor drain or iron gate in the garage.
- The vehicle passes under a flyover, pedestrian overpass or destination sign.
- The vehicle passes through flyover joints, metal guardrails on the roadside and other scenarios.
- There are traffic lights, water columns of sprinklers, splashing water spots, iron pillars on the road surface, air steel pipes, floating plastic bags, zip-top cans rolling on the road surface, underground parking garages, highway toll stations, manhole covers, etc.

The above warnings, cautions and limitations do not cover all conditions that may affect the normal operation of FCW&AEB.



Start obstacle avoidance assist

Instructions for Obstacle Avoidance Assist

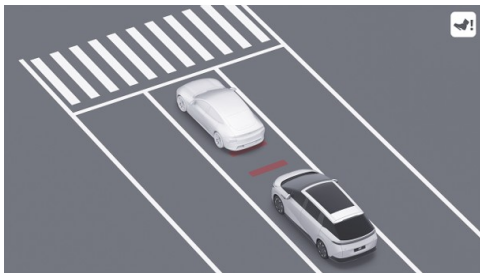

Start Obstacle Avoidance: When the vehicle starts, if an obstacle is detected in the driving direction and the driver depresses the accelerator pedal too fast, the dynamic response of the vehicle will be limited to avoid a crash with the obstacle due to too fast acceleration of the electric vehicle.

warning

The start obstacle avoidance assist function is only an auxiliary driving function and cannot replace direct visual observation. Do not excessively rely on the start obstacle avoidance assist function. When the function is activated, the acceleration of the vehicle will be limited to a certain extent only. You still need to actively control and brake the vehicle; otherwise, a crash may still occur. It is your responsibility to be vigilant, pay attention to the environment where the vehicle starts and always keep an eye on other road users; otherwise, serious injuries or even death may result.



Opening and closing

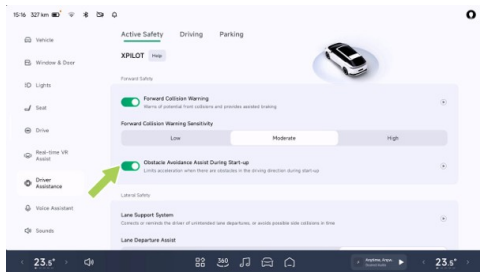

On the “**Driver Assistance→Active Safety**” interface of the CID, you can turn on/off “**Obstacle Avoidance Assist During Start-up**”.

Warnings, cautions and limitations

warning

The start obstacle avoidance assist function may not always work under various conditions. There are many reasons that may lead to

unnecessary, inaccurate or invalid warnings or missed warnings, such as:

- Radar limited .
- There is a moving metal object with large volume in the blind area.
- The speed of the detected object is too high.

The above warnings, cautions and limitations do not cover all conditions that may affect the normal operation of start obstacle avoidance assist.



Blind Spot Assist (BSD)

Instructions for Blind Spot Safety Assist BSD

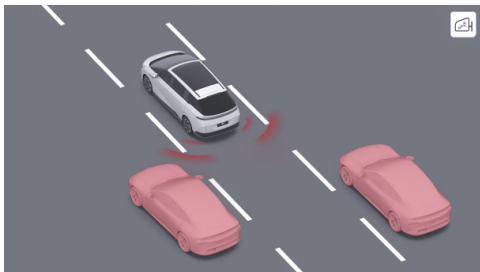

The blind spot safety assist includes blind spot detection (BSD) and lane change alert (LCA), which can monitor the lanes on both sides of the vehicle and give a warning when there is a risk of lane change.

When the vehicle is in D gear and current vehicle speed is greater than 10 km/h, if there is a

vehicle in the blind spot or a quickly approaching vehicle behind the blind spot, the warning light on the corresponding exterior rearview mirror will be normally on. At this time, if the turn signals on corresponding side are turned on, the warning light on the exterior rearview mirror will flash to give a warning.

⚠ warning

Blind spot safety assist is only a driver assistance function and cannot cope with all traffic, weather and road conditions. It cannot replace the driver's focused driving and accurate judgment, nor can it replace the use of interior and exterior rearview mirrors. As the driver of the vehicle, you are responsible for driving safety and it is always your responsibility to change lanes in a safe manner. Do not rely on this function to control the vehicle; otherwise, injury or even death may be caused.



Opening and closing

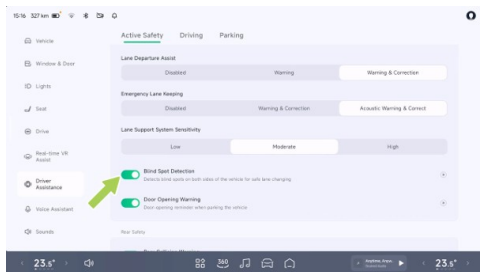

On the “**Driver Assistance**→**Active Safety**” interface of the CID, you can turn on/off “**Blind Spot Detection**”.

Warnings, cautions and limitations

warning

The blind spot safety assist may not work properly in the following scenarios:

- Radar limited .
- Sharp curves.

- Reversing.
- There is a moving metal object with large volume in the blind area.

The above warnings, cautions and limitations do not cover all conditions that may affect the normal operation of the blind spot safety assist.

Door Opening Warning (DOW)

Instructions for DOW

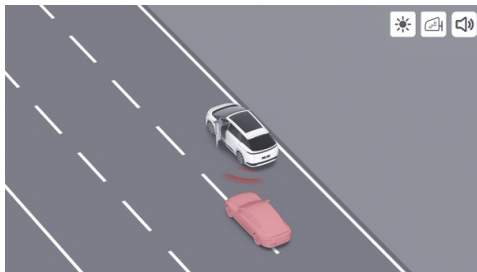

Active safety



When there is a risk of crashes when the door is opened, DOW can remind the driver and passengers.

When current vehicle speed is 0~5 km/h, there are vehicles, pedestrians and bicycles approaching at a certain speed within the detection range and there is a risk of crashes when the door is opened, DOW will give a warning in the following ways:

- SR interface [See 54 page](#).
- Prompt tone.
- The warning light of the corresponding exterior rearview mirror is normally on.
- The ambient lights of the front and rear doors on the corresponding side flash in orange red.

warning

DOW is only an auxiliary driving function, which aims to remind the driver and passengers to pay attention to the safety of the door opening environment when opening the door. It cannot cope with all traffic, weather and road

conditions, nor replace the visual observation by the driver and passengers, as well as the function of the interior and exterior rearview mirrors. As the driver of the vehicle, you are responsible for driving safety. Do not rely on this function to control the vehicle; otherwise, injury or even death may be caused.

Opening and closing

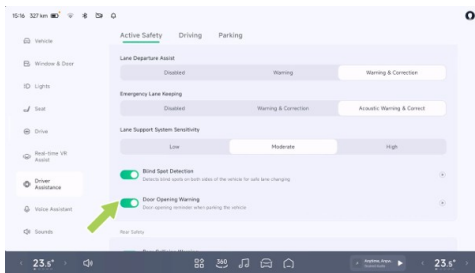

On the “**Driver Assistance**→**Active Safety**” interface of the CID, you can turn on/off “**Door Opening Warning**”.



Warnings, cautions and limitations

warning

The DOW may not work properly in the following scenarios:

- Radar limited .
- Smaller targets or stationary targets.
- The target speed is too fast or there is steering behavior. For example, the target vehicle changes lane to the rear of current vehicle, and other vehicles suddenly change lanes behind current vehicle in the detection area.
- Other vehicles or cyclists behind current vehicle.
- Current vehicle stops at a turning or beside a wall.

The above warnings, cautions and limitations do not cover all conditions that may affect the normal operation of DOW.

Rear Crash Warning (RCW)

Instructions for RCW

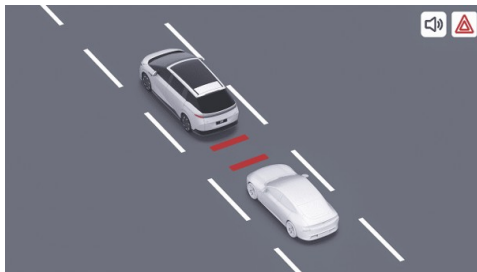

During driving, RCW can detect and warn the crash risk behind the vehicle.

When current vehicle speed is 15~160 km/h, there are vehicles, pedestrians and bicycles approaching at a certain speed within the detection range and there is a risk of crashes, RCW will give a warning through the SR interface [See 54 page](#) and prompt sound, and remind you





of the vehicles behind by turning on the hazard warning light.

warning

The RCW is only a driver assistance function and cannot cope with all traffic, weather and road conditions. It cannot replace the driver's focused driving and accurate judgment, nor can it replace the use of interior and exterior rearview mirrors. As the driver of the vehicle, you are responsible for driving safety. Do not rely on this function to control the vehicle; otherwise, injury or even death may be caused.

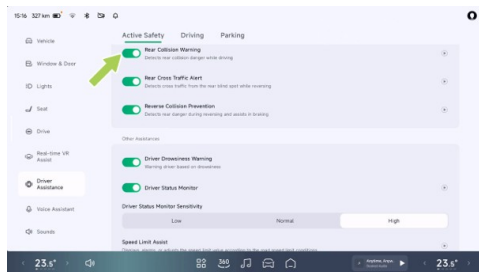
Opening and closing



On the “→Driver Assistance→ Active Safety” interface of the CID, you can turn on/off “Rear Collision Warning”.

Warnings, cautions and limitations

warning

The RCW may not work properly in the following scenarios:

- Radar limited .



- The speed of the detected object is too high.
- There is a moving metal object with large volume in the blind area.
- Sharp curves.

The above warnings, cautions and limitations do not cover all conditions that may affect the normal operation of RCW.

Rear Cross Traffic Alert (RCTA)

Instructions for RCTA

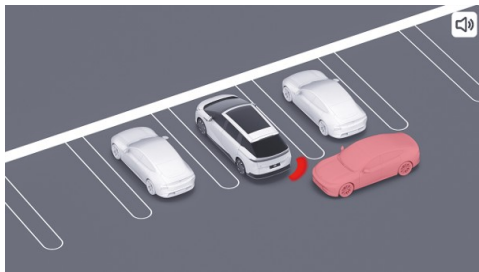

When the reversing vision is limited, RCTA can remind the driver of the approaching vehicles in the blind spots on both sides behind.

When the vehicle is in R or N gear, moving at a reverse speed of 2~15 km/h, and a vehicle, pedestrian, or two-wheeler is detected approaching at a certain speed within the detection range posing a crash risk, RCTA is





activated, and alerts will be provided via the SR interface [See 54 page](#) and auditory prompts.

warning

RCTA is only a driver assistance function and cannot cope with all traffic, weather and road conditions. It cannot replace the driver's focused driving and accurate judgment, nor can it replace the use of interior and exterior rearview mirrors. Do not take a risk of driving because the system improves comfort. It is always the driver's responsibility to reverse in a safe manner. Please do not rely on this function to control the vehicle; otherwise, injury or even death may be caused.

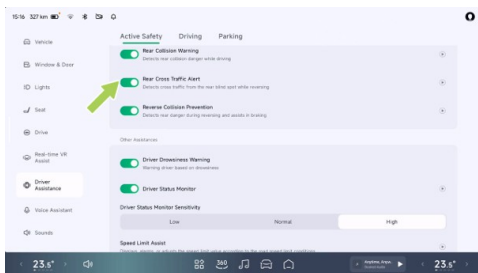
Opening and closing



On the “→**Driver Assistance**→**Active Safety**” interface of the CID, you can turn on/off “**Rear Cross Traffic Alert**”.

Warnings, cautions and limitations

warning

Do not use RCTA in the following scenarios:

- Restricted field of vision.



- Complex traffic conditions, such as roads with large traffic flow and crossing multiple carriageways.

warning

The RCTA may not work properly in the following scenarios:

- Radar limited .
- The speed of the detected object is too high.
- There is a moving metal object with large volume in the blind area.

warning

The following situations may occur in the RCTA:

- Pedestrians and bicycles are not accurately identified.

The above warnings, cautions and limitations do not cover all conditions that may affect the normal operation of RCTA.

Reversing Collision Prevention (RCP)

Instructions for RCP

Introduction

During reversing, the driver assistance system will detect whether there are pedestrians standing or crossing behind within the driving range of this vehicle and may crash with this vehicle. In this case, the RCP system will assist the driver in braking to prevent or reduce crash damage. At the same time, the system will also send feedback to road traffic participants outside the vehicle through brake lights to remind them to avoid the vehicle.

warning

The RCP is only a driver assistance function and cannot cope with all traffic, weather and road conditions. It cannot replace the driver's focused driving and accurate judgment, nor can it replace the use of interior and exterior rearview mirrors. As the driver of the vehicle, you are responsible for driving safety. Do not

Active safety



rely on this function to control the vehicle;
otherwise, injury or even death may be caused.

Function Activated

When the vehicle is in R/N gear, the vehicle speed is 1~12 km/h, and there are vehicles, pedestrians, and two-wheeled vehicles approaching at a certain speed within the detection range, and there is a risk of collision, the RCP will be activated and an alert will be sent via ICM or warning sound.

If the driver fails to brake in time or the braking force is too small, the RCP will be activated to reduce or avoid injuries in a vehicle collision.

caution

If the RCP stops the vehicle, the vehicle will remain stationary for a while and the driver should take over braking as soon as possible.

Operation

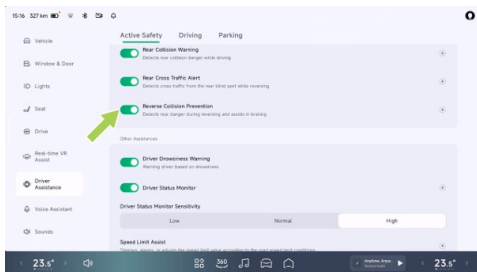

On the “→Driver Assistance→Active Safety” interface of the CID, you can turn on/off “Reverse Collision Prevention”.

Warnings, cautions and limitations

warning

The RCP may not work properly in the following scenarios:

- Radar is limited.



- The speed of the detected object is too high.
- There is a moving metal object with large volume in the blind area.

The above warnings, cautions and limitations do not cover all conditions that may affect the normal operation of RCP.

Lane Support Systems (LSS)

Instructions for LSS

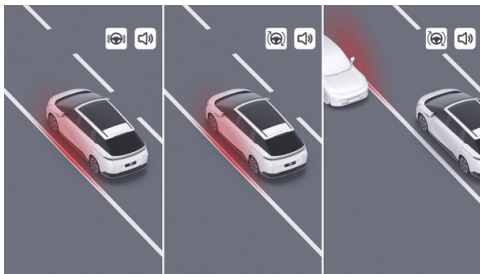

The LSS includes lane departure warning (LDW), lane keeping assist (LKA) and emergency lane keeping assist (ELK), which can warn and correct unconscious lane departure or possible lateral crash in case of emergency avoidance.

warning

The LSS is only a driver assistance function and cannot cope with all traffic, weather and road conditions. It cannot replace the driver's dedicated driving and accurate judgment. As the driver of the vehicle, you are responsible for driving safety. Do not rely on this function to control the vehicle; otherwise, injury or even death may be caused.

If the early warning mode is selected, only LDW will be turned on; if the correction mode is selected, all LDW, LKA and ELK will be turned on:

- LDW: When the current vehicle speed is 60~150 km/h and the vehicle deviates from the lane without the corresponding turn signals on, the function will give a warning through the SR interface [See 54 page](#), prompt



sound and steering wheel vibration until the driver corrects the vehicle position.

warning

LDW only has a reminding function and cannot make the vehicle back to the lane. Please correct the vehicle position in time when LDW gives an alarm.

- LKA: When the current vehicle speed is 60~150 km/h and the vehicle deviates from the lane without the corresponding turn signals on, the LKA will give a warning through the SR interface [See 54 page](#) and prompt sound, and intervene in steering wheel control to correct the vehicle back into the lane.
- ELK: When the current vehicle speed is 60~150 km/h and the vehicle is about to crash with the curb, oncoming vehicles or overtaking vehicles, the ELK will give a warning through the SR interface [See 54 page](#) and prompt sound, and intervene in steering wheel control for emergency avoidance.

caution

- When the turn signal is on or the driver has obvious steering intention (such as turning the steering wheel quickly, braking, applying the accelerator pedal deeply to accelerate, and turning on the hazard warning light), the LSS function will not give an alarm or interfere with lane departure.
- The activation of this function will be suppressed by the wipers and hazard warning light.



Set the LSS

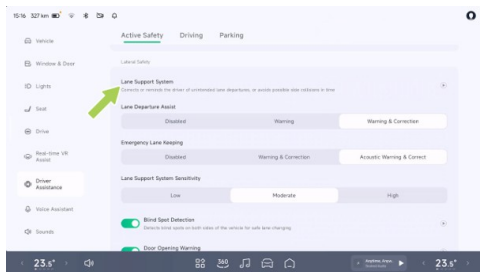

On the “**Driver Assistance**→**Active Safety**” interface of the CID, you can set the assistance mode and triggering conditions of the Lane Departure Assist (LDA).

If Lane Departure Assist is set to Warning, only LDW will be turned on; if it is set to Warning & Correct, LKA will be turned on.

i Tips

If the ELK function is deactivated, it will be deactivated again the next time the vehicle is powered on.

Warnings, cautions and limitations

! warning

The LSS may not work properly in the following scenarios:

Special road conditions or complex sections:

- The lane lines are excessively worn; the new and old road markings overlap; the road markings are temporarily adjusted or change rapidly (such as lane diverging, crossing or merging) due to road construction.

Poor weather or light conditions:

- When there is a large transverse airflow or strong wind on one side of the vehicle.
- Darkness (poor lighting) or poor visibility (caused by heavy rain, snow, fog, etc.).



- When strong light (such as oncoming headlight light or direct sunlight) obstructs the camera view.
- Objects or landscape features are casting strong shadows on lane markers.
- The lane line cannot be identified or is incorrectly identified due to light reasons, such as reflection of the lane line caused by strong illumination, poor visibility or insufficient lighting caused by bad weather and night.

Camera limited:

- Camera limited .
- The camera is blocked (dust, cover, etc.).
- There is a vehicle ahead that may block the camera field of view.

The following situations may occur in the LSS:

- Give early warning or apply braking when there is no risk of crashes.

The above warnings, cautions and limitations do not cover all conditions that may affect the normal operation of LSS.

Traffic Sign Recognition (TSR)

Instructions for TSR

The TSR can identify speed limit signs on the road and obtain speed limit information based on navigation, which is displayed on the displayed on the SR interface [See 54 page](#). The TSR will also give a warning when the vehicle is speeding.

Speed limit reminder

TSR can identify the speed limit from road signs and intelligent traffic violation monitoring systems, and give a reminder of different icons:



Speed limit on the speed limit sign



Tips

The traffic signs that TSR can identify include: speed limit signs, variable speed limit signs, speed limit cancellation signs, regional speed limit signs, multi-lane speed limit signs, multi-speed limit signs, and expressway exit ramp speed limit signs.

Overspeed alarm

When the TSR identifies a road speed limit:

- For manual driving, ACC/LCC: When the road speed limit is greater than or equal to 60 km/h and the speed exceeds about 20%, the speed limit icon on the instrument will flash 3 times for reminding.

warning

The TSR is only a driver assistance function and cannot cope with all traffic, weather and road conditions. As the driver of the vehicle, you are responsible for driving safety. Do not

rely on this function to control the vehicle; otherwise, injury or even death may be caused.

Operation

On the “→Driver Assistance→Active Safety” interface of the CID, you can set “Speed Limit Assist”.

- When you select the Display mode for Speed Limit Assist, only the icon flashes to give an alarm.
- When you select the Alarm mode for Speed Limit Assist, and turn on Beeps. There will be a prompt tone every time the speed limit changes.
- When you select the Alarm mode for Speed Limit Assist, and turn on Alarm Sound. There will be a prompt tone for each overspeed.

Warnings, cautions and limitations

warning

The TSR may not work properly in the following scenarios:

Active safety



- Radar or camera limited .
- When the road or speed limit sign is changed recently.
- When traffic signs are in poor condition.

The above warnings, cautions and limitations do not cover all conditions that may affect the normal operation of TSR.

Intelligent Speed Limit Assist (SAS)

Instructions for SAS

The SAS can set the maximum cruise speed synchronously with the road speed limit identified by TSR.

warning

The SAS is only a driver assistance function and cannot cope with all traffic, weather and road conditions. As the driver of the vehicle, you are responsible for driving safety. Do not rely on this function to control the vehicle; otherwise, injury or even death may be caused.

Opening and closing

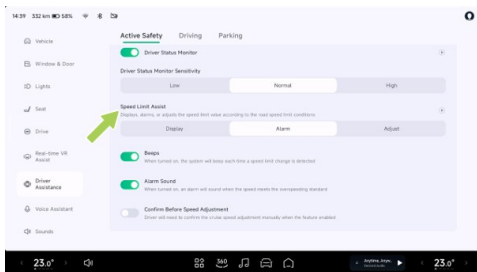

On the “→Driver Assistance→Active Safety” interface of the CID, you can set the SAS assistance mode.

- When you select Adjust for Speed Limit Assist and turn on Confirm Before Speed Adjustment and if ACC/LCC is activated, the speed limit can only be executed after the driver confirms each change in speed limit.
- When you select Adjust for Speed Limit Assist and turn off Confirm Before Speed Adjustment



and if ACC/LCC is activated, the speed limit can be automatically executed without driver's confirmation for each speed limit change.

Warnings, cautions and limitations

warning

The SAS may not fully function or may provide inaccurate information in the following cases:

- Camera limited .
- Recent changes to roads or speed limits such as construction, controls etc.
- Traffic signs are in poor condition: damaged, faded, blurred or not placed and set as required.

The above warnings, cautions and limitations do not cover all conditions that may affect the normal operation of SAS.

Driver Status Monitoring (DSM)

Instructions for DSM

When the vehicle is running, the DSM will monitor the driver's state. Once the driver shows distraction or fatigue, the system will give a warning.

When the driver experiences fatigue or distraction, the system will provide reminders through instrument panel text and sound. While the driver is fatigued or distracted, the system will increase the sensitivity of LDW and FCW to provide the driver more reaction time.



Opening and closing

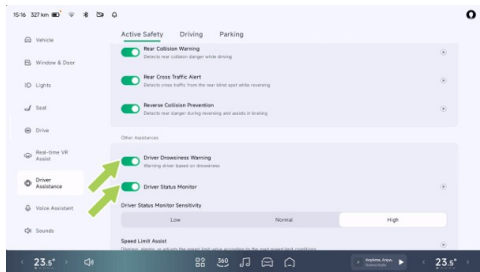

On the “**Driver Assistance**→**Active Safety**” interface of the CID, you can turn on/off the DSM. The DSM provides high, medium and low sensitivity, defaulting to medium at the time of delivery. Users can adjust it according to their driving preferences. The system will remember the user's sensitivity selection.

Driver Drowsiness Warning (DDW)

The DDW is used to monitor the driver drowsiness. When the driver is under drowsiness

condition, the system will give an alarm to remind the driver to concentrate or take other actions to relieve drowsiness and avoid drowsiness driving.

caution

When the DSM/DDW is working, the interior camera will not store or transmit audio and video data involving personal privacy.

warning

- After DSM/DDW is turned off, it will not be able to monitor and remind the driver of drowsiness or distraction, which affects driving safety. Please reconsider before turning it off.
- The DSM/DDW is an auxiliary function. Do not rely on fatigue and distraction reminders to cope with all scenarios. The driver must always keep observing the vehicle control and road environment.
- Please always keep focusing on driving, and do not drive under drowsiness condition. When the system prompts “**Please pay**



attention to road conditions", adjust your driving behavior in time, or park and rest in a service area or safe place as soon as possible.

warning

The DSM/DDW may not work normally in all scenarios, and various factors may cause functional failures, such as:

- The power supply voltage is relatively high or low;
- The hardware circuit is disconnected;
- Interior camera blocked or faulty.

The above warnings, cautions and limitations do not cover all conditions that affect the normal operation of the DSM.



What to Do After a Traffic Accident

Introduction

In the event of one of the following, contact the XPENG Service Center:

- The vehicle has been involved in a crash, immersed in water, or the undercarriage has been scrapped.
- The instrument displays severe fault warning information (such as traction battery failure, traction battery overheating, motor and controller overheating, electric system failure, charging port overheating, etc.) [See 29 page](#).

When the vehicle has a fault or accident, please use the emergency device [See 324 page](#) to alert vehicles behind following the steps below:

1. Park the vehicle in a safe place and turn on the hazard warning light.
2. Remove the safety vest from glove box and put on it.

3. Take out the warning triangle from the trunk, and place it at an appropriate position behind the vehicle.

For your own safety, if your vehicle has been seriously damaged in an accident, pay attention to the following warnings:

- Do not touch the HV harness and all HV components on the vehicle.
- Avoid touching any leaked fluids.
- Never attempt to inspect the vehicle yourself.
- Contact the XPENG Service Center if the vehicle needs to be towed.
- Do not restart the vehicle if it has been immersed in water as doing so may short circuit the battery. For the sake of your own safety and to avoid further damage to your vehicle, immediately contact the XPENG Service Center for inspection so that a professional can assess the damage to the battery system.



- Should you observe smoke coming from the vehicle, immediately move a safe distance away and contact the XPENG Service Center.
- Should your vehicle catch fire, immediately move a safe distance away and call the police and inform the officers that it is an electric vehicle.
- If a battery system fault warning light illuminates on the instrument, pull over safely, move a safe distance away from the vehicle, and contact the XPENG Service Center.
- In the event an occupant in the vehicle is seriously injured, contact your local emergency medical service.
- Scraping or impact to the undercarriage may cause damage to the internal structure of the battery and pose a serious safety risk. Immediately contact the XPENG service center for inspection so that a professional can assess the damage to the battery system.

Safety Guidelines for Using Driver Assistance Systems

Limitations of radar and camera

Tips

Before using the driver assistance function each time, ensure that the radar and camera surfaces are clean and unobstructed .

warning

The following conditions can cause the radar/camera to fail to recognize a target, delay in recognition or identify it incorrectly:

- The radar or camera is blocked or dirty, such as being attached by foreign matters such as ice, snow, frost, rain and fog, accumulated water and dust.
- The radar, camera or related components have a fault.
- Bad weather, such as rain, snow and fog.



- The vehicle jolts and shakes due to uneven roads or other reasons.
- There are sound wave and sound source interferences of the same frequency around the vehicle.
- There are objects near the vehicle that may cause incorrect reflection of sound waves.
- The objects detected by radar are attached with substances that absorb sound waves, such as snowflakes, foam and cotton objects.
- The volume of the detected object is too small.
- In rare special cases, false alarms may be generated for some metal fences, green belts, cement walls, etc.
- Abrupt changes in ambient brightness, such as at tunnel entrances or exits.
- Large shadows cast by buildings, landscapes, or large vehicles.
- The vehicle crashes, and the installation position of the radar or camera is changed.

- Strong light, such as oncoming headlight light or direct sunlight.
- The surrounding environment is dark, such as at night, dawn, dusk and tunnel.

warning

The following targets cannot be identified by the radar/camera:

- Special vehicles, such as those with obstructed rear ends, damaged vehicles, and vehicles with irregular shapes.
- When encountering animals, traffic lights, walls and other unknown obstacles on the road.
- Some metal protective fences, green belts, cement walls, etc.
- Road test facilities, traffic cones, anti-collision barrels, tripods, small construction boards, etc.
- Static obstacles, such as road repair facilities (traffic cones, traffic barrels,



traffic cylinders, warning triangles or other roadblocks) in the middle of the road.

- Static objects, such as low-speed or stationary sweepers, rollover accident vehicles, large stones, tripods, isolation belts, pedestrians crossing the road, etc.

Event Data Recorder (EDR)

Introduction

The vehicle is equipped with an event data recorder (EDR).

The EDR can automatically record the vehicle operation and vehicle safety system status information within a period of time before and after the occurrence of vehicle events, such as:

- Vehicle speed.
- Brake pedal status.
- Longitudinal acceleration.
- Driver's seat belt status.

- Accelerator pedal position, percentage of fully open position.
- Power-up period during the event.
- Power-up period when reading.
- Completeness of event data record.
- Time interval between this event and the previous event.
- Lateral acceleration.
- Yaw rate.
- Steering angle.
- Time of occurrence.
- Gear.
- Brake pedal position.
- Parking system status.
- Airbag deployment time.
- Seat belt pretensioner deployment time.
- Front passenger's seat belt status.
- Occupant protection system alarm status.
- Alarm status of tire pressure monitoring system.



- Brake system alarm status.
- Cruise control system status.
- Anti-lock braking status.
- AEB system status.
- ESC system status.
- Traction control system status.
- Pre-event synchronous timing period.

By collecting and analyzing the vehicle state data recorded by the EDR, it is helpful to understand the relevant situation before and after the event.

The data recorded by the EDR needs to be extracted by connecting special diagnostic equipment to the vehicle OBD port. If necessary, please contact the XPENG Service Center to obtain the equipment.

Declaration of data use

XPENG may use the data recorded by the EDR for fault diagnosis, product R&D and quality improvement. XPENG will not disclose the data

recorded by the EDR to a third party, provided that:

- it is agreed by the owner.
- it is necessary to comply with the requirements of administrative and judicial authorities.
- it is necessary to observe laws and regulations.

Seat belt

Importance of Wearing Seat Belts

Seat belts can be used to restrain the driver and passengers at specified positions to prevent a crash.

In the event of a crash, correctly wearing seat belts can assist other safety systems in absorbing the energy generated by the crash, reduce the inertia of forward motion of the driver and passengers, enable them to get the best protection from the SRS, and minimize injury caused by impact.



warning

In case of an accident, it is very dangerous to rely only on the SRS. Without the protection of seat belts, directly hitting a deploying airbag can cause more serious injuries to the head and chest of the driver/passenger due to the acting force generated by the rapid expansion of the airbag at the moment when the body lunges forward!

warning

Seat belts must be worn correctly. Otherwise, the driver and passengers will lunge forward when an accident occurs, which will not only injure themselves but also endanger other passengers in the vehicle.

warning

It is the driver's responsibility to ensure that all passengers fasten their seat belts correctly. When CID prompts whether to turn off the Rear Seat Belt Unfastened Warning, please turn it off carefully.

Wearing Seat Belts Correctly

Correct driving posture

Whether the driver's sitting posture is correct directly affects the fatigue degree and driving safety of the driver.

To reduce the risk of casualties in accidents, drivers should do the following:

1. Sit upright with both feet on the floor.
2. Make sure your feet can easily step on the pedals. Slightly bend your arms when holding the steering wheel, and keep your chest at least 25 cm away from the center of the steering wheel.
3. The middle section of the seat belt should be placed between the neck and shoulders, and the lap section of the seat belt should be tightly around the hip joint (not the abdomen).

Seat belt pretensioner

In case of a severe frontal crash or side crash, the pretensioner will operate simultaneously



with the airbag. The pretensioner automatically tightens the seat belt, reducing slack in the leg and diagonal parts of the seat belt, thereby reducing the driver's forward tilt.



If the pretensioner and airbag are not activated during a crash, it does not mean that they have a fault. It usually means that the intensity or type of crash is insufficient to activate them.

warning

After an accident, the SRS and other relevant components must be sent for inspection

and replaced if necessary. The seat belt pretensioner must be replaced once it is activated.

Check the seat belt

Each seat belt must be subject to the following four simple inspections in order to confirm that it is operating properly:

1. Check if the seat belt, buckle and other devices are damaged, modified, bleached, stained or seriously dirty.
2. Fasten the seat belt and quickly pull out the seat belt in a position closest to the buckle. At this moment the buckle shall be locked securely.
3. Unfasten the seat belt and retract the seat belt to the maximum extent. Check if the seat belt pulled out is of excessive slackness and check for its worn condition.
4. Partially pull out the seat belt, hold the locking tongue and pull it forward quickly. Then seat belts will be locked automatically



Reassuring travel

by the internal locking mechanism to prevent over-unwinding of seat belts.

If any seat belt fails to pass any of the above tests, immediately contact the XPENG Service Center.

Buckle up the seat belt

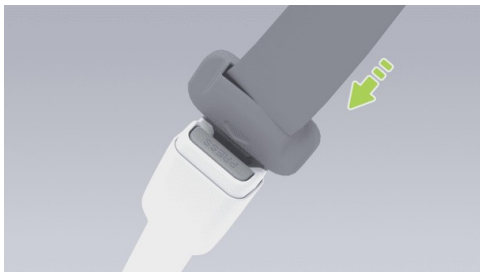

1. Pull out seat belts slowly, make the seat belts evenly go around the entire pelvis, chest and collarbone to keep them between neck and shoulder.

2. Insert the seat belt locking tongue into the seat belt buckles until it “**clicks**” to ensure that the locking tongue is locked in place.
3. Pull out seat belts hard to check if they are fastened.
4. Tighten seat belts toward the spool to tighten any unexpected slack part.

Unbuckle the seat belt

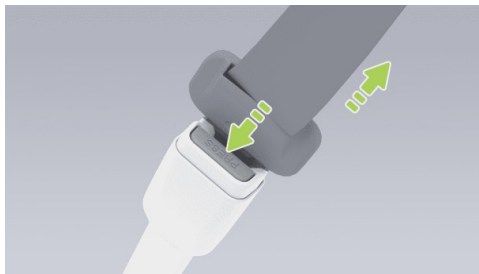

1. Hold the seat belt locking tongue.
2. Press the red unlock button on the seat belt buckle.



3. Continue to hold the seat belt locking tongue and make sure that the seat belt is retracted slowly.

Use of seat belt by expectant mother

Injuries to the expectant mother and her fetus in case of a crash or sudden stop can be effectively reduced by the proper use of seat belts.



The hip/shoulder type seat belt shall be worn correctly by the expectant mother. The shoulder belt shall pass through the chest from a proper

position, and the hip belt shall pass through the crotch as low as possible and fit under the raised abdomen. The seat belt must be flat to not compress the lower body of the expectant mother.

Please consult a physician for better advice.

Use of seat belt by disabled persons

The seat belt shall also be worn correctly by disabled persons.

Please consult a physician for better advice.

Seat belt indicator

1. Indicator for unfastened driver's seat belt
2. Indicator for unfastened front passenger's seat belt
3. Indicator for unfastened second/third row left seat belt
4. Indicator for unfastened third row middle seat belt



5. 指示灯 Indicator for unfastened second/third row right seat belt

If the front passenger does not fasten his/her seat belt, the corresponding seat belt indicator on the instrument will illuminate when the vehicle is stationary. When the vehicle reaches a certain speed while traveling, the corresponding seat belt indicator on the instrument will flash, a warning window will pop up and an alarm sound will be given.

If a passenger in the second or third row does not fasten his/her seat belt, the corresponding seat belt indicator on the instrument will flash.

If all passengers including the driver have fastened their seat belts and the indicator is still flashing, please re-fasten all seat belts to ensure that they are locked correctly.

Clean the seat belt

Pull out the seat belt and wipe it. After cleaning, air dry it before retracting.

caution

Do not use any type of detergent or chemical cleaner to clean the surface of the seat belt.

Replacement of Seat Belt

If there is any sign of wear, cracks or other damages on the seat belt, please contact the XPENG Service Center to replace it. Do not replace the seat belt without authorization.

Warnings, cautions and limitations

- Seat belts must be worn correctly by all passengers including the driver when the vehicle is running. Failure to do so can easily increase the risk of injury or death in case of an accident.
- Never press the seat belt against fragile or sharp objects (such as pens, keys and glasses). The pressure generated by the seat belt on such objects may cause injuries.
- The seat belt must fit the body closely and not be twisted when it is in use. The shoulder



part of seat belt must go around the middle of the passenger's shoulder, and must stick to the upper body of the passenger and be tightened. The seat belt at the waist shall be as low as possible and go across the hips. If necessary, pull down the seat belt slightly. The seat belt can be adjusted by pulling it in the retracting direction.

- Each seat belt is only for use by one passenger or driver in the vehicle. Do not hold a child on his/her lap and share the seat belt with him/her.
- The seat belt shall not be affected by any chemicals, liquids and other substances. If the seat belt can not be retracted or can not be unlocked in the buckle, immediately contact the XPENG Service Center for maintenance.
- Never add unofficial additional items on the seat belt without authorization, including but not limited to the following products: extra locking tongue, strap stopper and buckle extension joint. These items will reduce or even

deactivate the normal protection function of seat belts.

- The seat belt shall be fully retracted without overhanging when not in use. If the seat belt can not be fully retracted, immediately contact the XPENG Service Center for maintenance.
- The seat belts, seat belt retractor and seat belt fixing device shall not be removed, installed, modified or disassembled without authorization.



Airbags

Position of Airbags

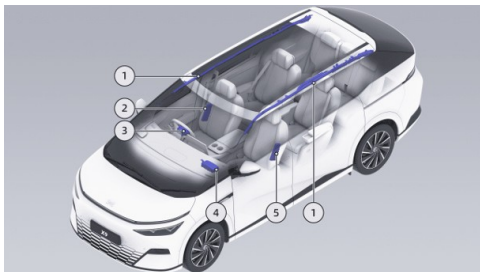

1. Front, middle and rear-through-type side curtain airbag
2. Driver's seat side SRS
3. Driver airbag
4. Front passenger airbag
5. Front passenger's seat side SRS

Conditions and Situations for Deployment

Whether the SRS is deployed does not depend on the vehicle speed when an accident occurs, but depends on the crash strength collected by the crash sensor when an accident occurs. When the impact force of a crash is absorbed or dispersed to the body, SRS may not be deployed. However, depending on different impact conditions during an accident, SRS may also be deployed sometimes. Therefore, whether the SRS is deployed does not depend on the degree of damage to the vehicle.

The SRS may be deployed in the following condition:

- When the vehicle passes over a deep groove, the front end of the vehicle hits the ground.
- The vehicle hits a curbstone or other curb projections.
- The front end of the vehicle hits the ground when the vehicle is going downhill.



The SRS may not be deployed in the following condition:

- The vehicle hits a concrete column, tree or other slender objects.
- The vehicle hits the lower rear of a large truck such as a truck.
- The vehicle encounters a rear-end crash with another vehicle.
- The vehicle rolls over or sideways.
- The vehicle hits a wall or vehicle on the positions other than the front end.

The deployed air bag and seat belt can provide protection for passengers including the drivers to reduce the risk of injury.

Impact after deployment

At the moment of SRS deployment, a loud sound will be heard with the release of gas and powder. Such powder may irritate skin and eyes. At this time, on the premise of ensuring safety, escape from the vehicle as soon as possible. If it is

impossible to do so, open the window or door and inhale fresh air.

If the powder caused by SRS deployment enters eyes or sticks to skin, rinse thoroughly with clean water as soon as possible. In case of serious discomfort, seek medical attention in time.

After the SRS is deployed, its volume will shrink to bring a progressive shock absorption effect to the driver and passengers, to ensure that the driver's front view is not blocked.

Warnings, cautions and limitations

- The SRS can only be triggered once. Contact XPENG Service Center for replacement of the triggered SRS and any affected system components as soon as possible.
- After an accident, even if the SRS is not triggered, the SRS and its related systems may also have a fault. Please contact the XPENG Service Center for maintenance.
- The XPENG Service Center has dedicated tools, OBD device, repair information and



qualified professional technicians. Vehicle repair and modification shall be carried out by the XPENG Service Center.

- Do not use the SRS components removed from scrapped vehicles or recycled SRS components.
- Do not place any object within the SRS inflation range of the driver/front passenger seat, to avoid hindering the SRS inflation in case of frontal crash.
- The front passenger shall not hold children, pets or objects in his/her arms to occupy the SRS inflation space. This is mandatory for both adults and children.
- Do not attach any object (such as portable navigation device) to the front windscreen above the SRS at the front passenger seat.
- Do not cover or paste any object (such as mobile phone bracket and decoration) on the identification surface of steering wheel or front passenger side SRS components, or make any modification to the above parts.
- Do not stack objects on the front passenger seat. In case of emergency stop, once the airbag is deployed, the objects may be ejected and injure the driver and passengers.
- Do not use seat covers. Otherwise, deployment of the front-row side SRS will be restricted in case of an accident and detection accuracy of the system will also be reduced.
- Do not modify the airbag cover or add parts near it. Passengers shall not rest their heads on the doors. Otherwise, when the curtain airbag is deployed, it may cause injury.
- Passengers are not allowed to put their feet, knees or any other body parts above or near the SRS, to avoid obstructing the normal operation of the SRS or causing fracture or other injuries during deployment of the SRS.
- Do not load or place any object above or near the driver/front passenger seat SRS, on the side of the front seat, above the roof at the side of the vehicle, and on any other airbag cover that may interfere with the deployment of the SRS. These articles may cause serious



injuries when the SRS is deployed due to a violent crash.

- Do not try to change the SRS components, circuits and software. Otherwise, the SRS may fail to work normally and provide necessary protection for the driver and passengers, or it may fail to be deployed or deployed accidentally in case of an accident, increasing the risk of injury.

Child passenger

Introduction

To ensure the safety of children, please use proper child safety seats based on their age, weight, and height. Please strictly follow the instructions provided by the child safety seat manufacturer.

Older Child in Vehicle

If children are too big to use child safety seats, but too small to safely use standard seat belts, a child booster cushion that meets relevant

regulations or standards can be purchased and used correctly. The child booster cushion can be used to raise the child, so that the shoulder belt of the seat belt will just cross the middle of the shoulder and lower the seat belt to the crotch.

Adoption of child safety seat

Child safety seat use label



warning

Do not install a backward-facing child seat on a seat protected by SRS; otherwise, death or



serious injury may be caused to the child in the seat.

Front Passenger Airbag Disabling

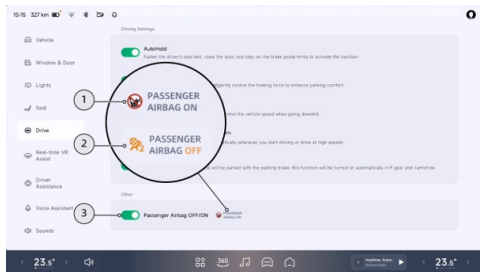

1. Front passenger airbag on
2. Front passenger airbag off
3. Front passenger airbag switch

The front passenger airbag is on by default and can be turned off/on in the following ways:

1. Passenger Airbag OFF/ON can be turned on/off at the “→Drive” interface of central control panel.

warning

- Do not place a rear-facing child seat on the seat with an active frontal airbag. Death or serious injury to the child in the seat can occur.
- Be sure to select an appropriate child safety seat for the child based on his/her age, height and weight.
- One child seat is for only one child. Never constrain multiple children into one child seat with the seat belt.
- Under no circumstances should a child or infant be carried in the occupant's arms during driving.
- Never leave a child unattended in the child seat.
- Never leave children unprotected in a vehicle. Always keep children in the correct

Reassuring travel



seating position during driving. Never stand in the vehicle or kneel on the seat. If an accident occurs under these circumstances, it could be fatal to children and others.

- Any child seat that has been applied forces in an accident must be replaced.



Size category of child safety seat

Size category	Description
A	Full-height forward-facing child restraint system for toddlers
B	Reduced-height forward-facing child restraint system for toddlers
B1	Reduced-height forward-facing child restraint system for toddlers
C	Full-size rear-facing child restraint system for toddlers
D	Reduced-size rear-facing child restraint system for toddlers
E	Rear-facing child restraint system for infants
F	Left-facing child restraint system (portable bed)
G	Right-facing child restraint system (portable bed)

Reassuring travel



Information on the applicability of different seating positions to child restraint systems

Mass group		Front passenger's seat	Second row left seat	Second row right seat	Third row left seat	Third row middle seat	Third row right seat
Group O	10 kg	X	U	U	X	X	U
Group O+	13 kg	X	U	U	X	X	U
Group I	9 - 18 kg	X	U	U	X	X	U
Group II	15 - 25 kg	X	U	U	X	X	U
Group III	22 - 36 kg	X	U	U	X	X	U

Notes:

U: This mass group is suitable for the use of "universal" child restraint systems.

X: not suitable for the child restraint system of this mass group.



Information on the applicability of different ISOFIX positions to ISOFIX child restraint systems

Mass group		Size category	Fixing devices	Front passenger's seat	Second row left seat	Second row right seat	Third row left seat	Third row middle seat	Third row right seat
Carrycot		F	L1	X	X	X	X	X	X
		G	L2	X	X	X	X	X	X
Group O	10 kg	E	R1	X	IL	IL	X	X	IL
Group O+	13 kg	E	R1	X	IL	IL	X	X	IL
		D	R2	X	IL	IL	X	X	IL
		C	R3	X	IL	IL	X	X	IL



Group I	9~18 kg	D	R2	X	IL	IL	X	X	IL
		C	R3	X	IL	IL	X	X	IL
		B	F2	X	IUF	IUF	X	X	IUF
		B1	F2X	X	IUF	IUF	X	X	IUF
		A	F3	X	IUF	IUF	X	X	IUF

Notes:

IL: This is suitable for the use of ISOFIX child restraint systems of "vehicle-specific, limited or semi-universal" category.

IUF: This is suitable for Universal ISOFIX forward-facing child restraint system of this mass group.

X: This seat position does not support the installation of ISOFIX child restraint system.

ISOFIX: International standard for child safety seat anchorages for passenger cars.



Installation of child safety seat

Secure the rearward-facing child safety seat with the seat belt

1. Adjust the second/third row right seat backrest to a reclined position [See 252 page](#). Then place the child safety seat on the seat.



2. Pull out the seat belt, and pass the waist belt through the guide grooves under the armrests on both sides of the safety seat. At the same time, pass the shoulder belt through the blue guide of the seat and the shoulder belt shall bypass the back of the seat.
3. Insert the shoulder belt and the waist belt into the locking tongue together on the other side.

Reassuring travel



Secure the forward-facing child safety seat with the seat belt



1. Place the child safety seat on the second row seat/third row right seat, and then pull out the seat belt completely. The seat belt shall be wrapped and buckled according to the child safety seat manufacturer's instructions.
2. Retract the seat belt, push the child safety seat into the seat firmly and tighten the slack seat belt at the same time.
3. If the child seat has an upper tie-down ring, attach it to the backrest.



Installation of child safety seat through ISOFIX fixing points

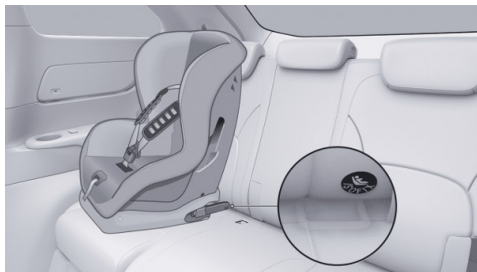

1. Put the child safety seat on the second row seat/third row right seat.
2. Insert the lower fixing bracket of the child safety seat into the ISOFIX anchorage point as per the manufacturer's instructions.

i Tips

- For children ≤ 18 kg and ≤ 3 years old, the second row seat must be adjusted to the rearmost locking position when any type of child safety seat is installed.

Reassuring travel



- Adjust the backrest to the most reclining position before installing and fixing any type of child seat. When the top strap is to be used for fixing, adjust the backrest to a proper position.

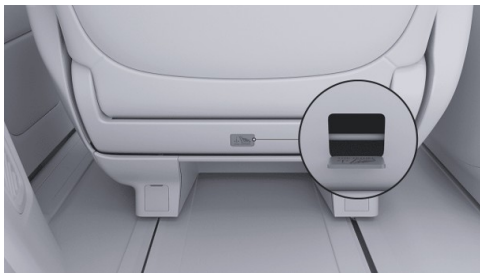

Second row seat: Pass the top fixing belt of the child safety seat through the headrest and pull it to the rear of the backrest. Pry up the anchoring point cover plate with a suitable tool, connect the hook and loop of the fixing belt to the anchoring point, and tighten the fixing belt.

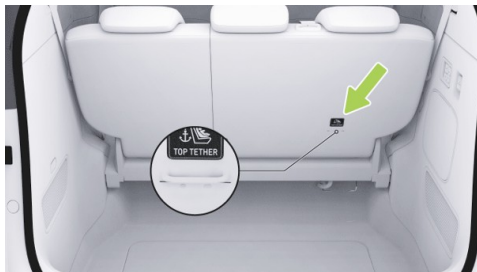

Third row right seat: Pass the top fixing belt of the child safety seat through the headrest and pull it to the rear of the backrest. Connect the hook and loop of the fixing belt to the anchoring point, and tighten the fixing belt.

Check of child safety seat

Make sure that the child safety seat is not loose after installation:

- Fix the child safety seat along the route of the seat belt. Try to slide the child safety seat



from one side to another and from front to back.

2. If the child safety seat can move more than 2.5 cm, the child safety seat is too loose. Then fasten the seat belt or reconnect the ISOFIX child safety seat.
3. If it cannot be fastened, try other seat positions or use another child safety seat.

warning

- Do not install a backward-facing child seat on a seat protected by SRS; otherwise, death or serious injury may be caused to the child in the seat.
- Be sure to select a suitable child safety seat according to the age, height and weight of your child.
- Only children weighing more than 9 kg and able to ride independently can use the forward-facing child safety seat. Children under two years of age have not fully developed their spine and neck, so they shall avoid frontal crash injuries.

- In any case, the driver and passengers shall not hold children or babies in their arms when the vehicle is running. All children shall always be restrained in proper child safety seats.
- Do not leave a child alone in the vehicle even if he/she has been seated in the child safety seat.
- Never allow children to ride without safety protection. When the vehicle is running, make sure that children keep the correct sitting posture and do not stand in the vehicle or kneel on the seat. Otherwise, it may cause fatal injury to children or others in case of an accident.
- Do not use the seat belt extensions on the seat belt intended for the installation of the child safety seats or booster seats.
- When a large child sits in the child safety seat, make sure that there is support for his/her head. The seat belt shall be properly adjusted and fixed. The shoulder part seat belt must be kept away from the child's



face and neck, and overlapped parts of the seat belt must also be kept away from your abdomen.

- Only one child can be seated in one child safety seat. The seat belt shall not be used to restrain multiple children on one child safety seat.
- Never fasten two child safety seats to one anchorage point. In case of a crash, one anchorage point may not be sufficient to secure two child safety seats.
- The anchorage point of the child safety seat only bears the load from a correctly installed child safety seat. Under no circumstances can the child safety seat be used to install adult seat belts, harnesses or other objects or equipment.
- Make a final inspection of the safety harnesses and lacing for damage and wear.
- Never use a child safety seat that has been modified, damaged or involved in an accident. Please check or replace the child

safety seat according to the manufacturer's instructions.

- To ensure the safety of children, be sure to follow all instructions detailed in this manual and those provided by the child seat manufacturer.

Baby-on-Board mode

Baby-on-Board Mode can be activated in the following ways:

- CID
 - Shortcut panel (only supports child safety lock on/off)
 - Setting interface
 - Bottom taskbar (if set) [See 24 page](#)
- X-Peng voice

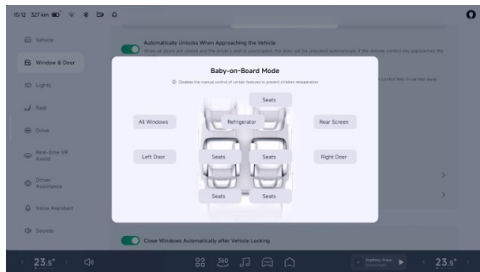

- On the “**Window & Door**→**Baby-in-Car Mode**” interface of the CID, you can enable the “**child lock**” mode for components such as windows, seats, refrigerators, rear screens and child safety locks.
- Child safety locks are installed on both rear doors of the vehicle. After the child safety lock is activated in Baby-on-Board Mode, the corresponding door cannot be opened through the electric release switch, which can prevent children from opening the rear door by mistake. The window lock can also be enabled to lock the passenger windows

glass lifter and reduce the accident risk during riding. The seat, refrigerator and rear screen can also be locked by disabling the manual control of certain features to avoid children misoperation.

Tips

It is recommended to activate the child safety lock when a child sits on the second row seat.

warning

- When the child safety lock is activated, corresponding door cannot be opened from inside. Please do not leave a child alone in the vehicle.
- When there is a child in the vehicle, to ensure safety, the passenger window shall be locked to prevent the child from operating the window and avoid pinching.



Alcolock

Introduction

The vehicle is equipped with an communication Alcolock, which can be installed with a LIN communication Alcolock (the port must meet the 50436-4 2-22 version specification).

Forward/backward radar warning

Introduction

When the vehicle is parked or running at a low speed, the ultrasonic radar can detect the distance between the vehicle and the surrounding obstacles and give a warning through the SR interface and prompt sound.

caution

- When a red bar is displayed, it means that the obstacle is very close to current vehicle and special attention should be paid.

- The frequency of the alert sound will gradually increase as the distance between current vehicle and the obstacle decreases.

Tips

- When the vehicle is in D gear and the speed is less than 12 km/h, the radar will give early warning; when the vehicle is in R gear, there is no speed limit for radar warning.
- Even if the obstacle is soft (such as tall and thin weeds) and will not damage the vehicle, the radar warning will still issue a warning.

Warnings, cautions and limitations

warning

The radar warning may not work normally in the following scenarios:

- Radar limited .
- The vehicle approaches the obstacle at a high speed.



The above warnings, cautions and limitations do not cover all situations that affect the normal operation of radar warning.

Braking assist

Introduction

Electronic Stability Program (ESP)

ESP uses sensors to identify vehicle driving states (e.g., understeer, oversteer, or drive wheel slippage), and can apply targeted braking intervention or limit drive torque to effectively reduce the risk of sideshow or tailspin to ensure vehicle driving stability.

Opening and closing

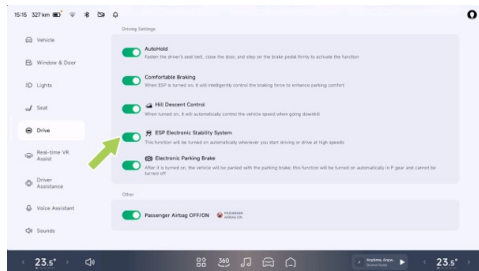

On the “**Drive**” interface of the CID, you can enable/disable “**ESP Electronic Stability System**”.

i Tips

- When the vehicle is powered on, the ESP will be activated automatically.
- When the vehicle speed is greater than 80 km/h, if the ESP is off, the ESP function will be activated automatically.



- When the steering mode is switched, if the ESP is turned off, the ESP function will be activated automatically.

warning

- The ESP cannot prevent accidents caused by dangerous driving or emergency steering at a high speed.
- In case of an ESP fault, please contact the XPENG Service Center for maintenance immediately.

Anti-lock Braking System (ABS)

Wheel locking can be prevented by ABS when the driver depresses the brake pedal deeply to avoid loss of steering ability or drifting.

Distributed Traction Control System (dTCS)

When the vehicle starts or accelerates rapidly on a slippery road surface such as ice and snow, the driving wheels will slip. dTCS controls brake pressure and vehicle torque output to minimize wheel slip.

Electronic Brakeforce Distribution System (EBD)

The EBD is a part of the ABS. When the vehicle brakes normally, the EBD can balance the distribution of braking force between the front and rear wheels according to the vehicle load.

The EBD can properly distribute the brake force generated by the brake system to four wheels based on the traction between the wheels and the road surface. This ensures maximum braking efficiency, significantly shortens the braking distance, keeps the vehicle stable during braking, and improves driving safety.

Brake Assist System (EBA)

In case of emergency, quickly depress and hold the brake pedal. The EBA will generate a braking pressure greater than that during normal braking, so that the braking system can produce the pressure required for maximum deceleration in the shortest time, thus obtaining the shortest braking distance.



Hill Descent Control (HDC)

The HDC is a cruise control function, which can help the driver drive downhill at a constant speed and relieve foot fatigue caused by depressing the brake pedal all the time when driving downhill.

Opening and closing

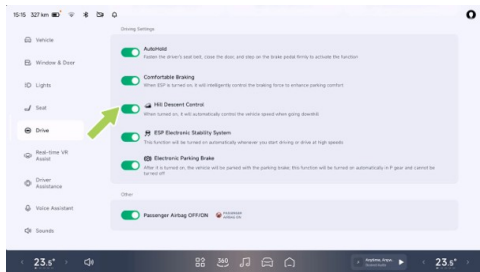

On the “**Drive**” interface of the CID, you can enable/disable “**Hill Descent Control**”.

The HDC function is available when the vehicle speed exceeds 8 km/h but does not exceed 35

km/h. If you press the brake pedal or accelerator pedal during HDC operation, the HDC function will exit, and the driver needs to take control of the vehicle. When the vehicle speed exceeds 60 km/h, the HDC function will exit completely.

i Tips

- The HDC can work on slopes with a gradient of 5% or more.
- Conditions for starting the HDC: The vehicle speed is less than 35 km/h, the brake disc temperature is normal, and the ESP system is normal.

! warning

The HDC can actively keep the vehicle descending at a constant speed, but it cannot go beyond the kinematics law. For safety reasons, the driver shall apply brake in time according to the actual situation of the vehicle, to avoid accidents caused by too fast downhill speed of the vehicle.



Hill Hold Control (HHC)

When the vehicle stops and starts on a hill with a slope of more than 5%, during the period when the driver releases the brake pedal to depress the accelerator pedal, the power output is not enough to start the vehicle. Before moving forward (the vehicle tends to slide), the HHC will maintain the braking force required by the driver to stop the vehicle and keep the vehicle in a static state, to prevent the vehicle from sliding.

i Tips

- The HHC is only applicable to the following conditions: When the gearshift lever is in D or R position, the brake pedal is depressed and the braking force generated before releasing the brake pedal is sufficient to keep the vehicle on a hill.
- The HHC can last for about 1 second, and the brake pressure holding time will be released in advance or extended appropriately (not more than 2 seconds)

according to factors such as driver and ramp.

! warning

The HHC can provide braking assist, but it cannot go beyond the kinematics law. For safety reasons, the driver should apply brake in time according to the actual situation of the vehicle to avoid accidents caused by slope slipping.

Tire Pressure Monitoring System (TPMS)

Introduction

The TPMS can monitor the tire pressure and temperature in real time when the vehicle is running, and give an alarm in case of abnormal tire pressure, tire temperature or TPMS system, to ensure driving safety.



! warning

- When the tire pressure or TPMS is abnormal, the  will light up on the instruction panel and the corresponding text reminder will pop up: **“The tire pressure is relatively low. Please replenish air in time”**; **“The tire pressure is too low, please replenish air immediately”**; **“TPMS fault, please contact for repair”**. Please handle it strictly according to the text reminder.
- Do not modify the tire pressure monitoring system without permission.

Operation

The tire pressure will be automatically calibrated after each tire replacement. Before calibration, please keep the vehicle stationary for more than 17 minutes. During calibration, please drive at a speed of more than 37 km/h for 10 minutes and avoid reversing.

Low-speed Simulation Sound (AVAS)

Introduction

When the vehicle is moving at a speed of less than 30 km/h, an analog sound will be emitted to alert nearby pedestrians and vehicles.

Operation

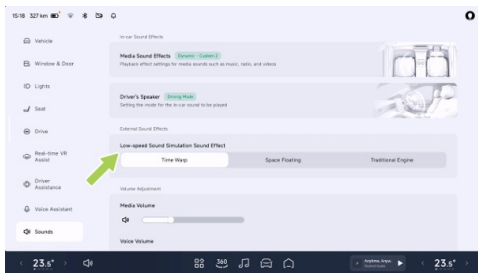

On the “→**Sounds**” interface of the CID, you can select **“Low-speed Sound Simulation Sound Effect”**.



Locking and unlocking

Introduction

When the vehicle is unlocked, doors will be unlocked, exterior rearview mirrors will be deployed, the anti-theft alarm system will be deactivated, and the front door handle (if set) is popped up synchronously.

When the vehicle is locked, the doors will be locked, exterior rearview mirrors will be folded, windows closed and anti-theft alarm system will be activated, and the front door handle is retracted synchronously.

The vehicle can be unlocked/locked by the following ways:

- Auto Unlock or Lock [See 162 page](#)
- Smart remote key [See 164 page](#)
- Mobile App Bluetooth key [See 168 page](#)

i Tips

- The vehicle can be locked only when the vehicle is stationary, the doors (including trunk) and front hood are closed, the vehicle is in P gear and there is no person on the driver's seat.
- After the vehicle is unlocked, if any door (including the trunk) is not opened within 2 minutes, the vehicle will be locked again.

When the vehicle is unlocked, the doors can be closed/unlocked by the following ways:

- Vehicle door lock switch on interior trim panel of driver's seat door
- Vehicle door lock switch of CID

When the doors are locked, the doors/trunk cannot be opened by using the exterior door handle/exterior trunk switch, and the Charging port cover cannot be pressed to open.



i Tips

- When certain conditions are met, the doors will be unlocked/locked automatically.
- Carrying the key, doors/trunk/charging port cover can be opened from outside even if the vehicle is locked.

Operation

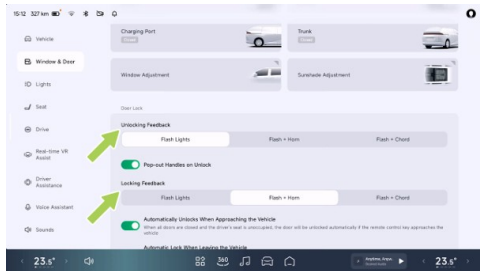

Setting of vehicle unlocking/locking feedback mode



When the vehicle is successfully unlocked, the turn signal will flash 2 times; when the vehicle is successfully locked, the turn signal lamp will flash 1 time. On the “**Window & Door**” interface of the CID, you can set whether to play the horn or chord effect synchronously.

Turn on/off vehicle door lock



- Using vehicle door lock switch: Press  to unlock doors and press  to lock doors.

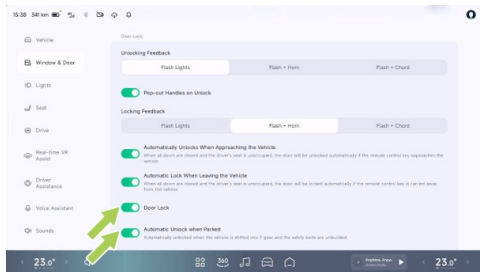

- Open vehicle door lock interface of the CID by any of the following ways:
 - “**Window & Door**” interface of the CID, you can turn on/off “**Door Lock**”.
 - Tap “**Door Lock**” at the bottom taskbar of the CID (if set [See 24 page](#)), to lock/unlock the vehicle.

- Tap “**☰**” on the CID, then tap “**All-domain Intelligent Driving**” in the App Center or tap “**All-domain Intelligent Driving**” at the bottom taskbar of the CID (if set [See 24 page](#)). Enter the Intelligent Driving interface, and tap the icon below the 3D car model to unlock/lock the vehicle.
- Vehicle door lock can be locked/unlocked automatically when certain conditions are met:
 - Automatic locking during driving: When the doors (including trunk) and front hood are closed, if the vehicle speed is greater than



10 km/h, the door lock will be locked automatically.

- Automatic unlocking of parking: When the vehicle is shifted to P gear and (driver's seat) the seat belt is released, the door lock will be automatically unlocked.

i Tips

On the “🚗→Window & Door” interface of the CID, you can turn on/off “**Automatic Unlock when Parked**” .

- Automatic Unlock when Door Opened: Open the door from inside the vehicle (release the door opening button/Slide door switch/emergency opening for front row power supply), and then the vehicle door lock will be automatically unlocked.
- Automatic Unlock in Emergency: Vehicle door lock will be automatically unlocked when the vehicle crash or thermal runaway and other emergencies occur.

Anti-theft Alarm System

When the anti-theft system is activated and any door (including trunk) or front hood is opened, the anti-theft system will give an alarm through the horn and turn signal. The alarm of the anti-theft system can be deactivated after unlocking the vehicle.

i Tips

The alarm of the anti-theft system lasts for about 28 seconds. If any door (including trunk) or front hood is opened again, it will be re-timed.

⚠ warning

Do not modify the vehicle's anti-theft system; otherwise, the system may not work normally.



Keyless entry

Introduction

The remote key or phone key can be used to realize the functions of Automatic Unlock When Approaching the Vehicle and Automatic Lock When Leaving the Vehicle.

Tips

After the vehicle is locked automatically, if it is still within the functional sensing range, the vehicle may not be unlocked by sensing when approaching the vehicle again. At this time, pull the door handle or use the key to manually unlock.

caution

When the vehicle is stationary, the doors (including the trunk) and front hood are closed, the vehicle is in P gear, and the driver's seat is unoccupied, the vehicle can be automatically locked only when its key is far

away from the vehicle. Please make sure that the vehicle is locked before leaving.

Operation

Auto Unlock or Lock by remote key

With the remote key carried, the following functions can be realized:

- The vehicle will be unlocked automatically when the key gets close to the position about 3.5 meters from the vehicle, and will be locked automatically when the key gets far away from the position about 8 meters from the vehicle.

Tips

On the “Window & Door” interface of the CID, you can enable/disable “**Automatic Unlock When Approaching the Vehicle**” and “**Automatic Lock When Leaving the Vehicle**”.

- Pull the front door exterior handle or press the switch on Slide door exterior handle to unlock the vehicle.



- Press the upper left area of the charging port cap to open the charging port cap.
- Press the trunk exterior switch to open the trunk.

Auto Unlock or Lock by phone key

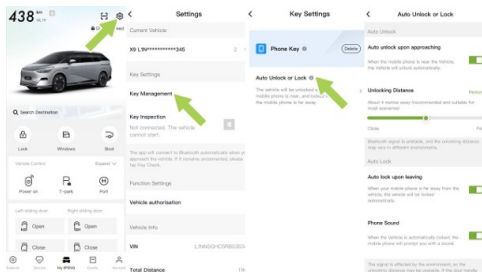

After activating the phone key [See 168 page](#), on the “**My XPENG**→**Key Management**→**Auto Unlock or Lock**” interface of your mobile app, you can set the keyless entry function for your phone key.

! caution

- Auto Unlock or Lock needs to be reset for re-activating the phone key, reinstalling the mobile APP and logging in with another phone.
- Do not exit the mobile APP after unlocking, and keep the mobile APP running in the background; otherwise, it may be impossible to lock the vehicle.

Warnings, cautions and limitations

Passengers with implanted cardiac pacemakers shall keep a distance of at least 22 centimeters from the vehicle's Bluetooth antenna to avoid the Bluetooth antenna interfering with the function of the cardiac pacemaker.



Bluetooth antenna position

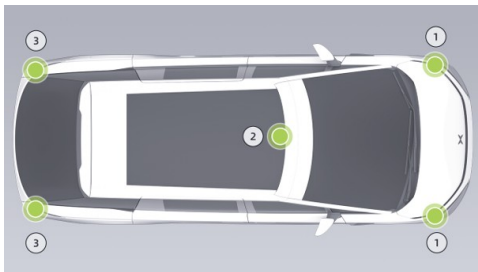

1. Both sides of front bumper
2. Behind the front reading lamp
3. Both sides of rear bumper

Smart remote key

Introduction

The vehicle is equipped with a UWB smart remote key, supporting both button operation and Auto Unlock or Lock [See 162 page](#)

Operation

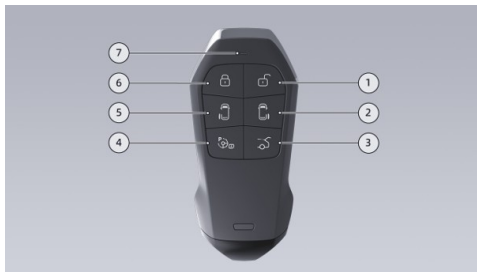

1. Unlock button
 - Short press this button to unlock the vehicle.
2. Right Slide door open/close button
 - Double-tap this button to open/close the right Slide door and pause the opening/closing of the right Slide door.
3. Trunk open/close button



- Double-tap this button to open/close the trunk, and pause the opening/closing of the trunk.
4. Charging port open/close
- Double-tap this button to open/close the charging port cover.
- *The parking function interface is reserved on the smart remote key and will be launched later according to market conditions. The launch time is to be determined.
5. Left Slide door open/close button
- Double-tap this button to open/close the left Slide door and pause the opening/closing of the left Slide door.
6. Lock button
- Short press this button to lock the vehicle.
7. Indicator
- Press any button. If the key is successfully connected to the vehicle, the indicator

will flash 1 time; if the connection is unsuccessful, the indicator will flash 2 times.

i Tips

- The trunk/charging port cover/Slide door can only be opened with the remote key when the vehicle is in the P gear position.
- In an open field, the effective range of the remote key is more than 30 meters. Insufficient power will affect the remote control distance. At this time, try to approach the vehicle or use other methods to operate.

Entry and exit



Replacement of smart remote key battery



1. Press the unlock button and remove the trim cover.



2. Use a suitable tool (slotted screwdriver covered with soft cloth/wrapped with adhesive tape or similar tools) to pry up the left edge and move it towards the center to pry loose the left side of the rear cover.



Entry and exit



3. Pry up the right edge and move to the middle to pry loose the right side of the rear cover.

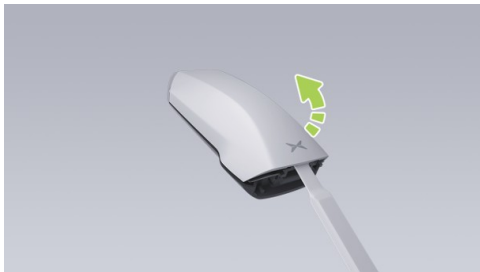

4. Pry up the middle part of the rear cover and remove it.



5. Replace the battery. Battery model: CR2450. Make sure that the "+" (positive pole) of the battery faces upward during installation.
6. Clamp the trim cover plate and the trim cover.



Mobile App Bluetooth key

Introduction

The phone key supports remote check of vehicle status, remote vehicle control, Auto Unlock or Lock See 162 page, and other functions.

Operation

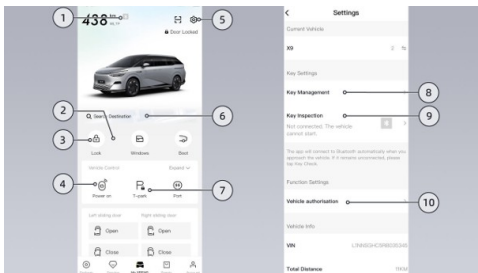

1. Bluetooth state: When the phone key is connected to the vehicle Bluetooth, it is blue; when not connected, it is gray.

i Tips

- When the phone key is connected to the vehicle Bluetooth, it can also be used in environments without network signals such as garage.
 - The vehicle is equipped with both media Bluetooth and key Bluetooth. The phone key will automatically connect to Bluetooth without pairing in the CID.
 - Usually, the Bluetooth connection range in an open field is about 20 meters, which may be different due to factors such as mobile phone Bluetooth hardware, environment occlusion and interference.
2. Shortcut bar: Long press this area to customize the functions of the shortcut bar, with a maximum of 8 functions.
 3. Vehicle lock
 - When the phone key is not activated: tap “**Activate key**” to activate the phone



key. After successful activation, the original **“Activate key”** changes to **“Vehicle lock”**.

- When Bluetooth is not connected: Tap to select **“Unlock only”** or **“Unlock and start”**.
- When Bluetooth is connected: tap **“Unlock vehicle”**, and then engage a gear within 20 minutes to start the vehicle.

i Tips

- Do not exit the mobile APP after unlocking, and keep the mobile APP running in the background; otherwise, it may be impossible to engage a gear.
- If the gear cannot be engaged, try to re-open the mobile APP.

4. Remote start: Tap to unlock the door, press brake pedal within 2 minutes to engage a gear and then the vehicle can be started for others to drive temporarily.
5. Setting: Tap to enter the setting interface.
6. Vehicle location/map

- Only the owner account can view the real-time location of the vehicle.
 - Tap to enter the map, and after setting the destination, it can be quickly sent to the CID for seamless navigation [See 41 page](#).
7. Temporary stop: Tap it to lock the vehicle, and the CID, infotainment screen and A/C can be still available within one hour.
 8. Key management: After activating the phone key, you can set Auto Unlock or Lock [See 162 page](#).
 9. Key check: When you bring the phone key close to the vehicle, Bluetooth will be automatically connected. If it has not been connected or the vehicle cannot be started by engaging a gear, tap **“Check key”** and solve the problem through the guidance.
 10. Vehicle authorization: Authorize the vehicle to other XPENG accounts, and a maximum of 5 accounts can be authorized.



caution

The vehicle authorization needs to be connected to the Internet and there may be delayed feedback. In case of any problem, please try again. In order to respond faster to unlocking and locking, please enable the following permissions for XPENG Automobile APP in system permission settings:

- Non-iOS system: Bluetooth permission, self-starting permission and background running permission.
- iOS system: Location information-always allowed; background App refresh; location service (mobile phone settings → privacy → location service).

Welcome mode

Introduction

When you approach the vehicle or get off the vehicle with the key, the lamps, seats and

suspension will welcome guests to facilitate getting on and off.

Tips

Please wait for the end of seat welcoming before getting on or off.

Operation

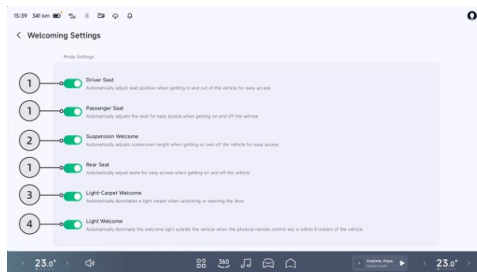

On the “→**Window & Door**→**Welcoming Settings**” interface of the CID, you can set various welcoming functions.



1. Seat welcome

- Driver/front passenger welcome: When it is turned on, the seat can be automatically adjusted to facilitate entry and exit. After the door is closed, the seat will return to its memory position.
- Rear row guest welcome: After it is turned on, when the vehicle is powered up and the Slide door is opened for the first time, the second row seats will be automatically adjusted to a position convenient for passengers in the second row to get on or off.

i Tips

- If the driver/front passenger backrest angle is large, seat moving backward may affect passengers in second row. In this case, the welcoming function will not be activated.
- If the driver/front passenger seats are relatively backward and it is convenient for the driver and passengers to get

off, the welcoming function will not be activated at this time.

- If the positions of second row seats are farther back than those after guest welcoming and passengers can easily get on, the second row seat guest welcoming function will not be activated.

- ### 2. Suspension welcome: When it is turned on, the vehicle is shifted to P gear position and the seat belt is released, the suspension will be lowered to the welcoming height to facilitate getting off; after welcoming, when the driver's seat belt is fastened and the driving gear is engaged, the suspension will return to the traveling height.

⚠ caution

When the suspension welcome function is turned on, pay attention to the surrounding environment of the vehicle when getting on and off the vehicle to avoid bumping because the suspension will descend.



3. Light carpet welcome: After it is turned on, unlocking or opening the left Slide door will automatically light up the light carpet to increase the sense of ceremony.
4. Light welcome: After it is turned on, the position lights, headlights and light carpet of vehicles will be automatically lit to increase the sense of ceremony when you are approaching.

Hidden electric door handles

Introduction

When the door is unlocked, it can be opened by the concealed door handle.

Operation

Manual unfolding



When the vehicle is unlocked, press the front end of the door handle and pull it out to open the door.



Automatic unfolding

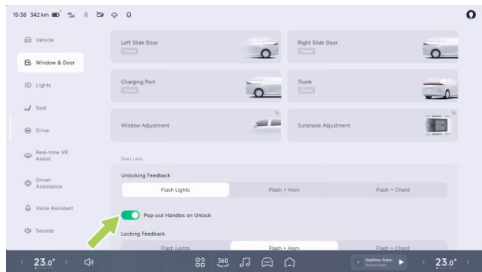

On the W“Window & Door” interface of the CID, after you turn on “Pop-out Handles on Unlock”, and when the vehicle is unlocked, the front door handle will automatically pop out. Pull the handle to open the door.

Automatic retraction

- Locking retraction: When the door is locked, the front door handle will be automatically retracted.

- Retraction when changing gear: When the gearshift lever is switched from P to N/R/D, the front door handle will be automatically retracted.
- Overspeed retraction: When the vehicle speed exceeds 3 km/h, the front door handle will be automatically retracted.
- Timeout retraction: After the doors (including trunk) and front hood are closed, if the above-mentioned retraction operation is not performed within 120 seconds, the front door handle will be automatically retracted.

Opening/closing of electric doors

Introduction

The electric door can be opened/closed by the following ways:

- Hidden electric door handle [See 172 page](#)
- Front row electric door release button
- Emergency opening handle
- Mechanical key



Operation

Front row electric door release button

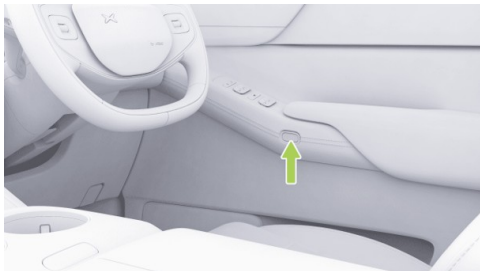

When the vehicle is stationary, press the electric door release button to open the door.

i Tips

When the vehicle speed is greater than 3 km/h, it is impossible to open the door by pressing the electric door release button.

Emergency opening handle

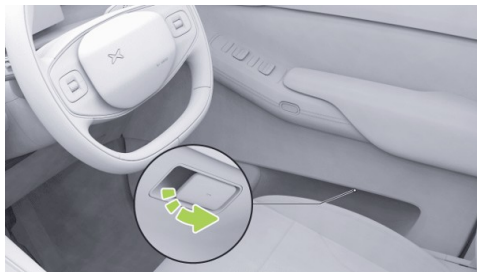

Pull the emergency opening handle under the front door armrest to open the door.

⚠ warning

Whether the vehicle is stationary or moving, the door can be opened by pulling the emergency opening handle once. Do not pull the emergency opening handle during driving in non-emergency situations.



Mechanical key



When the vehicle is out of power, press the front end of the concealed door handle and pull it out. Insert the mechanical key into the lock hole, rotate counterclockwise to unlock the door, and then pull the door handle to open the door.

i Tips

- Insert the mechanical key and turn it clockwise to lock the driver's seat door.
- Only the driver's seat door can be opened with a mechanical key. After entering the

vehicle, other doors can be opened by using the emergency opening handle/pull ring.

Opening/closing of intelligent anti-pinch slide doors

Introduction

The Slide doors can be opened/closed by:

- Exterior Slide door switch
- Internal Slide door switch
- Smart remote key [See 164 page](#)
- Mobile App Bluetooth key [See 168 page](#)
- X-Peng voice
- CID
 - 3D Vehicle Control [See 55 page](#)
 - Setting interface
 - Bottom taskbar (if set [See 24 page](#))
 - Shortcut panel [See 25 page](#)
- Emergency opening pull ring



- Emergency locking switch

i Tips

- When the charging port cover opens, the right Slide door cannot be opened electrically.
- The Slide door has the anti-pinch function. When an obstacle is detected during closing, Slide door will retreat for a certain distance.
- If the anti-pinch or push-to-open/close function fails, initialization of the Slide door can be performed.

⚠ warning

- Please confirm that the Slide door is completely closed before driving.
- When closing the Slide door, please do not put your hand on the edge of the door to prevent pinching.
- When closing the Slide door, make sure that there are no personnel or other obstacles

within the closing range of the door to prevent personal injury or vehicle damage.

Operation

Exterior Slide door switch



When the door is unlocked, press the exterior Slide door switch to open/close the Slide door. Press it again during sliding to pause opening/closing.



i Tips

When the vehicle is unlocked, press the exterior Slide door switch to unlock the door and then the Slide door will open.

Internal Slide door switch



When the door is unlocked, press the interior Slide door switch to open/close the Slide door.

Press it again during sliding to pause opening/closing.

! warning

- Please operate when the vehicle is stationary, and avoid opening/closing the Slide door after the vehicle starts.
- When the window is lowered, do not put your head and hands out of the window when opening the corresponding sliding door.
- Do not open/close the Slide door on a ramp.

i Tips

- If the vehicle speed is greater than 3 km/h and the Slide door is not closed, the SR interface and prompt sound will remind users of such failure.
- When the vehicle speed exceeds 3 km/h, the Slide door can only be closed and cannot be opened.

Entry and exit



- The corresponding Slide door cannot be opened when the electronic childproof lock is engaged .
- The Slide door has anti-pinch function. When the window opening is greater than or equal to 20% and open the corresponding Slide door, the Slide door will slide to a limited position and stop. The Slide door can only be opened again by using a switch.
- If the charging port cover is opened while the right Slide door is opening, the Slide door will slide to and stop at a limited position.

CID setting interface

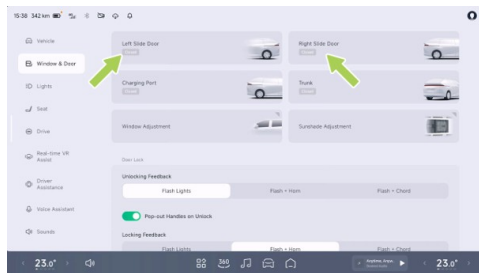

When the vehicle speed is less than 3 km/h, on the “**Window & Door**” interface of the CID, you can open/close the “**Left/Right Slide Door**”. During sliding, tap again to pause opening/closing.



Concealed door handle



When the door is unlocked, the Slide door can also be opened manually by sliding the Slide door backward with the concealed handle of the outward-opening Slide door.

Emergency opening pull ring



1. Press to open the cover plate under the Slide door.
2. Pull the emergency opening pull ring of the Slide door and slide the Slide door backward to open it in emergency.

i Tips

When the Slide door is closed, it is locked.



Emergency locking switch



If the Slide door cannot be locked under special circumstances, pry up the side locking panel of the Slide door with a suitable tool, press the internal switch to slide close the Slide door and then the Slide door is locked.

Slide door initialization

Pull the Slide door exterior handle to slide and close the Slide door, and then the Slide door initialization is completed.

Opening/closing of the trunk

Introduction

The trunk can be opened/closed by the following ways:

- Trunk exterior switch
- Trunk bottom switch
- Smart remote key [See 164 page](#)
- Mobile App Bluetooth key [See 168 page](#)
- X-Peng voice
- Steering wheel shortcut buttons (if set) [See 234 page](#)
- CID
 - 3D Vehicle Control [See 55 page](#)
 - Shortcut panel [See 25 page](#)
 - Bottom status bar (if set) [See 24 page](#)
 - Setting interface
- Emergency opening switch



i Tips

When opening/closing the trunk, if there is an obstacle, the trunk will retreat for a certain distance.

⚠ warning

When opening/closing the trunk, make sure that there are no personnel or other obstacles within the opening/closing range of the trunk to prevent personal injury or vehicle damage.

Operation

Trunk exterior switch

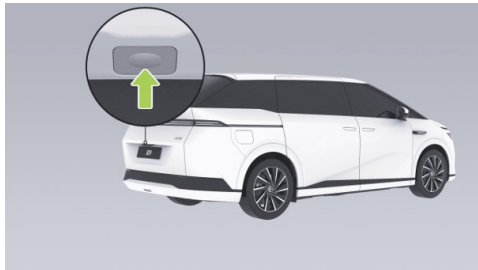

With the doors unlocked, press the trunk exterior switch to open/close the trunk.



Trunk bottom switch



- Press the trunk bottom switch to open/close the trunk, or pause the opening/closing of the trunk.
- Press the trunk with a certain force in the closing direction to close the trunk.

Adjustment of Trunk Deployment Angle

- When the trunk is deployed to a desired angle, press and hold the trunk bottom switch until there is the sound feedback. At this point,

the setting of the trunk deployment angle is completed.

i Tips

If the trunk deployment angle is lower than the minimum allowable setting when the switch is pressed and held, the trunk deployment angle will be set to the minimum value.

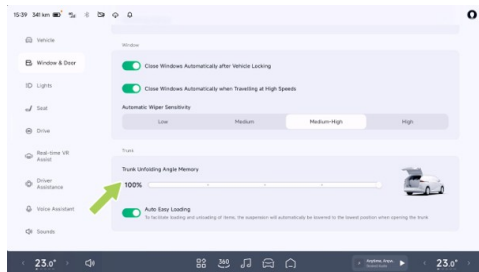

- On the “**Window & Door**” interface of the CID, you can adjust “**Trunk Unfolding Angle Memory**”.



CID setting interface

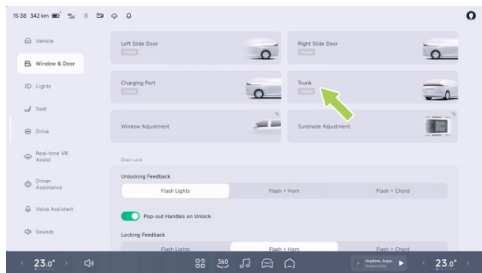

On the “Window & Door” interface of the CID, you can open/close the “**Trunk**”. Tap again during movement will pause opening/closing.

i Tips

After “**Auto Easy Loading**” is turned on, when the trunk is opened, the suspension will automatically descend to facilitate loading and unloading.

Emergency opening switch

If the trunk cannot be opened, it can be opened by the following operations:

1. Put down the third row backrest and get into the trunk.



2. Open the trim cover on the emergency unlocking device.

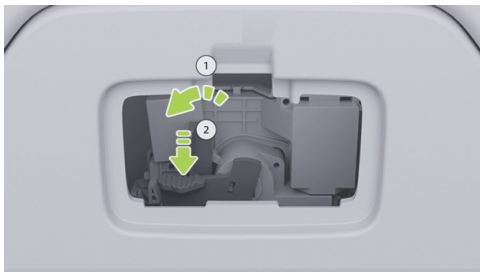

3. Pull the lever ① to the left and hold it, then press the lever ② to unlock the trunk, and then push the trunk outwards to open it in emergency.

i Tips

After emergency opening, press down the trunk to close it.

Power on and off

Introduction

The vehicle can be powered on/off by the following ways:

- Open the door to power on.
- Engage a gear to start.
- Lock the vehicle to power off.
- Remote startup.
- Emergency power-off.
- Depress the brake pedal to power on.

In addition, the vehicle will be powered on/off automatically when certain conditions are met.

- If the driver's seat is unoccupied, the vehicle is parked and all doors (including the trunk) and front hood are closed, after 1 hour of inactivity, the vehicle will be automatically powered off.



i Tips

On the “☰→**General**→**Safety and Privacy**” interface of the CID, you can enable/disable “**Power Off Automatically**”. A pop-up window to show a message of a 10-minute countdown to automatic powering off will display on the CID. Tap “**Cancel**” to reset the 1-hour countdown.

- Power on the system for upgrade.
- Power on upon the request of the automated driving function.

Operation

Open the door to power on.

Power on, if any door (excluding the trunk) opens when the vehicle is unlocked.

Engage a gear to start.

Shift to D/R gear, and the vehicle becomes “**READY**”.

Lock the vehicle to power off.

When the vehicle is locked, the vehicle is powered off.

Emergency power-off



The following ways can be used for emergency power-off:

- When the vehicle is stationary, press and hold the emergency power-off switch for 5 seconds to directly power off the vehicle.

Entry and exit



- When the vehicle is stationary or at a certain speed, press the emergency power-off switch continuously for 3 times within 2s to directly power off the vehicle.

i Tips

When the vehicle is at a certain speed, long pressing the emergency power-off switch needs to be confirmed on the instrument. Pressing it 3 times within 2 seconds will directly power off regardless of whether the vehicle is at a certain speed or not.

Depress the brake pedal to power on.

When the vehicle is powered off, if the remote key or phone key is placed in the vehicle, press brake pedal to power up the vehicle.



Infotainment screen

Introduction

The infotainment screen can be controlled in the following ways:

- In-vehicle infotainment remote control [See 189 page](#)
- Second row infotainment screen switch
 - Shortcut panel [See 25 page](#)
 - Bottom status bar (if set) [See 24 page](#)
 - Setting interface
- Infotainment screen shortcut panel [See 26 page](#)
- X-Peng voice

Operation

Second row infotainment screen switch



Press the switch to unfold/fold the infotainment screen.



CID setting interface

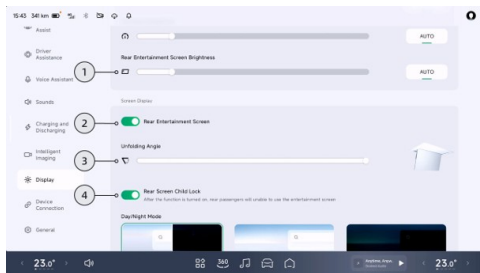

On the “→Display” interface of the CID, you can set the infotainment screen.

1. “**Rear Infotainment Screen Brightness**” can be adjusted or “**AUTO**” mode can be selected.
2. “**Rear Infotainment Screen**” can be unfolded/ folded.
3. “**Unfolding Angle**” of the infotainment screen can be adjusted.

4. When “**Rear Screen Child Lock**” is turned on, the rear voice or remote control cannot turn on the infotainment screen.

Connecting Bluetooth Headphone

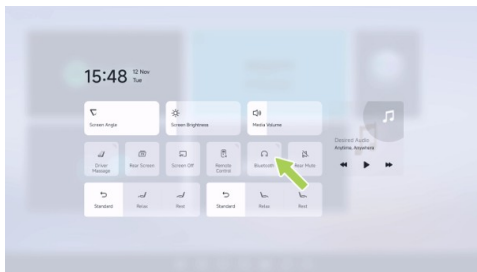

On the infotainment screen shortcut panel See [26 page](#), tap “**Bluetooth**”. You can connect Bluetooth headphones as prompted. Once the headphones are successfully connected, the sound playing in the rear row will be output through the Bluetooth headphones.



In-vehicle infotainment remote control

Introduction

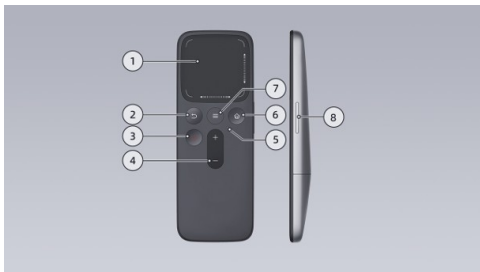

1. Touchpad

- Tap: Press the touchpad to confirm screen operation.
- Slide: Slide on the touchpad to control the cursor on the screen.
- Edge slide: Slide up and down on the right edge of the touchpad to scroll the page up

and down, and slide left and right at the bottom to scroll the page horizontally.

i Tips

Slowly swipe and scroll against the touchpad for better results.

2. Return key: Press it to return to the previous interface.
3. Screen switch button: Turn on/off the infotainment screen.
4. Volume up/down key: Press “+” to increase the volume, and press “-” to decrease the volume.
5. Indicator: Press any button. If the indicator lights up in blue, it means that the battery is full; if the indicator lights up in red, it means that the battery is low and shall be replaced in time.
6. Homepage button: Press it to return to the homepage.
7. Shortcut panel key: press it to enter the shortcut panel interface.





8. Screen angle adjustment: Press the button up and down to adjust the unfolding angle of the infotainment screen.

i Tips

- Before using the remote control for the first time, it is necessary to open the back cover and pull out the battery card.
- It is recommended to store the remote control in the front seat magazine pocket after use.

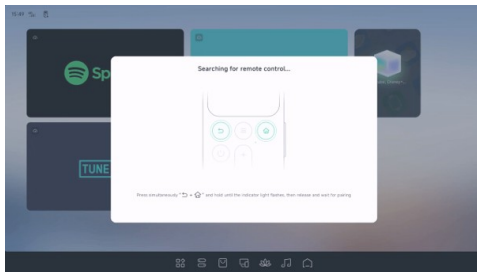
Pairing



When the remote controller is not connected, tap “” on the status bar at the top of the infotainment screen. After a pop-up window appears, press and hold “**Back**” and “**Home**” of the remote controller for more than 3 seconds to enter the pairing mode. The system will automatically complete the pairing after searching the remote controller without other operations.



i Tips

If there is no response from the infotainment screen when operating the remote controller, please check the indicator light of the remote controller first. If the indicator light turns blue after pressing the button, please try to re-pair and connect; if the indicator light turns red, please replace the battery and then try to re-pair and connect.

A/C

Introduction

The A/C can be adjusted by the following ways:

- Mobile App Bluetooth key [See 168 page](#)
- X-Peng voice
- CID
 - Bottom status bar (if set) [See 24 page](#)
 - A/C setting interface
- Rear A/C control panel

Operation

Tap the driver/front passenger A/C module [See 19 page](#) in the bottom status bar of the CID or tap “☰→**Air Conditioning**” [See 24 page](#) to enter A/C settings interface.

Comfort configuration



Front row A/C setting interface



1. Front/rear A/C switching
 - Tap “**Front/Rear**” to switch the front/rear A/C setting interface.
 - It indicates the front/rear A/C ON status.
2. Driver's seat A/C components
 - It indicates the current temperature and air volume of the driver's seat A/C.
 - Adjust the driver's seat A/C.
3. Adjust the temperature of driver's seat
4. A/C mode



- Tap “**SYNC**” to turn on/off the synchronous adjustment of the driver's seat temperature and the front passenger's seat temperature.

i Tips

When the energy-saving mode is selected, the temperature synchronization is automatically turned on.

- A/C: Turn on the rear air-conditioning cooling or heating.
 - AUTO: After it is turned on, the A/C will automatically control according to the set temperature.
5. Blowing mode
- 🌀: window blowing.
 - 🌀: face mode [See 198 page](#).
 - 🌀: foot mode.

i Tips

- Red air indicates that the set temperature is higher than the interior temperature, and the A/C is heating.
- Blue air indicates that the set temperature is lower than the interior temperature, and the A/C is refrigerating.
- Grayish-white air indicates that the set temperature is close to the interior temperature, and the A/C is maintaining the temperature.

6. Turning on/off the front A/C

i Tips

It is recommended not to turn on the A/C system during charging.

7. Adjust the air volume

i Tips

In the blank area of A/C interface, you can select air direction mode .



8. Heating and defrosting/internal and external circulation

- : turn on/off front windscreen defrosting.
- : turn on/off the rear windscreen heater for defrosting and exterior rearview mirror heater for defrosting.

Tips

- Once started, if not manually turned off, the heating function will be automatically turned off by the system after 14 minutes of heating.
- During heating, if the 12V battery voltage is lower than 9V, the system will automatically turn off the heating function.

caution

- When the vehicle is not started, it is not allowed to use the heating and defrosting function for a long time. This could avoid low battery charge of

12V battery, so the vehicle cannot be started.

- When the heating and defrosting function is turned on, do not touch it with your hands.

- : switch between internal and external circulation.

9. Rapid temperature control/intelligent A/C

- Rapid cooling: After it is turned on, the A/C temperature will be adjusted to the minimum and the air volume to the maximum, and the seat ventilation function will be automatically activated.
- Rapid heating: After it is turned on, the A/C temperature will be adjusted to the maximum and the air volume to the maximum, and the seat heating function will be automatically activated.

Tips

To improve the comfort, it is recommended to remotely turn on the



A/C Rapid Cooling/Heating through the mobile App in summer (high temperature) or winter (low temperature).

- ⋮: intelligent mode [See 200 page](#).

10. Adjust the front passenger's seat temperature

11. Front passenger's seat A/C components

- It indicates the current temperature and air volume of the front passenger's seat A/C.
- Adjust the front passenger's seat A/C.

i Tips

Adjusting the front passenger A/C will automatically cancel the synchronization of driver's seat and front passenger's seat.

12. PM2.5 [See 201 page](#)

- Tap the card to turn on/off air purification.
- It displays the air quality inside the vehicle.



Rear A/C setting interface

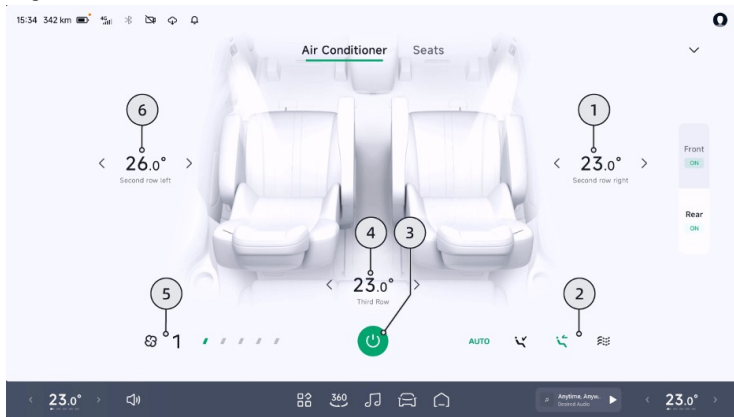

1. Adjustment of second row right temperature
2. Blowing mode
 - : comfort blowing.
 - : rear face mode [See 198 page](#).
 - : rear-row foot mode.
- AUTO: After it is turned on, the A/C will automatically control according to the set temperature.
3. Turn on/off the rear A/C
4. Adjust the third row air temperature
5. Adjust the air volume



6. Adjustment of second row left temperature

Rear A/C control panel

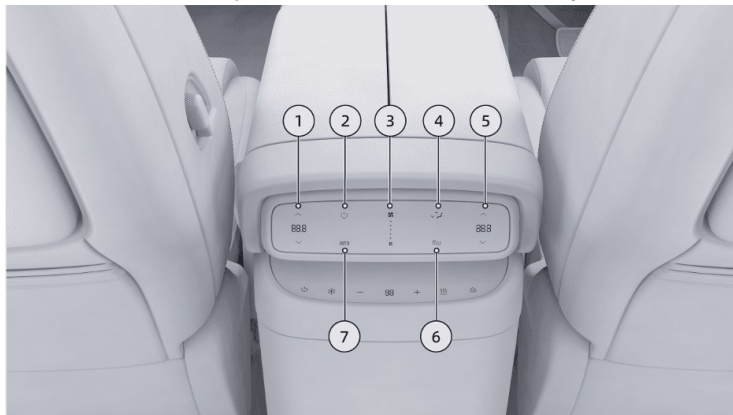

1. Adjustment of second row left temperature

2. Turn on/off the rear A/C

3. Adjust the air volume

4. Blowing mode

- 卍: rear face mode [See 198 page.](#)

- 卐: rear-row foot mode.

5. Adjustment of second row right temperature

6. 卍: comfort blowing



i Tips

- Only the second/third row can start comfort blowing. After it is turned on, the air volume enters the automatic mode.
- After the comfort blowing is turned on, when adjust the air volume of the second/third exhaust, the comfort blowing will be automatically turned off.

7. AUTO: After it is turned on, the A/C will automatically control according to the set temperature.

Air outlet adjustment

Introduction

The front row face blowing mode air outlet can be adjusted on A/C setting interface of the CID and through X-Peng voice, while the second row face blowing mode air outlet can be manually adjusted.

Operation

Adjust front row face blowing air outlet

On the A/C setting interface [See 191 page](#), you can open/close the air outlet, manually adjust the wind direction, and tap on the blank area of the interface to select the airflow mode.

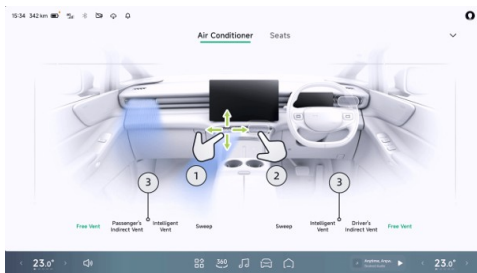

1. Drag the air outlet effect display up and down, left and right to manually adjust the wind direction.
2. Tap the air outlet to open/close the corresponding air outlet.



Comfort configuration

i Tips

After the air outlet is closed, the air outlet effect display becomes a dynamic circle.

3. Vent mode

- Free Vent: Drag the air outlet effect display to adjust the wind direction of single outlet.
- Passenger's Indirect Vent: The air flow of air outlet will avoid the core thorax position of the driver/front passenger seat.
- Intelligent Vent: It intelligently adjusts the airflow direction at the air outlet of the air conditioner according to the interior/exterior temperature and usage scenario.
- Sweep: Drag the air outlet effect display to adjust the sweep height.

i Tips

- Switch to free wind mode after adjusting the airflow direction of a single outlet in the avoidance of the driver/front passenger and smart wind modes.

- After the left and right sweeping mode is turned on, the driver/front passenger air outlet will switch to left and right sweeping mode simultaneously.

Adjust second row face blowing air outlet

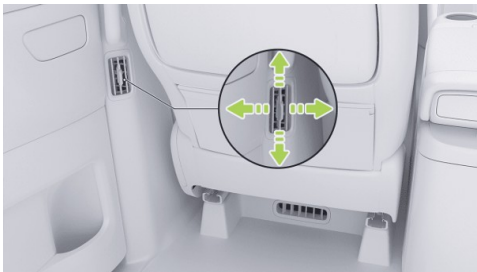

Move the knob left and right to adjust the air flow direction at the air outlet, move it up and down to adjust the air volume, and move it up to the end to close the air outlet.



Intelligent A/C modes

Operation

In the lower left corner of the A/C setting interface See 191 page, tap “...” to select different intelligent A/C modes according to the situation.

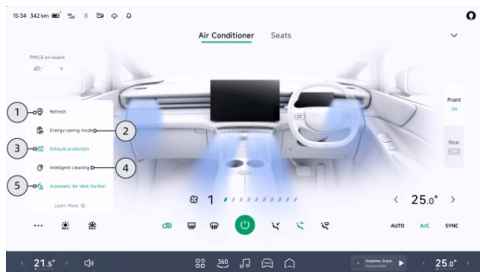

1. Refresh

- Quickly remove the odor in the vehicle with efficient ventilation.

2. Energy-saving mode

- A/C can run in a more power-saving mode to reduce energy consumption and extend the endurance mileage.

i Tips

After this mode is turned on, the cooling or heating performance will be affected to some extent.

3. Exhaust protection

- When the AQS detects that there is exhaust gas pollution outside the vehicle, the A/C will automatically switch to internal circulation mode to ensure the air quality inside the vehicle.

4. Intelligent cleaning

- After the vehicle is unlocked, it can intelligently detect water accumulation in the A/C system and enable the self-drying function to reduce bacteria breeding and reduce the probability of odor in the vehicle.



i Tips

After it is turned on, a certain amount of power will be consumed and the driving range will be slightly affected.

5. Automatic Air Vent Control

- At seats other than the driver's one, the A/C air outlet automatically opens or closes depending on whether the seat is occupied, so as to reduce the power consumption of the A/C and prolong the driving range.

Air purification

Introduction

The air purification function obtains the air quality inside the vehicle through a sensor and network, and displays it on the A/C interface. When the air quality in the vehicle is poor, it will actively remind you to enable the air purification function.

Operation

Opening and closing

On the A/C setting interface [See 191 page](#), tap the area below PM2.5 on the upper left to turn on/off the air purification.

Window

Introduction

The windows can be opened/closed by the following ways:

- Window switch
 - Driver's seat side window switch
 - Front passenger side window switch
 - Slide door window switch
- Mobile App Bluetooth key [See 168 page](#)
- X-Peng voice
- CID setting interface



i Tips

- Please do not open and close the window repeatedly in a short period of time, which will trigger the thermal protection of the window. After the thermal protection is activated, the window lifting/lowering function will be disabled and need to wait for about 2 minutes to be enabled again.
- When the window is controlled to close, if it is blocked by an obstacle in the anti-pinch area, the window will stop closing and return for a certain distance.
- Window initialization can be performed if the button-to-close and anti-pinch functions of window are invalid.

⚠ warning

- When there is a child in the vehicle, to ensure safety, the passenger window shall be locked to prevent the child from operating the window and avoid pinching.

- Even if the window is equipped with anti-pinch function, there is still a possibility of pinching when the window is closed. Do not activate the anti-pinch function by blocking the closing of the window with any part of your body.
- Before closing the window, the driver must ensure that all passengers (especially children) do not lean any body part out of the window; otherwise, it may cause pinch injury!
- After the automatic window closing function is enabled, the windows will close automatically when the vehicle is locked. Please make sure that the windows will not catch passengers or obstacles and there are no passengers (especially children) in the vehicle before locking.
- Before leaving the vehicle, make sure that it is powered off.



Operation

Driver's seat side window switch

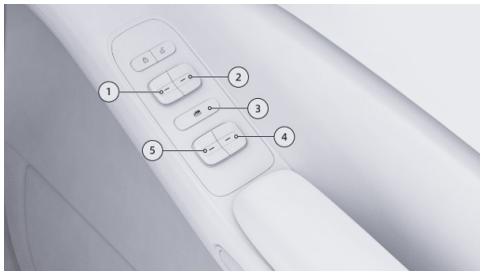

1. Front left window regulator switch
2. Front right window regulator switch
3. Locking switch of passenger door glass regulator
4. Rear right window regulator switch
5. Rear left window regulator switch

Front passenger side window switch



Short press the front/rear part of the switch: One-key up/down function is activated, and the window will automatically move to the fully closed/open position.

Long press the front/rear part of the switch: The window starts to rise/fall, and release it to stop.



Slide door window switch



Short press the UP/DOWN button: One-key up/down function is activated, and the window will automatically move to the fully closed/open position.

Long press up/down: The window starts to rise/fall, and release the button to stop.

CID setting interface

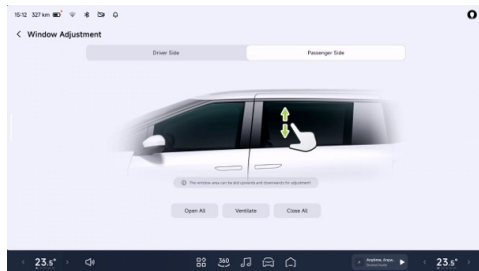

On the “**Window & Door**→**Window Adjustment**” interface of the CID, you can set “**Open All, Ventilate, Close All**” for windows. You can also swipe up and down in the window area for adjustment.

i Tips

When the passenger window glass lifter lock is turned on, the indicator lamp on the switch illuminates. At this time, the window switches on other doors are disabled and all windows



can only be adjusted by the driver's seat side window switch.

Automatic window closing

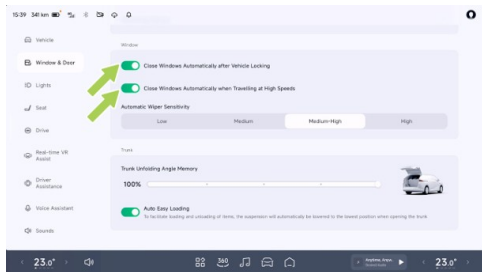

On the “**Window & Door**” interface of the CID, you can turn on/off “**Close Windows Automatically after Vehicle Locking**” and “**Close Windows Automatically when Traveling at High Speeds**”.

i Tips

After enabling Close Windows Automatically when Traveling at High Speeds during high-speed driving, it is recommended to switch to the external circulation mode during high-speed driving.

Window initialization

Window initialization can be performed if the window function is abnormal (such as failure of one-key up/down, and CID and voice adjustment):

1. Power on the vehicle and close the door. Operate the driver's seat window switch upward to fully close it and hold it for at least 2 seconds, and then release.
2. Operate the driver's seat window switch downward to fully open it and hold it for at least 2 seconds.



Sunshade

Introduction

The vehicle is equipped with several sunshades, including:

- Front row manual sunshade
- Rear electric sunshade

Can be opened/closed by:

- Rear sunshade switch
- Mobile App Bluetooth key [See 168 page](#)
- X-Peng voice
- CID setting interface
- Window sunshade

i Tips

- The rear sunshade will stop closing and return for a certain distance if it is obstructed by an obstacle in the anti-pinch area when pressing the button to close the sunshade.

- If the rear sunshade cannot function normally, it is allowed to initialize the sunshade.

! warning

Even if the sunshade is equipped with an anti-pinch function, there is still a possibility of pinching when the sunshade is closed. Do not activate the anti-pinch function by blocking the closing of the sunshade with any part of human body.



Operation

Front row manual sunshade



To use the sunshade, push it forward to its forefront end; if not used, retract it backward.

Rear electric sunshade

Rear sunshade switch



Press the forward/backward switch: The sunshade will automatically move to the fully closed/open position.

CID setting interface



On the “☰→Window & Door→Sunshade Adjustment” interface of the CID, you can set “Open All, Stop, Close All” for sunshades. The sunshade area can also be slid left and right for adjustment.

Sunshade initialization

During operation of the sunshade, if any function is abnormal (for example, the switch, CID and voice cannot be adjusted), initialization of the sunshade can be performed:

1. In the sunshade adjustment interface, tap and hold “Close All” for 3 seconds to start the initialization of sunshade.
2. The sunshade position will be adjusted automatically. After successful resetting, the system prompts “The sunshade is being reset” and initialization is completed.

Window sunshade

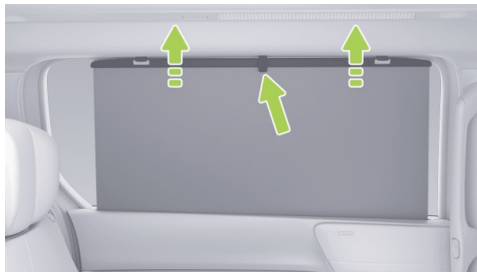

To use the sunshade, pull it up and hang it on the hook at the top of window. Retract the sunshade when it is not in use.



Reading light

Introduction

You can turn on/off the reading light by the following means:

- Reading light switch
- CID
 - Setting interface
- X-Peng voice

i Tips

The reading light will turn on automatically when the door is opened, and turn off automatically when the door is closed.

⚠ warning

Do not turn on the front reading light when the vehicle is running in weak ambient lighting. Reflection may appear on the windscreen, making it difficult to see the road ahead and causing accidents.

Operation

Reading light switch

Front reading light



The reading light is installed in the front roof light assembly. It will turn on by touching the lightshade, and turn off by touching the lightshade again.

Second/third-row reading lights



The reading light will turn on when the lightshade on the same side is touched, and turn off when the lightshade is touched again.

CID setting interface

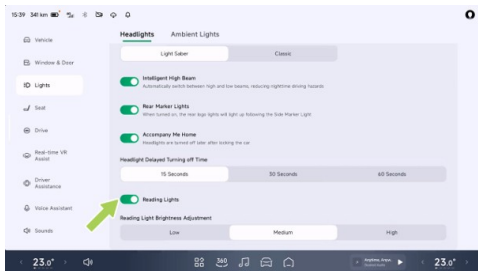

On the L “[🚗](#)→**Lights**→**Headlights**” interface of the CID, you can turn on/off “**Reading Lights**”, and adjust the brightness after the reading light is turned on.

Ambient light

Introduction

You can turn on/off and set the ambient light by the following means:



Comfort configuration

- CID setting interface
- X-Peng voice

Operation

CID setting interface

On the “→Lights→Ambient Lights” interface of the CID, you can set the ambient light

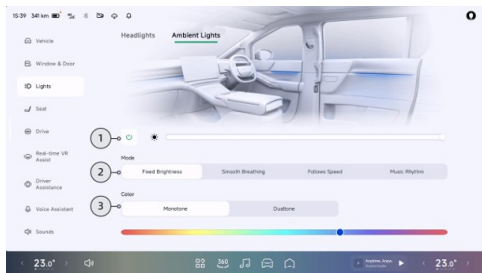

1. Turn on/off the ambient light.
 - Adjust the brightness of ambient light after the ambient light is turned on.

2. Mode selection: select “**Fixed Brightness, Smooth Breathing, Follows Speed and Music Rhythm**” according to your preference.
3. Color selection: select “**Monotone**” or “**Dualtone**” according to your preference.

Electric open/close refrigerator with cooling and heating functions

Introduction

You can control the CF by the following means:

- CF control panel
- Mobile App Bluetooth key [See 168 page](#)

i Tips

It only supports turning on/off the refrigerator refrigeration or heating function and timing.

- X-Peng voice
- CID
 - Shortcut panel [See 25 page](#)



i Tips

It only supports opening/closing the refrigerator door.

- Setting interface

Operation

CF control panel



1. Power on/off the refrigerator.

i Tips

After the function is enabled, the refrigerator setting before the last power-off will be maintained.

2. Refrigeration mode: The temperature setting range is 0°C~20°C.
3. Decrease the refrigerator temperature.
4. Display the refrigerator temperature.
5. Increase the refrigerator temperature.
6. Heating mode: The temperature setting range is 30°C~50°C.
7. Open/close the refrigerator door.

! caution

- If the refrigerator door is not closed for a long time, CID and X-Peng will give voice prompts.
- The refrigerator door can be opened/closed electrically. Do not open/close it manually by violence, otherwise, the door will be damaged.



- Do not adjust the second-row seats when the refrigerator door is open to avoid crash between the seat and the refrigerator, resulting in hardware damage.

CID setting interface

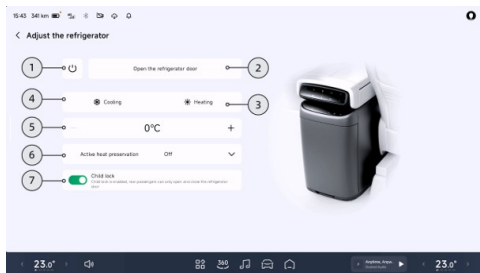

On the “**Device** **Connection**→**Devices**→**Refrigerator**” interface of the CID, you can set various CF functions.

- Power on/off the refrigerator.
- Open/close the refrigerator door.

- Heating mode: The temperature setting range is 30°C~50°C.
- Refrigeration mode: The temperature setting range is 0°C~20°C.
- Adjust the refrigerator temperature.
- Set the thermal insulation time after the vehicle is locked.
- Open/close the childproof lock. After the function is enabled, rear passengers can only open/close the refrigerator door.

caution

It is recommended to open the childproof lock when there are children in the vehicle, to prevent misoperation by children that may change the refrigerator settings.

Seat heating

Introduction

You can control the seat heating by the following means:

Comfort configuration



- Second-row seat heating switch
- Mobile App Bluetooth key [See 168 page](#)
- X-Peng voice
- CID
 - Bottom status bar (if set) [See 24 page](#)

i Tips

The bottom status bar only supports controlling the heating of driver's/front passenger's seat.

- Setting interface

Operation

Second-row seat heating switch

Configuration I*



Configuration II*





Press the second-row seat heating switch to activate the seat heating function. The switch shifts between gears 3, 2, 1, OFF repeatedly, and the indicator will display the gear at the same time.

CID setting interface

On the A/C settings interface [See 191 page](#), tap “**Seats**” to enter the Settings interface.



Tap “” to activate the heating function of the corresponding seat. When it is set at Level 3, you

can repeatedly tap it in a cycle of Level 2, Level 1, Off and Level 3.

warning

- If the body of the driver/passengers in contact with the seat cannot feel pain, please do not enable the seat heating function; otherwise, personal injury may be caused.
- Low-temperature scald may be caused by long-term high-gear heating of seats.
- The driver may feel sleepy if his/her seat is heated for a long time, thus affecting driving safety.

caution

If the second-row seats are equipped with child safety seats, please do not enable the seat heating function.



Seat ventilation

Introduction

You can control the seat ventilation by the following means:

- Second-row seat ventilation switch
- Mobile App Bluetooth key [See 168 page](#)
- X-Peng voice
- CID
 - Bottom status bar (if set) [See 24 page](#)

i Tips

Only driver's/front passenger's seat is supported.

- Setting interface

Operation

Second-row seat ventilation switch

Configuration I*



Configuration II*





Comfort configuration

Press the second-row seat ventilation switch to activate the seat ventilation function. The switch shifts between gears 3, 2, 1, OFF repeatedly, and the indicator will display the gear at the same time.

CID setting interface

On the A/C settings interface [See 191 page](#), tap “**Seats**” to enter the Settings interface.



Tap “**☼**” to activate the ventilating function of the corresponding seat. When it is set at Level 3, you

can repeatedly tap it in a cycle of Level 2, Level 1, Off and Level 3.

caution

If the second-row seats are equipped with child safety seats, please do not enable the seat ventilation function.

Seat message

Introduction

You can control the seat massage by the following means:

- Second-row seat massage switch
- X-Peng voice
- CID
 - Shortcut panel [See 25 page](#)

Tips

After “**Massage**” is selected, a seat massage interface will pop up, where you

Comfort configuration



can set the front and second-row seat massage functions.

- Setting interface
- Infotainment screen shortcut panel [See 26 page](#)

i Tips

After **"Massage"** is selected, a seat massage interface will pop up, where you can only set the second-row seat massage function.

Operation

Second-row seat massage switch

Configuration I*



Configuration II*





Comfort configuration

1. Message mode switch

- Press to switch between the six message modes.

2. Message intensity adjustment switch

- Press this switch to activate the seat message function. The switch shifts between gears 3, 2, 1, OFF repeatedly, and the indicator will display the gear at the same time.

CID setting interface

On the “**Seat**→**Message**” interface of the CID, you can set the seat message function.

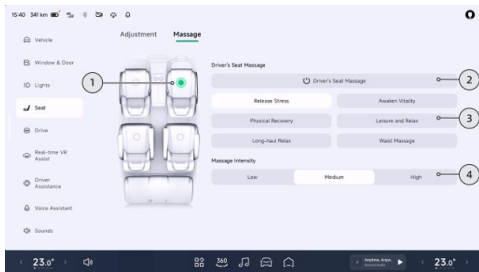

1. Tap to select the seat to be adjusted.
2. Tap to enable/disable the seat message function.
3. You can choose the message mode according to your preference, and tap to enable the seat message function.

Tips

Different message modes correspond to different message durations. The function will be disabled when the time is reached.

4. Tap to select the message intensity.



⚠ caution

If the second-row seats are equipped with child safety seats, please do not enable the seat massage function.

Driver's audio

Operation

CID setting interface

On the “🚗→Sounds→Driver's Speaker” interface of the CID, you can set the driver's seat sound mode.

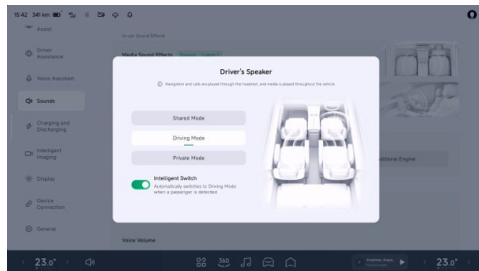

- Shared Mode: All sounds are played throughout the vehicle.
- Driving Mode: Navigation and communication sounds are played through the driver's headrest audio system, which does not affect the music experience.
- Private Mode: All sounds are played through the driver's headrest audio system, and voice control function is only available from the driver's seat.

After the “**Intelligent Switch**” is turned on, the vehicle will switch to the “**Driving Mode**”



automatically if the front passenger's seat is occupied.

Storage space

Introduction

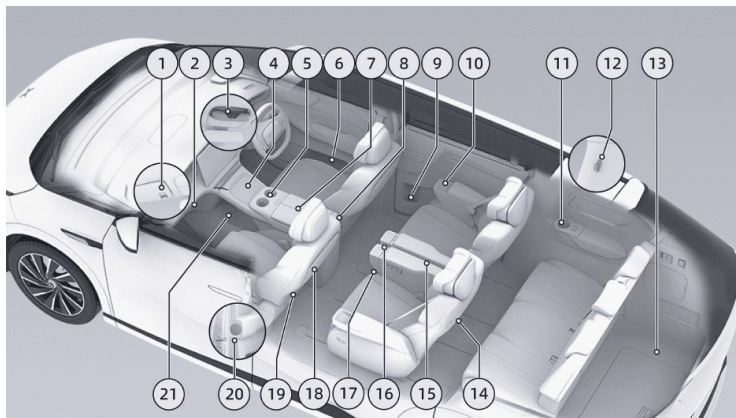

1. Clamp
2. Glove box
3. Glasses holder
4. Front-row wireless charging [See 239 page](#)
5. Front-row cup holder
6. Door storage box
7. Central armrest box

Comfort configuration



8. Electric open/close refrigerator with cooling and heating functions [See 211 page](#)
9. Slide door cup holder
10. Second row wireless charging* [See 239 page](#)/Second row seat cup holder*
11. Third-row side panel cup holder
12. Hook
13. Trunk [See 180 page](#)
14. Second-row seat magazine pocket
15. Second-row seat mobile phone panel*
16. Second-row seat cup holder*
17. Second-row seat mobile phone holder
18. Foldable tray
19. Front seat magazine pocket
20. Umbrella holder
21. Through storage compartment

Operation

Clamp



The sun visor is provided with clamps, which can be used to hold various cards such as business cards, expressway pass cards, etc.



Comfort configuration

Glove box



Press the glove box unlock button to open the glove box, and push it back and lock it when it is not in use.

Glasses holder



Press the glasses holder to open it slowly, and push it back upwards to close it.

Comfort configuration



Front-row cup holder



The console is equipped with a cup holder to hold drink bottles or cups.

caution

Do not put fine articles and other sundries into the cup holder to prevent jamming.

warning

Do not place any open drink bottle or cup in the cup holder when the vehicle is running, to prevent the hot drink from splashing out

and scalding passengers in the vehicle or damaging the vehicle and electrical equipment in the vehicle.

Door storage box



There is a storage box in lower part of the door, which can store drink bottles or articles.



Comfort configuration

Central armrest box



The console is equipped with a central armrest box, which can be opened by pressing the switch.

Slide door cup holder



There is a cup holder in the lower part of the Slide door to hold drink bottles or cups.



Third-row side panel cup holder



The third-row side panel is equipped with a cup holder to hold drink bottles or cups.

Hook



There are hooks on the upper part of third-row seats.

⚠ caution

Do not hang objects over 3 kg to avoid damaging the hooks.

⚠ warning

Do not hang any hard objects (such as clothes hangers, fruits and glass bottles) to prevent injury when the side curtain airbag is deployed.



Trunk

The trunk can be used to place luggage and goods.

warning

- Do not store fragile, inflammable and explosive dangerous goods in the trunk to avoid fire, explosion or damage to goods.
- Liquids being stored must be sealed to avoid damage to the vehicle due to leakage. In case of leakage, please clean it in time.
- Do not drive the vehicle when it is overloaded, to avoid long braking distances due to excessive inertia, thus leading to accidents.

Second-row seat magazine pocket



A map pocket is provided on the second-row backrest for storing bills, magazines and other items.

Comfort configuration



Second-row seat mobile phone panel*

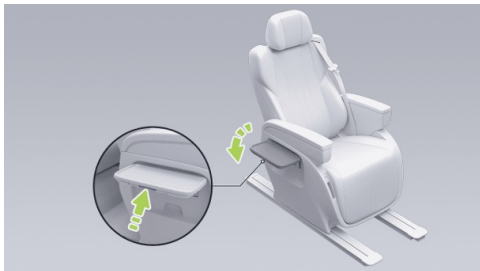

A foldable mobile phone panel is provided in the middle of the second-row seats for temporary storage of mobile phones. When it is not in use, press and hold the switch below the outer side of the panel to retract the panel.

⚠ warning

Pay attention to the rotation structure when retracting the mobile phone panel, and be careful not to pinch your hands.

⚠ caution

Do not place heavy objects on the mobile phone panel to avoid crushing the panel.

Second-row seat cup holder

Configuration I*



The inner armrest of the second-row seat is equipped with a cup holder to hold drink bottles or cups. Press the switch to eject the cup holder, and push it back to lock it when not in use.

Configuration II*



Comfort configuration



The outer armrest of the second-row seat is equipped with a cup holder to hold drink bottles or cups. It can be pulled out when in use and pushed back when not in use.

caution

Do not put fine articles, sundries or heavy objects into the cup holder to prevent jamming or damage.

warning

Do not place an open cup on the cup holder when the vehicle is running, to prevent the hot drink from splashing out and scalding passengers in the vehicle or damaging the vehicle and electrical equipment in the vehicle.

Second-row seat mobile phone holder

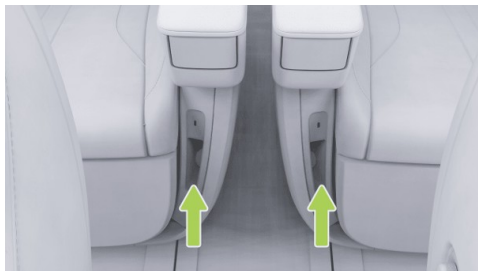

A mobile phone holder is set under the inner side of the second-row seat to hold a mobile phone.

Comfort configuration



Foldable tray



There is a foldable tray on the back of the front seat, which can be unfolded by pressing the switch, and folded when not in use.

caution

The load-bearing capacity of the foldable tray is less than or equal to 10 kg.

warning

- Pay attention to the rotation structure when operating the foldable tray, and be careful not to pinch your hands.
- Do not use it when the vehicle is running.
- Please follow the rules of use, otherwise serious injury or even death may be caused.

Front seat magazine pocket





Map pockets are provided on the back of front seats for storing articles such as remote control, bills and magazines.

Umbrella holder



The front passenger door is equipped with push-type umbrella holder.



After prying off the umbrella holder cover with a suitable tool (key card covered by soft cloth/wrapped in adhesive tape or similar), the umbrella can be stored or taken out:

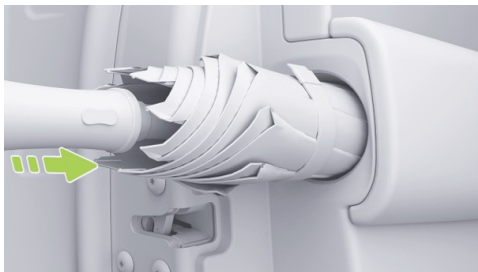

- Store the umbrella: After the umbrella is folded, push it into the umbrella holder with the top facing forward until you hear a click sound.



- Take out the umbrella: Press the umbrella forward and pop up the handle, so that you can take out the umbrella.



Comfort configuration

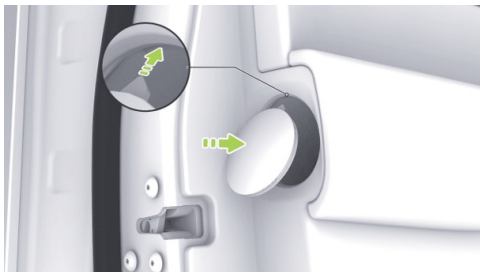

Insert the pin of the umbrella holder cover into the bayonet of the trim panel, and press the umbrella holder cover to reinstall it.

i Tips

- If you need to pry up the umbrella holder cover with a hard tool (slotted screwdriver, etc.), it is recommended to wrap several layers of adhesive tape around the tool to avoid scratching the interior trims.
- Only umbrellas with a length of less than 36 cm and a diameter of less than 6

cm after folding can be stored in the umbrella holder, otherwise, the umbrella holder may be damaged. It is recommended to store XPENG official umbrellas whose size matches that of umbrella holders. Magnets are also equipped on the top of umbrellas for more stable loading.

- Please dry the umbrella before inserting it, otherwise, it is easy to breed bacteria or cause mildew.
- Please clean the umbrella holder regularly.
- The umbrella holder cover is easy to lose. It is recommended to put it back after storing or taking out the umbrella.

Comfort configuration



Through storage compartment



The through storage compartment is located in front lower part of the console.

Steering wheel buttons

Operation

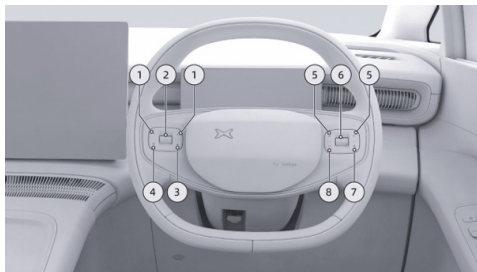

1. Left and right buttons
 - It is used to adjust the A/C air flow.
 - With the ACC/LCC activated, adjust the cruise distance.
 - Adjust the left exterior rearview mirror to turn leftward or rightward on the exterior rearview mirror adjustment interface.
2. Upper and lower scroll buttons



- The A/C temperature is adjusted by default.
 - Tap and hold it to enter the card switching mode on the left screen of the instrument, scroll up and down to select cards, and tap to confirm selection.
 - Scroll up and down to turn over the left exterior rearview mirror on the exterior rearview mirror adjustment interface.
 - Scroll up and down to zoom in/out the field of view of the streaming interior rearview mirror on the streaming interior rearview mirror adjustment interface.
3. Steering wheel shortcut key
 - Tap and hold this key to set the function of it, and tap it to execute the set function.
 4. Voice wake-up button
 - Wake up or cancel X-Peng voice.
 5. Previous/next song button
 - After awakening a song, tap to play the previous or next radio station/chapter/song.
 6. Upper and lower scroll buttons
 - The media volume is adjusted by default.
 - Tap the multimedia play/pause/instrument pop-up window to confirm.
 - Tap and hold it to enter the card switching mode on the right screen of the instrument, scroll up and down to select cards, and tap to confirm selection.
 - When there is a phone call, scroll up/down to select Answer/Reject, and tap to confirm. After answering the call, tap it to hang up.
 - Scroll up and down to tilt the right exterior rearview mirror on the exterior rearview mirror adjustment interface.
 - Scroll up and down to adjust the upper and lower positions of the field of view of the streaming interior rearview mirror on the streaming interior rearview mirror adjustment interface.



7. Mute button

- Mute or unmute.

8. Return key

i Tips

If the instrument or CID displays abnormally and the screen is suddenly stuck, tap and hold the voice wake-up button and mute button at the same time to restart the instrument and CID. If the fault is still not eliminated after restart, please contact the XPENG Service Center for maintenance in time.

Set steering wheel shortcut key

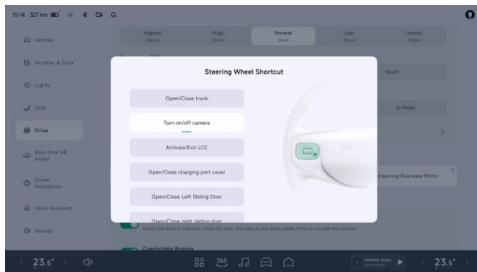

By pressing and holding the steering wheel shortcut key, or on the “**Drive**→**Steering wheel Shortcut**” interface of the CID, you can set the steering wheel shortcut key function.

External V2L discharge

Introduction

In the vehicle, discharging equipment can be used to provide the power of traction battery



for other electrical appliances, with a discharge voltage of 220V and a maximum power of 3.3 kW.

warning

- It is strictly prohibited to enable the external discharging function when the external electrical appliance or charging gun is damaged.
- Children must not touch, use, or approach the charging gun.
- When the power supply is abnormal, please stop external discharging immediately.
- It is strictly prohibited to touch the pins of electrical appliances and the sockets of charging gun.
- It is strictly prohibited to use counterfeit and inferior products, medical or health electronic devices.

Operation

1. Open the charge port.

2. Insert the charging gun into the AC charging port of the vehicle.
3. Tap **“Start charging”** See 56 page.
4. After charging is completed, tap **“Stop charging”**.
5. Press and hold the unlock button of the charging gun and pull out the charging gun.

Tips

- The charging limit can be set, and the charging will stop automatically when the traction battery power reaches the limit.
- When the traction battery power is less than 20%, the external discharging function is not available.

Warnings, cautions and limitations

warning

- It is strictly forbidden to use the alternating current power supply function when the external electric appliance or power supply charger is damaged.



- It is strictly forbidden to let minors touch or use the power supply charger, and do not let minors approach the power supply charger when it is in use.
- Please immediately stop using the alternating current power supply function when the power supply is abnormal.
- It is strictly forbidden to touch the power supply charger connector pins of the electrical consumer and the charging port holes.
- It is strictly forbidden to use counterfeits and medical or health care electronic devices.
- Do not use products that require a continuous power supply, such as medical equipment. The power supply may be interrupted depending on the vehicle's condition.
- Put the power plug fully and use the qualified plug that meets the standard. If you use worn, corroded or broken plug or improper plug, it might be a cause of malfunction.
- Do not use high power home appliances that pull current for a long time such as air conditioning, washing machine or dryer, etc.
- Do not hang the home appliances on the adapter.
- For devices used outdoors in a vehicle, use a product with a waterproof function or use it in a waterproof environment. Do not use in environments with rain or high humidity. (Electrical appliances, multi-outlets, cord extension cables, etc.)
- If there is a risk of lightning, do not use the V2L function outside the vehicle.
- Do not connect multiple portable multi-outlets.
- When using an extension cable, if the cable is twisted or overlapped by itself may cause a fire. Be sure to use the cable without twisting it.



Wireless phone charging

Introduction

The following functions can be activated after wireless charging at the corresponding position is enabled on the CID setting interface:

- Front-row wireless charging
- Second-row wireless charging*

Tips

Mobile phones support a maximum wireless charging power of 50W, and have the air cooling capability. It is used to cool the mobile phone, thus improving the charging efficiency.

caution

Some mobile phones do not have wireless charging function. Placing the mobile phone on the wireless charging panel may cause screen flashing and other faults. If necessary, it is recommended to disable the wireless charging function in CID.

Operation

Opening and closing

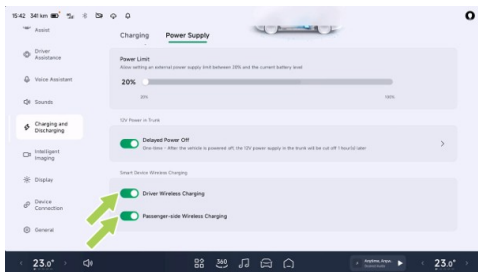

On the “→**Charging and Discharging**→**Power Supply**” interface of the CID, you can enable/disable the wireless charging function (if equipped) of front-row and second-row seats.



Front-row wireless charging



The front-row wireless charging area is located in the front of the console. During charging, please face the mobile phone screen upward and slide the mobile phone to the bottom of the charging area along the limit bar, which is conducive to inductive charging and heat dissipation of the mobile phone. During charging, “Qi” is displayed on the CID.

Second-row wireless charging*



The second-row wireless charging area is located at the outer armrest of the seat. During charging, please face the mobile phone screen upward and slide the mobile phone to the bottom of the charging area along the limit bar.

Warnings, cautions and limitations

Wireless charging will be stopped in the following cases:



- When the mobile phone is placed at the top of the charging area, there may be charging or induction failure.
- When a metal foreign object is identified between the mobile phone and the wireless charging module, detection will be triggered to stop charging.

caution

- Mobile phones with a 50W wireless fast charging function must be placed at the bottom of the charging area along the limit strip, and the bottom of the mobile phone shall completely cover the air outlet to avoid overheating.
- The air outlet of the wireless charging cooling fan is located at the lower end of the wireless charging module. No foreign object or liquid shall enter the air outlet to affect the operation of the fan.
- Do not sprinkle water in the wireless charging area, to avoid water entering

wireless charging module to cause damage to electronic components.

- When leaving the vehicle, do not place the mobile phone in the vehicle for charging to avoid potential safety hazards.
- Do not place heavy objects in the charging area to avoid damage to the wireless charging module.
- If the wireless charging function fails or cannot work normally, please stop charging and contact the XPENG Service Center for maintenance.
- The mobile phone will heat up after long-time charging, which is normal. Do not place equipment in the charging area after it is fully charged, to avoid overheating.
- Do not use a mobile phone case with metal material, such as one supporting magnetic charging (MagSafe).



warning

- Metal can be heated when the mobile phone wireless charging function is activated, therefore, charging can be started only if it is confirmed that there is no metal object on the back of the mobile phone or in the charging area; otherwise, the metal object may be heated or damaged, or even safety accidents may be caused. Metal objects here refer to objects containing metal, including but not limited to chips and magnetic cards.
- External wireless charging coil may cause accidents, which must be used with caution.

Sun visor and vanity mirror

Introduction

Sun Visor



Sun visor can be flipped down in the direction of arrow to block sunlight coming in through front windscreen.



Comfort configuration



After flipping down the sun visor, take out one end of the sun visor which is close to the interior rearview mirror from the bracket and turn over the sun visor towards the window to block sunlight coming in through the window.

warning

Sun visor which is flipped down may affect the front view. Please take it back if it is not in use.

Vanity mirror



Both driver's and front passenger's sun visors are equipped with vanity mirrors. The vanity mirror light will turn on automatically when the sun visor is flipped down and the vanity mirror cover is lifted, and turn off when the vanity mirror cover is closed.



Charging and data ports

Introduction

The vehicle is equipped with multiple charging and data ports:

- Front port of central armrest box
- Inner port of second-row seat
- Third-row side panel port
- Internal port of trunk

warning

Do not modify the Type-C port without permission.

Operation

Front port of central armrest box



1. USB media source port: It is used for data transmission*(if applicable), microphone, game controller, etc.

caution

It is forbidden to use the USB media source port for charging, which may cause CID restart or black screen.



Comfort configuration

2. Type-C power port: It is used for data transmission and charging of electronic equipment, and supports standard charging protocol, with a maximum power of 60W.
3. 12V power port: It has the maximum power of 180W.

Inner port of second-row seat

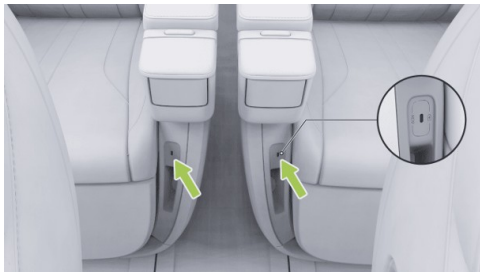

A Type-C power port is provided under the inner armrest of the second-row seat, with a maximum power of 60W.

Third-row side panel port



There is one Type-C power port on the third-row left and right side panels respectively, with a maximum power of 15W.

Comfort configuration



Internal port of trunk



The trunk is equipped with a 12V power port, with a maximum power of 180W.

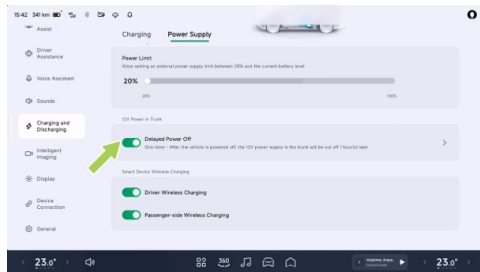

On the “**🚗**→**Charging and Discharging**→**Power Supply**” interface of the CID, after turning on “**Delayed Power Off**”, you can set the delayed power-off time of the trunk 12V power supply after the vehicle is powered off.

Second-row seats Easy Entry/Exit

Introduction

The second-row seats Easy Entry/Exit function can be enabled by the following means:



Comfort configuration

- Easy Entry/Exit switch
 - Side switch
 - Back switch
- X-Peng voice
- CID setting interface

i Tips

When the second-row seats Easy Entry/Exit function is abnormal (for example, the switch, CID, or voice cannot be adjusted), you can try manual initialization before use.

Operation

Easy Entry/Exit switch

Side switch



Back switch





- Entry/exit of third-row seats: Press the forward switch to move the driver's/front passenger's seat (unoccupied) on corresponding side forward, move the second-row seats forward, fold the backrest forward by a certain angle, and retract the leg support to facilitate passengers' entry/exit.

i Tips

- If the driver's/front passenger's seat is occupied, no forward movement will be performed.
- If the driver's/front passenger's seat is occupied but positioned forward with the backrest angle upright, the second-row seats will move to the foremost position.
- If the driver's/front passenger's seat is occupied but positioned backward and the backrest angle is large, the second-row seats will only move to a relatively forward position.
- The second-row seats will stop moving when any switch on them is pressed, any

person sits on them, the gearshift lever is not in P position or the vehicle speed is higher than zero.

- After leaving the vehicle or sitting on a third-row seat: Press the backward switch to restore the second-row seats to their default positions.

CID setting interface

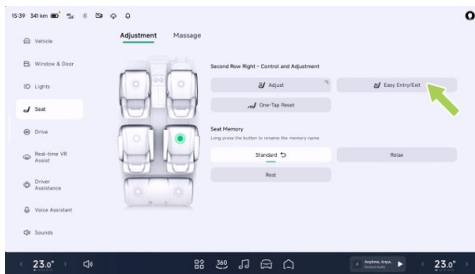

On the “**Seat→Adjustment**” interface of the CID, select a second-row seat, and tap “**Easy Entry/Exit**” to realize easy entry/exit.



Zero gravity mode*

Introduction

In the zero gravity mode, the second-row seats will move automatically to make human body in the most relaxed state to ensure even support for passengers' spine and improve riding comfort.

You can adjust the zero gravity mode by the following means:

- Zero gravity switch
- X-Peng voice
- CID setting interface
- Infotainment screen shortcut panel [See 26 page](#)

warning

Do not enter “**zero gravity**” mode during driving.

Tips

When the second-row seats Zero Gravity Mode is abnormal (for example, the switch, CID, or voice cannot be adjusted), you can try manual initialization before use.

Operation

Zero gravity switch

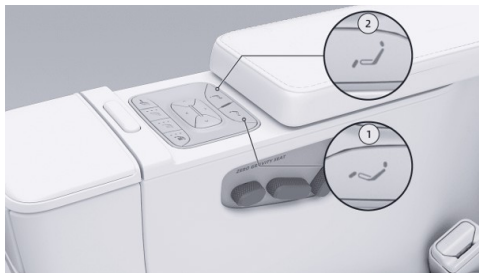

1. Zero gravity switch

- Press the switch to make the seat enter the zero gravity mode.



i Tips

- If the driver's/front passenger's seat is too backward and unoccupied, the front seats will move forward before entering the zero gravity mode.
- If the driver's/front passenger's seat is too backward, the second-row seat leg support may not be fully extended in zero gravity mode.
- If the driver's/front passenger's backrest is too backward, it may not be able to enter the zero gravity mode, and you can adjust the driver's/front passenger's seat and try to enter the mode again.
- If the third-row backrest is too forward, it may not be able to enter the zero gravity mode. It is impossible to enter the zero gravity mode when the third-row backrest is folded; you can adjust the third-row seat and try to enter the mode again.

- Press this switch to reset the second-row seats from zero gravity mode.

i Tips

If the driver's/front passenger's seat moves forward before entering the zero gravity mode, it will not be reset when the zero gravity mode is reset.

CID setting interface

On the “☰→**Seat→Adjustment**” interface of the CID, select a second-row seat, tap “**Zero gravity**” to enter the zero gravity mode, and tap “**Reset**” to restore the default position.

2. Reset switch



Horn

Introduction



Tap the horn mark area to sound the horn.

caution

Do not tap the horn mark area for a long time; otherwise, it is easy to damage the horn.

Seat adjustment

Introduction

You can adjust seats by the following means:

- Seat switch
- CID setting interface
- Infotainment screen shortcut panel [See 26 page](#)
- X-Peng voice

Tips

- The driver's seat, front passenger's seat and second-row seats have a position memory function, so that different passengers can adjust the seat positions quickly.
- Remove the seat headrest (the driver's headrest cannot be removed), adjust the seat to a proper position, and lay down the backrest to obtain more space for riding or trunk.



i Tips

If functions such as seat memory, seat welcome, seat position, and CID adjustment cannot work normally, you may try initialization.

Operation

Adjustment of driver's seat with seat switch

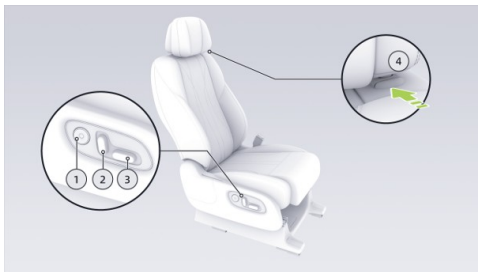

1. Lumbar support adjustment switch

- Adjust the jacking position of lumbar support: Press the Up/Down button.

- Adjust the jacking height of lumbar support: Press the Left/Right button.
- #### 2. Backrest angle adjustment switch
- Adjust the backrest angle: Push the top of the switch forward/backward.
- #### 3. Seat/cushion adjustment switch
- Horizontal adjustment of seat: Move the switch forward/backward.
 - Vertical adjustment of seat: Push the rear part of the switch upward/downward.
 - Cushion height adjustment: Move the front part of the switch upward/downward.
- #### 4. Headrest switch
- Adjustment of headrest height: Push the headrest upward to raise the headrest; press and hold the switch to lower the headrest.



i Tips

- When you hear a “click” during headrest adjustment, it indicates that the headrest is locked in place.
- The driver’s headrest cannot be removed.

Adjustment of front passenger's seat with seat switch



1. Seat/cushion adjustment switch

- Horizontal adjustment of seat: Move the switch forward/backward.
 - Vertical adjustment of seat: Push the rear part of the switch upward/downward.
 - Cushion height adjustment: Move the front part of the switch upward/downward.
2. Backrest angle adjustment switch
 - Adjust the backrest angle: Push the top of the switch forward/backward.
 3. Lumbar support adjustment switch
 - Adjust the jacking position of lumbar support: Press the Up/Down button.
 - Adjust the jacking height of lumbar support: Press the Left/Right button.
 4. Backrest angle adjustment switch (boss key)
 - Adjust the backrest angle: Push the top of the switch forward/backward.
 5. Seat adjustment switch (boss key)
 - Horizontal adjustment of seat: Move the switch forward/backward.



6. Headrest switch

- Adjustment of headrest height: Push the headrest upward to raise the headrest; press and hold the switch to lower the headrest.

i Tips

When you hear a “**click**” during headrest adjustment, it indicates that the headrest is locked in place.

- Removal of headrest: Press the switch and pull it upward to remove the headrest.

Adjustment of second-row seats with seat switch

Configuration I*



1. Lumbar support adjustment switch

- Adjust the jacking position of lumbar support: Press the Up/Down button.
- Adjust the jacking height of lumbar support: Press the Left/Right button.

2. Headrest adjustment switch

- Adjustment of headrest: Toggle the switch forward/backward/upward/downward.

3. Backrest angle adjustment switch

- Adjust the backrest angle: Push the top of the switch forward/backward.



4. Seat adjustment switch
 - Horizontal adjustment of seat: Move the switch forward/backward.
5. Leg support adjustment switch
 - Adjustment of leg support: Toggle the switch forward/backward/upward/downward.
6. Easy Entry/Exit switch (side) [See 246 page](#)
7. Easy Entry/Exit switch (back) [See 246 page](#)

Configuration II*



1. Lumbar support adjustment switch
 - Adjust the jacking position of lumbar support: Press the Up/Down button.
 - Adjust the jacking height of lumbar support: Press the Left/Right button.
2. Seat and leg support adjustment switch
 - Horizontal adjustment of seat: Move the switch forward/backward.
 - Adjustment of leg support angle: Push the front part of the switch upward/downward.
3. Backrest angle adjustment switch
 - Adjust the backrest angle: Push the top of the switch forward/backward.
4. Easy Entry/Exit switch (side)
 - The operation is the same as configuration I.
5. Easy Entry/Exit switch (back)
 - The operation is the same as configuration I.
6. Headrest switch



- The operation is the same as that of front passenger's seat.

Adjustment of third-row seat with switch



1. Left/right headrest adjustment switch
 - Adjustment of headrest height at corresponding side: Press the front/rear part of the switch.
2. Backrest angle adjustment switch
 - Adjustment of the backrest angle: Press and hold the front/rear part of the switch.

Tips

Use this switch to fold/recover the backrest.

3. Middle headrest adjustment switch

- Adjustment of middle headrest height: Press and hold the front/rear part of the switch.



4. One-tap folding, flipping and storage switch

- One-tap folding: Press the left/right switch to allow the second-row seats to move



forward, lower the headrest of the third-row seats to the lowest position and fold the backrest.

- One-tap recovery: Pull the left/right switch for a short time to allow the second-row seats move forward, reset the backrest gradually, and then return third-row seat headrest to its original position.
- Flipping and storage: Press and hold the left/right switch for at least 2s to flip and store the third-row seat into the trunk.
- Seat recovery: Pull up the left/right switch at the same time for at least 2s, and then the third-row seats will return to their seating positions.

caution

- Certain conditions shall be met for one-tap folding, flipping and storage functions. For example, the vehicle is in P position; the third-row seat is unoccupied; seats have been initialized; second-row seats are

properly positioned; the third-row seat belts are not fastened.

- Only when the second-row seats are unoccupied will they move forward automatically to meet the space requirements for one-tap folding, flipping and storage functions.
- In order to avoid damage to the seat, it is necessary to remove the articles in the trunk before flipping and storage. If any obstacle is detected during flipping and storage, the seat will stop moving.



CID seat adjustment

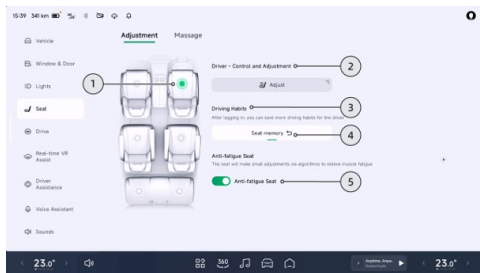

On the “**Seat**→**Adjustment**” interface of the CID, adjust the seat position.

1. Tap to select the seat to be adjusted.
2. Tap to enter the adjustment interface of the selected seat.

Tips

Depending on the vehicle configuration, the second/third-row seats are provided

with switches such as Easy Entry/Exit, zero gravity mode, and flipping for storage

3. After logging in, enter the Driving Habits management interface to add Driving Habits or rename the habits.
4. Tap to recall the memory position of the selected seat.

Tips

- This is the driver's driving habit, which can be tapped to call the memory positions of the driver's seat and rearview mirror at the same time.
 - When selecting a seat other than the driver's seat, press and hold it to rename the memory position.
5. Tap to turn on/off the “**Anti-fatigue Seat**”.

- The dynamic algorithm is used in conjunction with minor adjustment of seat to relieve muscle fatigue.



Seat position memory

1. Select front-row or second-row seats on the Seat - Adjustment interface of the CID.
2. Adjust the seat to a proper position.
3. Save according to CID prompts.

Seat anti-pinch

caution

Even if the seat has anti-pinch function, make sure that there is no person or article obstructing the seat or within track movement range before adjustment; otherwise, personal injury or vehicle damage may be caused.

The anti-pinch function will be activated if the resistance is too great during the following operations:

- Adjust the driver's/front passenger's seat forward and backward, and adjust the backrest backward.

- Adjust the second-row seats forward and backward, backrest backward and leg support angle (excluding the length of leg support).
- Adjust the backrest angle of third-row seat, and fold and flip the backrest for storage.

Tips

- After the cushion and floor are unlocked, the third-row seat will stop moving when the anti-pinch function is activated at the beginning and end of folding/storage.
- When the anti-pinch function is triggered by the driver's/front passenger's seat and second-row seats, these seats will stop moving and return for a certain distance. When the anti-pinch function is triggered by the third-row seats, these seats will stop moving.

Seat initialization

Initialization of driver's/front passenger's seats and second-row seats



1. Pull the backrest angle adjustment switch forward, and release it after the backrest moves to the foremost position and stops.
2. Move the switch forward again to confirm that it is in the foremost position, and then release the switch.
3. Toggle the switch forward again within 5s, and hold switch for more than 5s until the seat starts automatic initialization.
4. Wait until the seat stops completely before using it.

Initialization of third-row seat

1. Press the front part of the backrest angle adjustment switch on the left side of the third-row seat, and release the switch after the backrest is folded completely and stops.
2. Press the front part of the switch again, and release it when it is confirmed that the backrest is fully folded.
3. Press the switch again within 5s, and hold switch for more than 5s until the seat starts automatic initialization.

4. Wait until the seat stops completely before using it.

caution

- During initialization, the seat will automatically move to the limit position in all directions. Please adjust the front and rear seats to the forward/backward positions before initialization to leave enough movement space for the seat to be initialized and avoid bumping.
- Press the seat switch (including CID) during initialization, and the initialization will be suspended.
- The driver's/front passenger's seats and the second-row seats are initialized separately, and the third-row seats are initialized as a whole (by operating the left backrest angle adjustment switch).



Warnings, cautions and limitations

warning

- Excessively large angle of the third-row backrest may cause safety hazards during driving, therefore, do not adjust the backrest too backward.
- Be careful when adjusting the seat to ensure that other passengers will not be injured when the seat moves.
- The headrest cannot be used when it is in the lowest position. Do not adjust it to this position when the seat is occupied.
- Do not put fingers or other parts of the body under the seat; otherwise, they may be pinched by the seat.
- Do not adjust the driver's seat when the vehicle is running, because the driver may deviate from the correct sitting posture, which can cause casualties easily.
- Do not adjust the seat when seat belt is fastened, to prevent the seat belts from

being out of normal use state, causing personal injury or protection failure.

caution

Do not place excessively thick foot mats or other foreign objects (such as drink bottles, carbon bags, etc.) at the bottom of the driver's/front passenger's seat or second-row seats; otherwise, they may be sandwiched between the seat and the guide rail, hindering the adjustment and locking of the seat, thus damaging the seat. It is recommended to use the floor mats officially certified by XPENG.

Exterior rearview mirror

Introduction

Exterior rearview mirror supports the following functions:

- Adjust the mirror angle using the steering wheel scroll button and button.
- Mirror angle memory

Driving operation



- Automatic tilting-down of mirror in reversing
- Automatic folding/unfolding of exterior rearview mirror
- Manual folding/unfolding of exterior rearview mirror

Operation

Open the exterior rearview mirror adjustment interface in any of the following ways:

- X-Peng voice
- Shortcut panel of CID [See 25 page](#)
- The CID bottom status bar (if set [See 24 page](#), only supports folding or unfolding of the exterior rearview mirror)
- Tap “ **Drive** → **Exterior Side Mirrors**” in turn on the CID.

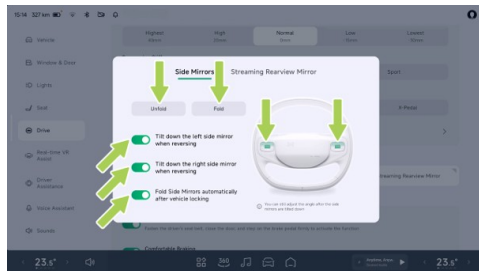

Adjust the mirror angle using the steering wheel scroll button and button

After opening the adjustment interface, adjust the angle of the exterior rearview mirror with the scroll buttons on both sides of the steering wheel and the left/right button.

caution

- Exterior rearview mirror will jump after being adjusted to the limit position, which is normal. Continuous adjustment in this



direction may lead to damage to the rearview mirror.

- Do not manually press the rearview mirror to adjust the tilt angle.

warning

- Do not adjust the exterior rearview mirror during driving to prevent accidents.
- Do not refit the exterior rearview mirror without permission.

Mirror position memory

Exterior rearview mirror angle after adjustment will be automatically saved to the current driving habits.

Automatic tilting-down in reversing

The function of “**Tilt down the left/right side mirror when reversing**” can be enabled. When the vehicle is in P position, exterior rearview mirror at corresponding side will automatically tilt down to assist reversing.

Automatic-folding of exterior rearview mirror while the vehicle is locked

Unfolding: Exterior rearview mirror will unfold automatically when the vehicle is unlocked.

Folding: Exterior rearview mirror will fold automatically when the vehicle is locked.

Tips

Exterior rearview mirror will fold automatically when parking function such as straight-line calling is enabled.

Manual unfolding/folding of exterior rearview mirror

Exterior rearview mirror can be unfolded/folded manually on exterior rearview mirror adjustment interface or shortcut panel of the CID.

Exterior rearview mirror reset

Exterior rearview mirror may be folded forward or backward due to accidental impact or manual pushing. It can be restored to the normal position with the following method.



1. Tap “**Unfold**” until the exterior rearview mirror is unfolded.
2. Manually push the exterior rearview mirror to normal position.

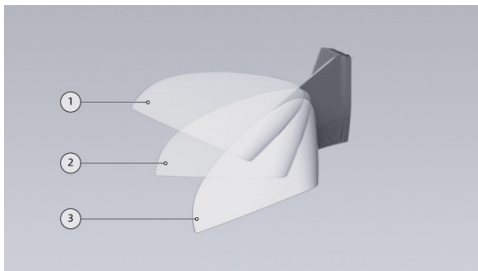

1. Forward folding
2. Standard state
3. Backward folding

i Tips

Before manual reset, check the folding surface for foreign objects such as ice and snow, and remove them (if any). Otherwise, the

exterior rearview mirror folding structure may be damaged.

Light adjustment

Introduction

You can control lights by the following means:

- Left lever
 - Shortcut panel (only supports automatic headlight on/off) [See 25 page](#)
 - Setting interface
 - Bottom status bar (if set [See 24 page](#), only supports rear fog light on/off and automatic high beam on/off)
- X-Peng voice

i Tips

The high beam cannot be turned on by X-Peng voice.



Operation

Left lever

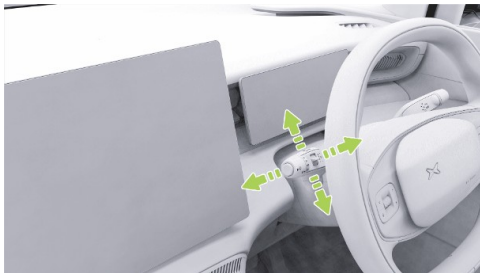

- Turn signal: Pull the lever upward/downward gently, and it will return to the original position automatically after being released, in which case the turn signal on the corresponding side will flash 3 times.
- Turn signal: Push the lever upward/downward again, and the turn signal on the corresponding side will flash. When the lever is pushed to the turn signal position or the

steering wheel returns to its original position, the turn signal will be off.

- High beam: When the low beam is on, pull the lever forward to turn on the high beam; push it again to turn off the high beam.
- Overtaking light: With the low beam turned on, pull the lever backward continuously and release it, and the high beam will flash.

CID setting interface

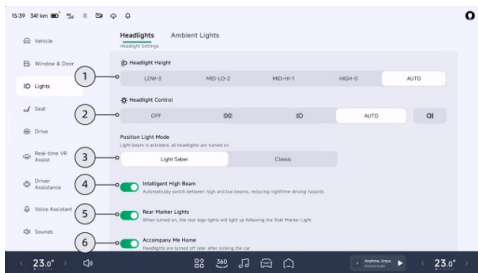

1. Headlight height:



- LOW-3: Only the driver's seat is occupied, and there are about 300 kg of luggage in the trunk.
- MID-LO-2: The vehicle is fully occupied or the vehicle is fully occupied and there are about 60 kg of luggage in the trunk.
- MID-HI-1: Front-row and third-row seats are occupied.
- HIGH-0: Only the driver's seat is occupied or only the driver's seat and front passenger's seat are occupied.
- AUTO: Adjust the headlight height automatically according to the load.

2. Headlight control:

- Off: Tap it to turn off all exterior lights.
- : Tap it to turn on/off the clearance light and license plate light.
- : Tap it to turn on/off the low beam.

caution

When the vehicle is running in a dark environment, it is necessary to confirm twice on CID before turning off the low beam.

- Automatic: The low beam is turned on/off automatically according to the ambient brightness of the vehicle.

Tips

You can also turn on/off automatic headlights on the CID shortcut panel.

- : Tap it to turn on/off the rear fog lights. If the low beams do not illuminate, they will be turned on simultaneously.
3. Clearance light mode: Tap "**Light Saber**" or "**Classic**" mode.
 4. Intelligent high beam: Tap to turn on/off the intelligent high beam [See 282 page](#).
 5. Rear logo light: The rear logo light will be on along with the clearance light.



6. Follow Me Home:

- After it is turned on, when the ambient brightness around the vehicle is low, "Accompany Me Home" function will be activated. The headlight can be set to go out after a delay of "15s", "30s" and "60s".

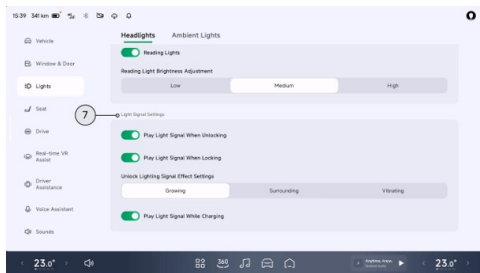

7. Light signal setting:

- You can turn on/off "Play Light Signal When Unlocking".
- You can turn on/off "Play Light Signal When Locking".

- Set the light signal of unlocking/locking.
- You can turn on/off "Play Light Signal While Charging".

Daytime running light

When the vehicle is in "READY" state and not in P position, and high and low beams are turned off, the daytime running light will be on.

Steering auxiliary light

With the low beam on, the corresponding steering auxiliary light will be turned on to increase the illumination on the inner side of the curve when the vehicle turns at a low speed (less than 40 km/h, and steering wheel angle is greater than 30°); the steering auxiliary light will gradually go out after being on for 2s when the steering wheel returns to center.

Wiper control

Introduction

The wiper can be controlled by the left lever.



Operation

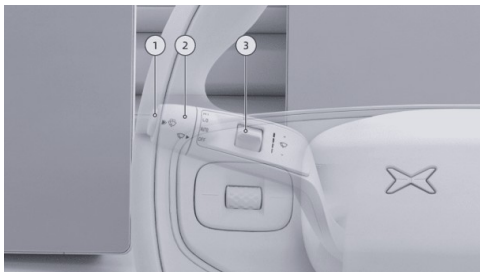

1. Washer switch
 - Press: Wipe once.
 - Press and hold: Front washer sprays water and front wiper works.
2. Front wiper switch
 - OFF: Stop wiping.
 - AUTO: Wipe based on the rainfall.
 - LO: Wipe at low speed.
 - HI: Wipe at high speed.

3. Wiper sensitivity switch

i Tips

You can set the automatic wiper sensitivity through the wiper sensitivity switch or on the “🚗→Window & Door” interface of CID.

Gearshift control

Introduction

Shift gears using the lever on the right of steering wheel.

Operation

⚠ caution

Please shift gears when the vehicle stops completely.

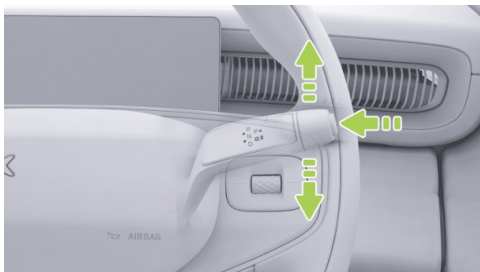

R: Reverse gear

Press the brake pedal and push the gearshift lever upward for two gears at the same time to shift to R position, in which case the backup light turns on.

N: Neutral

The vehicle can be shifted to N position by the following operations:

- With the vehicle in D position, press the brake pedal, and push the gearshift lever upward for one gear and hold it for 1s.

- With the vehicle in the R position, press the brake pedal, and push the gearshift lever downward for one gear and hold it for 1s.
- With the vehicle in P position, press the brake pedal, and push the gearshift lever upward or downward for one gear and hold it for 1s.

D: Drive

Press the brake pedal and push the gearshift lever downward for two gears to shift to D position.

P: Park gear

Press the brake pedal, and press P-position switch on the gearshift lever to shift to P position.

i Tips

- After gear shifting, the corresponding gear indicator on the instrument will be black.
- The vehicle will shift to P position automatically when the driver's door is opened with the gearshift lever in D or R



position at a speed less than 3 km/h, seat belts not fastened, and brake pedal and accelerator pedal not pressed.

- When the conditions for gear shifting are not met, the instrument will give a text prompt. Please operate according to the prompt and shift gears after the conditions are met.

Warnings, cautions and limitations

caution

- Before leaving the vehicle or on a ramp, make sure that the gearshift lever is in P position to prevent unexpected movement of the vehicle.
- If the gear cannot be shifted normally, please contact the XPENG Service Center for maintenance in time.

Braking control

Operation

On the “→Drive” interface of the CID, you can set the braking function.

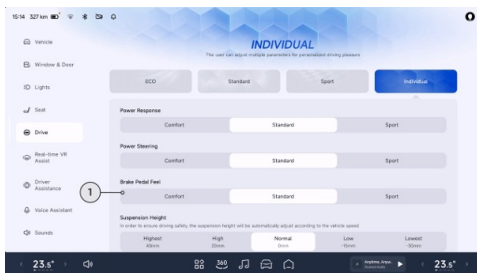

1. Select an appropriate brake pedal feel according to personal preference.
 - Comfort: The braking force response is smooth and the riding experience is more comfortable.



- Standard: The braking force response is moderate, and the driving pleasure and riding comfort are also ensured.

Tips

Standard pedal force and depressing travel, suitable for most drivers.

- Sport: The braking force response is fast, and the driving control is more flexible.

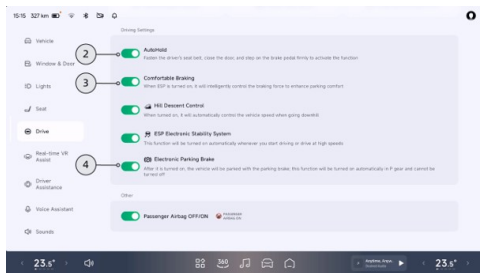

2. You can turn on/off “**AutoHold**”.

- If you need to stop the vehicle for a short time, you can activate AUTO HOLD and release the brake pedal. The system will apply brake automatically and keep the vehicle stationary.
- Function activation: After the vehicle stops, press the brake pedal hard. The indicator will illuminate on the instrument panel, and AUTO HOLD is activated. At this time, you can release the brake pedal.

Tips

Close the driver's door, fasten the seat belts. AUTO HOLD can only be activated when the gearshift lever is in D/R/N position.

- Function deactivation: After AUTO HOLD is activated, press the accelerator pedal to deactivate AUTO HOLD.

Tips

- With AUTO HOLD activated, opening the driver's door or unfastening the





seat belts will make the vehicle switch to EPB automatically.

- After AUTO HOLD is maintained for a period of time, the vehicle will be switched to EPB.

caution

AUTO HOLD cannot go beyond the kinematics rules. Please enable AUTO HOLD according to the road conditions.

3. You can turn on/off “**Comfortable Braking**”.
 - After it is turned on, the system will control the braking force intelligently to improve the braking comfort.
4. You can turn on/off “**Electronic Parking Brake**” (EPB).
 - When the vehicle is stationary, turn on “**Electronic Parking Brake**” or press the P position switch to illuminate the  indicator on the instrument panel, and the EPB is activated successfully.

- When the vehicle is stationary, apply the brake pedal or press the brake pedal to disable the “**Electronic Parking Brake**” or shift to D/R position. At this moment, the  indicator goes out on the instrument panel and the EPB is disabled successfully.

Tips

- When the vehicle is in P position, you cannot turn off the EPB by turning off the “**Electronic Parking Brake**”.
- When the EPB is turned on/off, the system will produce running noise, which is normal.
- Under special circumstances, pressing and holding the P position switch can activate the EPB function.

caution

- If the EPB cannot be turned on/off normally, contact a XPENG Service Center for maintenance immediately.



- If the vehicle cannot be powered on due to undervoltage battery, and the EPB cannot be turned off, please perform jump start or contact the XPENG Service Center for assistance.
- Do not drive the vehicle without turning off the EPB; otherwise, it is easy to damage the EPB.

Driving modes

Introduction

You can select the driving mode by the following means:

- X-Peng voice
- CID
 - Bottom taskbar (if set)
 - Setting interface

Operation

CID setting interface

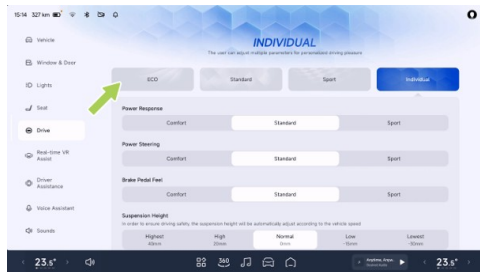

On the “→Drive” interface of the CID, you can select the driving mode according to your preferences.

- ECO: The dynamic response is gentle, and the riding experience is more comfortable.
- Standard: The dynamic response is moderate, and the driving range and driving performance are also ensured, which is suitable for most roads.
- Sport: The dynamic response is fast, and super driving pleasure is provided.



- Individual: Multiple functional parameters can be adjusted freely and personalized driving pleasure can be enjoyed.

i Tips

When setting the driving mode, set the air suspension stiffness synchronously .

Rear-wheel steering

Introduction

The maximum rear wheel steering angle of the vehicle can reach $\pm 5^\circ$. When the vehicle runs at a high speed, the rear wheels and front wheels deflect in the same direction to improve steering directivity and vehicle stability. When the vehicle runs at a medium or low speed, the rear wheels and front wheels deflect in different directions to improve vehicle flexibility, achieve a smaller turning radius, and make it easier to control parking or urban conditions.

i Tips

- If the vehicle cannot move after being powered on, turn the steering wheel in situ to check whether the rear wheels can turn.
- After the vehicle is powered on and driven, brake to stop it, with the gearshift lever in D/R position. Turn the steering wheel in situ to turn the rear wheels. Avoid turning too much in situ as far as possible; otherwise, overtemperature protection will be triggered.
- In case of overtemperature protection, the rear wheel steering gear returns to the center automatically and stops responding. The vehicle can run normally, and control can be restored automatically after 6 minutes.
- The instrument will give a prompt when the overtemperature protection is triggered.



Air suspension

Introduction

The air suspension supports the following operations:

- Height setting
- Stiffness setting
- Easy loading
- Suspension greeting [See 170 page](#)

Operation

Height setting

The air suspension height can be adjusted within the range of -50~40 mm by the vehicle during driving according to the height set by the driver and in combination with information such as vehicle speed and driving mode.

Height Gear	Suspension height	Recommended Application Scenarios
-------------	-------------------	-----------------------------------

Maximum	+40 mm	Poor non-paved roads such as bumpy roads, gravel roads and muddy roads
Higher	+20 mm	
Normal	0 mm	Daily Driving
Low	-15 mm	High-speed sections such as viaducts and expressways
Minimum, welcome mode	-30 mm	When getting on and off the vehicle
Easy loading	-50 mm	When loading luggage in the trunk

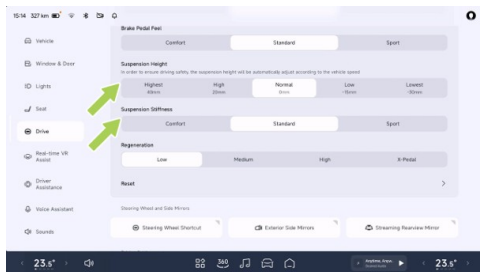

On the “**Drive**” interface of the CID, you can set the suspension height and suspension stiffness.

i Tips

- If the suspension height is adjusted frequently for several times, the system will enter the thermal protection state. The adjustment can be continued only after the system cools down.
- The suspension height can also be adjusted by X-Peng voice.

Stiffness setting

The air suspension stiffness is associated with the driving mode [See 273 page](#), and lateral stiffness can be increased at high-speed turning to prevent tilting.

Driving modes	Suspension stiffness	Stiffness Switching Time	Recommended Application Scenarios
Comfort	Soft	Conservative	Suitable for rural roads, paved roads and broken roads
Standard	Moderate	Moderate	Daily city driving, commuting



Driving operation

Sport	Relatively hard	Aggressive	Suitable for high-speed cruise, urban expressway and mountain road
-------	-----------------	------------	--

i Tips



In the process of restraining the body pitch angle and steering body roll/roll during acceleration and deceleration, the air suspension will make a “click” sound, which is the normal working sound of the dual-chamber air valve.

Easy loading

You can turn on/off the easy loading function manually through the easy load switch in the trunk, or by tapping “**Auto Easy Loading**” on the

CID. The suspension is adjusted to the lowest position when the trunk is opened.





By pressing the  button, the button indicator lights up and the suspension descends to the lowest position. By pressing the  button, the button indicator lights up and the suspension restores to the previous height.

On the “→**Window & Door**” interface of the CID, you can turn on/off “**Auto Easy Loading**”.



Warnings, cautions and limitations

caution

- When lifting the vehicle, the suspension maintenance mode must be activated, and during towing, the rescue mode must be enabled, otherwise, the air suspension may be damaged.
- The air suspension must be removed and installed at the XPENG Service Center; otherwise, the air suspension may be damaged.
- If the  and  indicators illuminate on the instrument panel, do not drive continuously, park the vehicle in a safe area and contact the XPENG Service Center for maintenance; otherwise, the air suspension may be damaged.
- After the vehicle is parked for a long time, the suspension height will drop to a certain extent, which is normal. The suspension will detect the height automatically and replenish air.

- Before parking the vehicle for a long time, please disable the suspension greeting and easy loading functions, adjust the suspension to a normal or greater height, and do not cut off the battery; otherwise, the air supplement function of the suspension will be affected, resulting in damage to the vehicle

On the “Vehicle” interface of the CID, you can turn on/off “**Suspension Maintenance Mode**”.

Energy recovery

Introduction

When the vehicle coasts or brakes, the energy recovery function can convert part of the kinetic energy into electric energy to charge the traction battery and increase the driving range.

Energy recovery can be set in the following ways:

- X-Peng voice
- CID setting interface



Operation

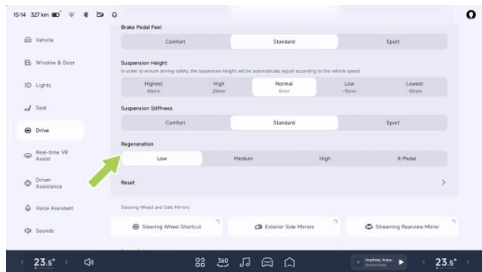

On the “**Drive**” interface of the CID, you can set different energy recovery levels.

Factors affecting energy recovery

The amount of power supplied to the traction battery through energy recovery depends on the following factors:

1. Current state of the traction battery.
 - Traction battery SOC.

- Traction battery temperature.
2. The energy recovery level selected.

Warnings, cautions and limitations

Tips

- Different energy recovery levels correspond to different driving experiences.
- If energy recovery braking significantly reduces the vehicle speed (for example, when driving on a steep slope), the brake light will illuminate to remind the driver of the vehicle behind that you are decelerating.

warning

- If the braking effect of energy recovery cannot ensure safe driving, the driver shall apply brake to the vehicle in time according to the actual situation.
- Selecting X-Pedal (single pedal mode) can reduce the use of brake pedal, further recover kinetic energy and increase the driving range, but it cannot completely

Driving operation



replace the brake pedal. In order to prevent the vehicle from sliding on a ramp, it is necessary to press the brake pedal when the vehicle is close to stop. If necessary, press the brake pedal hard to start AUTO HOLD.

Power steering

Introduction

You can set the steering assist mode by the following means:

- X-Peng voice
- CID setting interface

Operation

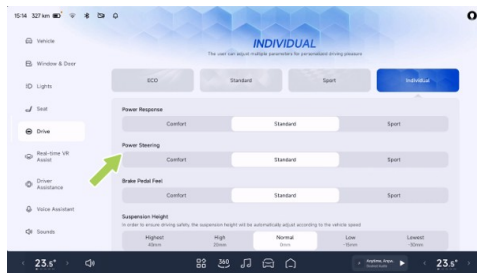

On the “→Drive” interface of the CID, you can select “**Comfort, Standard, Sport**” in “**Power Steering**”.

- **Comfort**: The steering force is the minimum, and it is recommended for comfortable driving.
- **Standard**: The steering force is moderate, and it is recommended for general driving.
- **Sport**: The steering force is relatively heavy, and it is recommended for sport driving.



warning

It is not recommended to adjust the steering assist mode during driving.

Use anti-skid chains

Introduction

When driving in severe environments such as snowy or icy roads in winter, tire chains can be used to increase tire friction and reduce sideslip. To use tire chains, the following suggestions must be followed:

- It is necessary to install tire chains when driving in deep snow. The vehicle is not equipped with tire chains, which can be purchased as needed. The size and type of tire chains selected must conform to the tire specifications on the vehicle.

The dimensions and specifications of rims and tires suitable for installing tire chains are as follows:

Rim size	Tire size
20-inch rim	235/50 R20

- Install tire chains on the tire to ensure balanced driving in all kinds of weather. Keep in mind that the vehicle power may be insufficient after tire chains are installed. Drive carefully even if the road is in good condition. During driving, do not exceed the specified speed limit of tire chains or 50 km/h, whichever is smaller.
- Tire chains can only be installed on the front wheels. Tire chains shall be installed in pairs. Self-tensioning tire chains are not allowed.
- Do not use tire chains on dry ground. Remove tire chains once road surfaces are free from ice or snow.
- Install the tire chains as close to the tire as possible, and tighten them again after driving for 0.5~1.0 km.
- If the vehicle is equipped with wheel trim cover, remove it before installing tire chains.



- If you hear friction or crash sound between the tire chains and the vehicle during driving, stop the vehicle and re-tighten the tire chains. If this does not work, remove the tire chains to prevent damage to the vehicle.

Intelligent High Beam (IHB)

Introduction

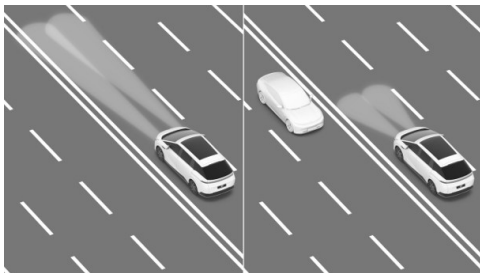

The IHB can automatically switch between high and low beams according to the conditions of

vehicles ahead and ambient lighting, to avoid affecting surrounding traffic participants.

Instrument indicators



The IHB is enabled and the high beam is not on.



The IHB is enabled and the high beam is on.



The IHB has a fault.

Operation

Opening and closing

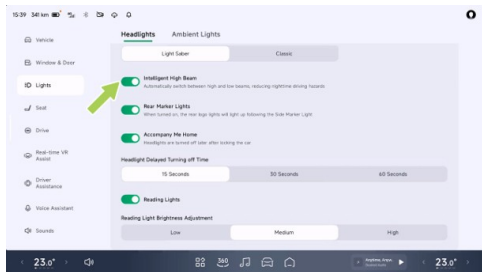

On the “**☰→Lights→Headlights**” interface of the CID, you can turn on/off “**Intelligent High Beam**”.

Use of IHB

When the following conditions are met at the same time, the IHB is activated and the vehicle automatically switches between high beam and low beam according to the road environment:

- The CID light switch is in the AUTO position.
- The vehicle speed is greater than 30 km/h.

i Tips

When IHB is active, if the vehicle speed is less than 15 km/h, IHB will exit.

Warnings, cautions and limitations

⚠ warning

IHB is only a convenience feature with certain limitations. The driver is responsible for ensuring that the headlights are properly adjusted at all times when driving in various weather conditions and situations.

The IHB may not work properly in the following scenarios:

- Bad weather;
- Excessive reflective environment;
- Camera limited.

The above warnings, cautions and limitations do not cover all conditions that may affect the normal operation of IHB.



Low-temperature battery preheating

Introduction

Low-temperature battery preheating can improve the driving range of the vehicle in a cold environment. It is recommended to activate preheating 1 hour before departure.

You can enable/disable the low-temperature battery preheating function by the following means:

- CID setting interface
- Mobile App Bluetooth key [See 168 page](#)

Operation

CID setting interface

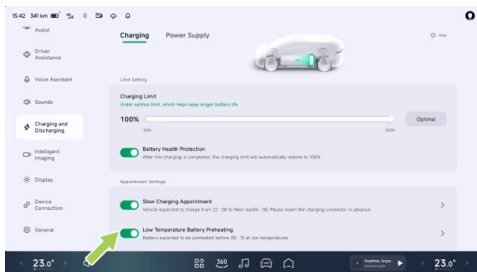

On the “→**Charging and Discharging**→**Charging**” interface of the CID, you can set the preheating start time.

caution

- If it fails to start, please check whether the enabling conditions of the function are met. In case of an abnormal situation, please contact the XPENG Service Center.



- In the low-temperature battery preheating mode, insert the charging gun and lock the vehicle to prevent others from removing the charging gun.

Warnings, cautions and limitations

i Tips

- When charging at a low ambient temperature, the system will preferentially heat the traction battery. After the temperature of the traction battery becomes normal, normal charging will start. Therefore, the charging time will be slightly longer than that in usual.
- After the traction battery is preheated, it is recommended to start the vehicle as soon as possible. Long-term parking will reduce the heating effect.
- If scheduled slow charging is adopted at the same time, please make sure that the set preheating time is later than the scheduled charging time.

- If the traction battery temperature is high, the low-temperature battery preheating function will not be enabled.
- Low-temperature battery preheating will slightly increase the power consumption of the charging pile. Please use it as needed.

Steering wheel adjustment

Operation



1. Pull the steering wheel unlocking handle downward to unlock the steering wheel.



2. Move the steering wheel vertically and horizontally to a proper position.
3. Pull the steering wheel unlocking handle upward to lock the steering wheel.

warning

- It is not allowed to adjust the steering wheel position during driving.
- Adjusting steering wheel to an improper position may cause personal injury. The minimum distance between steering wheel and the driver's chest shall be 25 cm.

Streaming interior rearview mirror

Introduction

The streaming interior rearview mirror can function as ordinary mirror and display screen. After switching to the streaming mode, the image behind the vehicle will be displayed on the mirror in real time to increase the visible range of the interior rearview mirror.

The streaming interior rearview mirror supports the following functions:

- Switching between streaming mode/ordinary mirror:
 - Streaming interior rearview mirror switch
 - CID setting interface
 - Infotainment screen on/off [See 187 page](#)
 - X-Peng voice
- Adjustment of view with steering wheel scroll button
- Automatic adjustment of view at high speed
- Automatic adjustment of view during reversing
- Screen brightness regulation

Operation

Switching between streaming mode/ordinary mirror

Streaming interior rearview mirror switch



Press this button to switch from the streaming mode to ordinary mirror mode. Press the button again to switch to streaming mode.

CID setting interface

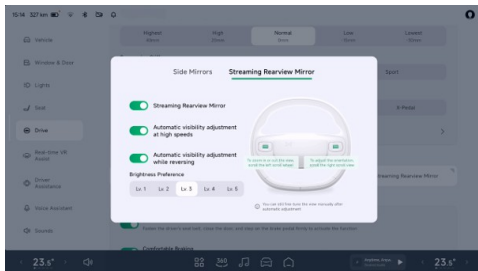

Open the streaming interior rearview mirror adjustment interface by any of the following means:

- X-Peng voice.
- The “**side Mirror Adjustment**→**Streaming Rearview Mirror**” on the shortcut panel.
- Tap “**Drive**→**Streaming Rearview Mirror**” on the CID.

On this interface, turn on the streaming interior rearview mirror to switch to the streaming mode,



and disable the function to switch to the ordinary mirror mode.

Use of steering wheel scroll button to zoom in/out or adjust upper/lower position of the field of view

On this interface, roll the left scroll button to zoom in or out the field of view, and roll the right scroll button to adjust the upper and lower positions of the field of view.

i Tips

After the automatic view adjustment is turned on during reversing, the view can still be adjusted manually.

Automatic adjustment of view at high speed

After the function is activated, when the gearshift lever is in D position and the vehicle speed is higher than 80 km/h for a period of time (more than 10s), the field of view of the streaming interior rearview mirror will be adjusted automatically. When the gearshift lever is not in D position or the vehicle speed is less than or

equal to 60 km/h for a period of time (more than 10s), the field of view of the streaming interior rearview mirror will return to the default value.

Automatic adjustment of view during reversing

After the function is activated, when the gearshift lever is in R position, the field of view of the streaming interior rearview mirror will be adjusted automatically. When the gearshift lever is not in R position, the field of view of the streaming interior rearview mirror will return to the default value.

Screen brightness regulation

In the “**Brightness Preference**”, you can select “**Lv.1, Lv.2, Lv.3, Lv.4, Lv.5**” according to the environmental condition.

i Tips

- The brightness of the screen is automatically adjusted according to ambient light.



- After each power-on, the streaming interior rearview mirror will return to the status of the last memory.

Warnings, cautions and limitations

warning

Do not use the streaming interior rearview mirror in the following scenarios:

- Camera limited .
- Unfavorable climatic conditions (such as heavy rain, snow and fog).



Electric charging port cover

Introduction

You can open/close the charging port cover by the following means:

- Charging port cover switch
- Smart remote key [See 164 page](#)
- X-Peng voice
- CID
 - 3D Vehicle Control [See 55 page](#)
 - Shortcut panel [See 25 page](#)
 - Bottom status bar (if set) [See 24 page](#)
 - Setting interface
- Mobile App Bluetooth key [See 168 page](#)
- Automatic closing

i Tips

Charging port cover cannot be opened with the right Slide door open.

! caution

- After charging is completed, please close the dust cover in time to prevent water from entering the charging port or damaging the charging port cover and the dust cover.
- Do not close the charging port cover by pressing the cover plate to avoid damaging the charging port cover.

Operation

Charging port cover switch





Charging instructions

The charging port cover can be opened by unlocking the vehicle or carrying the key and pressing the upper left area of charging port cover.

Tips

The charging port cover can be opened only if the phone key is close to the locked vehicle for automatic unlocking.

caution

During vehicle washing, avoid using high-pressure water jets to impact the switch area of the charging port cover; otherwise, the charging port cover may be opened.



Charging port cover can be closed by pressing the switch.

caution

After charging, please put the dust cover back to the charging port to prevent foreign objects from falling in.



CID setting interface

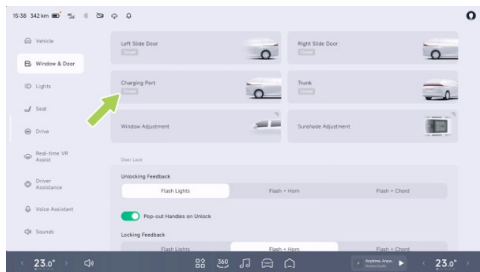

On the “**Window & Door**” interface of the CID, you can turn on/off the “**Charging Port**”.

Automatic closing

Charging port cover will be closed automatically when any of the following conditions is met:

- Pull out the charging gun and lock the vehicle.
- No operation after a period of time, with the charging gun not plugged in.
- After the gearshift lever is not in P position.

Charging operation

Introduction

A charging pile meeting relevant standards can be used to charge the vehicle.

Operation

Charging work procedure

1. Park the vehicle and shift the vehicle into Park (P).
2. Open the charging port cover
3. Remove the charge port dust cover.



Charging instructions



4. Remove the charger gun protective cap and insert the charger gun straight into place, keeping the charging harness loose and hanging naturally.
5. After following the instructions of the charging pile (swipe card or code), start charging.

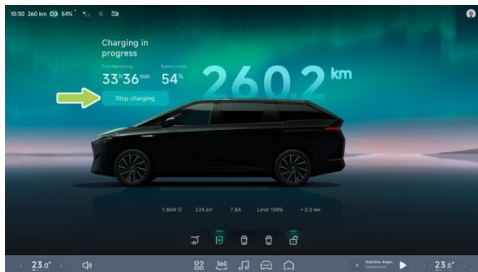

6. If you need to temporarily end the charging process. Click the **“End Charging”** button on the CID. End the charging and confirm at the charging screen that the charging has ended.

hazard

Removing the charge gun directly while the vehicle is charging may cause personal injury. After the vehicle has finished charging and the CID exits the 'charging/heating up' status display, Only use the emergency unlock pull ring to unlock the charge gun.

Charging instructions



7. When charging is complete, remove the charge gun.
8. Close the charging port dust cover and close the charging port cover.
9. Put the charge gun back into the home position of the charge post.

warning

- The vehicle may affect medical or implantable electronic devices when charging and discharging, consult the electronic device manufacturer before charging and discharging.
- If a fault occurs during charging, the charging screen will pop up a fault indication, do not try charging again, contact the XPENG Automobile Service Centre immediately.

caution

- If the gun fails to pull out, the gun can be unlocked using either the CID emergency

unlock switch or the boot emergency unlock pull ring.

- Charging or stopping must be done in strict accordance with the operating procedures of the charging pile. Do not plug or unplug the charge gun during charging.

Tips

- The system heats the power battery and automatically enters charging when the specified state is reached.
- When charging a cold ambient gun, there may be situations where the charging efficiency is reduced or the charging is not possible. When the power battery is discharged and charged in a cold environment, the system heats the power battery to the appropriate temperature when the charge gun is connected before charging the power battery.
- Before fast charging in a low-temperature environment, it is recommended to use the



Charging instructions

temperature control function before fast charging.

- The charging time may vary depending on factors such as outside temperature, battery life or charging current.

Emergency unlocking of charging gun

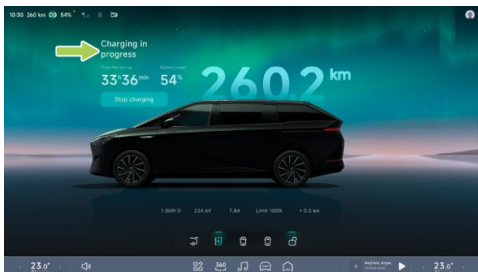

When the vehicle is charging, the message 'Charging/Heating Up' is displayed on the CID, do not pull the gun at this time, as personal injury may result. To end charging early, You must first click on "End Charging" in the CID. The

charge gun cannot be removed until the switch is switched on and the central control screen exits the "Charging/Heating" status display.

In the event of a sudden condition (e.g. a faulty charging pile, a faulty electronic lock), which prevents the AC charge gun from being pulled out, the emergency unlock switch or the emergency unlock tab of the boot can be used. Remove the charge gun after unlocking the charge gun lock.

CID emergency unlock switch

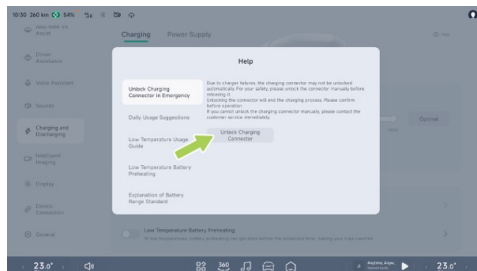

Charging instructions



On CID , find the “”
→**Unlock ChargingConnector in Emergency**→**help**”interface, Tap“**unlock charging connector**”to manually unlock the charge gun and pull it. If charging is in progress, unlocking the charge gun will end charging early, please confirm and proceed.

Tips

When the charging flap is closed, the 'Unlock Charging Gun' button does not appear on the central control screen.

Trunk emergency unlock pull ring

If the charger gun still fails to pull out after several attempts at the emergency unlock key of the central control screen, pull the charger gun out by plugging it into place as follows:

1. Open the rear trunk and use a suitable tool to open the rear trunk service cover.



2. Locate the emergency unlock ring of the charging port, pull the ring, unlock and pull out the gun.

caution

- After the vehicle has finished charging and the CID exits the 'charging/heating up' status display. Only use the emergency unlock pull ring to unlock the charge gun.
- The emergency unlocking of the ring by the charging port is suitable for use in emergency situations and frequent use may



damage the emergency unlocking ring or the charging device.

- If you cannot unlock the charge gun using the emergency unlock ring of the charging port, please contact the XPENG Service Center in a timely manner.

Warnings, cautions and limitations

- When taking out the charging gun from the charging pile, please hold it tightly with both hands to prevent the twisted charging cable from rebounding and hitting personnel, causing personal injury.
- Before charging, check whether the charging port, charging gun, and charging plug are dry. Do not operate the charging equipment if it or your hands are wet.
- The charging cable must be laid out smoothly during charging and must not be twisted.
- If the charging equipment shows signs of corrosion or damage, such as deformed or skewed charging gun metal terminals, or cracked or deformed plastic plug components, charging is prohibited.
- In case of an emergency during charging, press the emergency stop button on the charging equipment to stop charging.
- During thunderstorms, it is recommended to stop charging the vehicle, as lightning may damage the charging equipment.
- It is advised to choose shaded charging stations with rain shelters to avoid rain or snow splashing into the charging port when plugging or unplugging the charging gun.
- When plugging or unplugging the charging gun, unlock the vehicle and pull or insert the charging gun vertically. Do not insert at an angle or shake it.
- If the charging port emits a strong, pungent smell during charging, immediately stop charging.
- Children must not touch or use the charging equipment.



- If dust, large particles, or hard foreign objects are found in the charging socket, charging gun, or charging plug, clean it after the vehicle is powered off before proceeding with charging.
- If you have an implanted pacemaker, cardioverter defibrillator, pain pump, insulin pump, hearing aid, or other electronic medical devices, do not stay inside the vehicle or enter the vehicle to retrieve items while charging, as this may interfere with electronic medical devices and cause personal injury or death.
- Do not dismantle or modify the charging port or charging cable.
- After charging, please cover the charging port with the dust cover promptly and close the charging port cover to prevent rain, snow, or other foreign objects from entering.
- Due to variations in understanding of charging standards among charging pile manufacturers and differences in maintenance quality of charging pile products, some charging piles may fail to charge the vehicle successfully. If such an issue occurs, try reinserting the

charging gun or switching to another charging pile.

Charging limit

Operation

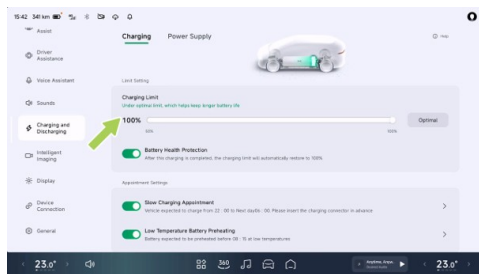

On the “→Charging and Discharging→Charging” interface of the CID, you can set “Charging Limit”, and the charging will automatically end when the set limit is reached.



i Tips

- If Battery “**Health Protection**” is turned on, the charging limit will reset to its default value after the vehicle is powered on again. For vehicles equipped with ternary lithium batteries, the charging limit defaults to 90%. For vehicles equipped with lithium iron phosphate batteries, the charging limit defaults to 100%.
- It is recommended to use the default limit, which can effectively protect the health of traction battery.

Planned slow charging

Operation

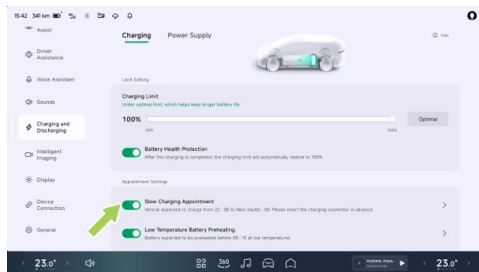

On the “→Charging and Discharging→Charging” interface of the CID, turn on “**Slow Charging Appointment**” to set the start and end times for charging. This allows the use of off-peak electricity rates during nighttime hours, reducing charging costs.



i Tips

Before enabling the scheduled slow charging function, ensure the charging pile reservation function in the mobile app is disabled; otherwise, the scheduled charging may fail.

! caution

When using scheduled slow charging, plug in the charging gun and lock the vehicle to prevent others from removing the charging gun.

Temperature control before fast charging

Operation



On the “🚗→Charging and Discharging→Charging” interface of the CID, you can turn on “**Temperature Control before Fast Charging**”. When this function is turned on, and the navigation destination is set to a fast-charging station, the vehicle will control the traction battery temperature to the optimal charging range, reducing charging time. Before



enabling navigation to a familiar charging station, you can manually turn on or off the **“Battery temperature preconditioning now”** function.

i Tips

This function will heat or cool the traction battery, which will consume part of the traction battery power.



Intelligent driver assistance-hardware

Radar

To ensure the radar operates properly:

- Keep the radar surface clean, free from ice, snow, water, dust, or other debris.
- If foreign objects are found on the radar surface, wipe it with a soft cloth or clean it using water (low water pressure).

Camera

To ensure the camera operates properly:

- Keep the camera surface clean, free from ice, snow, water, dust, or other debris. Please keep the front windscreen clean.
- Ensure the windscreen in front of the camera remains clean and there shall be no object between the camera and the windscreen.
- If foreign objects are found on the camera surface, wipe it with a soft cloth or clean it using water (low water pressure).

Open/close the front hood

Operation

Open the front hood



1. Pull the front hood release handle located on the lower right side of the instrument panel twice consecutively to unlock the front hood, which will slightly pop up.



2. Lift the front hood to its limit position, remove the support rod from the fixing groove, and secure it into the opening on the hood.

Close the front hood

1. To close the front hood, slightly lift it, place the support rod back into the fixing groove, and then lower the hood to about 30 cm from the closed position. Release it and allow it to fall freely.
2. After closing, check if the front hood is fully locked. The instrument panel or CID will

display the status of the front hood (open/closed).

Coolant

Introduction

Please check the coolant level within the specified maintenance period.

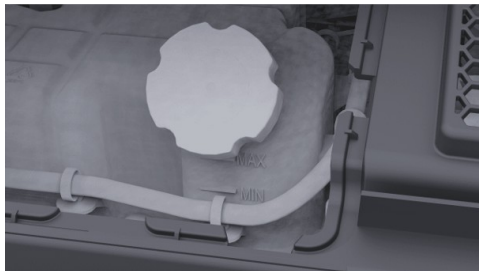

Check the level mark on the side of the coolant reservoir:

- MAX: Upper limit mark

Daily maintenance



- MIN: Lower limit mark

The coolant level shall be between MIN and MAX marks. If it is lower than the MIN mark, add coolant approved by XPENG in time.

warning

To add coolant, open the front hood and contact the XPENG Service Center to avoid accidental contact with HV components that may cause personal injury.

Operation

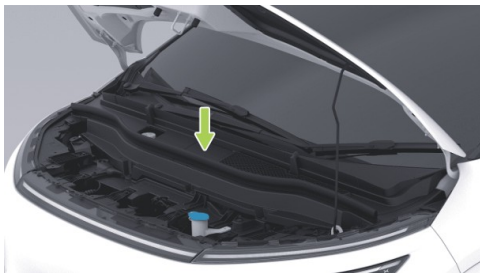

1. Remove the access cover plate with a proper tool to access the coolant reservoir.
2. Clean the reservoir cap to prevent dust from entering,



3. unscrew and remove the cap, and add the coolant.
4. Install the reservoir cap and access cover plate in an order reverse to their installation.

caution

To maximize the performance and lifespan of the traction battery, motor, and A/C system,



the cooling system uses a specific type of coolant (with a freezing point selected according to the local minimum temperature).

Brake fluid

Introduction

If the brake fluid level in the reservoir is below the required level, the brake light on the instrument panel will trigger an alarm. If there is an alarm during driving, please stop safely at the roadside. Do not continue driving, and contact the XPENG Service Center immediately.

warning

- To add brake fluid, open the front hood and contact the XPENG Service Center to avoid accidental contact with HV components that may cause personal injury.
- If the brake pedal feels loose or the brake fluid level drops significantly, contact the XPENG Service Center immediately. Driving under these conditions may increase

braking distance or result in total brake failure.

- The specifications for the brake fluid are indicated on the packaging. Only use brake fluid that meets the vehicle's specifications, and always use new brake fluid. Using old or incompatible brake fluid will degrade braking performance and may lead to brake system failure. It is recommended to use XPENG original or approved brake fluid.
- Brake fluid is toxic and must be disposed of in accordance with environmental regulations when releasing or handling waste brake fluid.



Check the level mark on the side of the brake fluid reservoir:

- MAX: Upper limit mark
- MIN: Lower limit mark

The brake fluid level shall be between MIN and MAX marks. If it is lower than the MIN mark, add XPENG original or approved brake fluid in time.

i Tips

Add brake fluid until the level is close to the MAX mark (but do not exceed it). After adding

brake fluid, ensure the reservoir cap is properly installed.

Operation

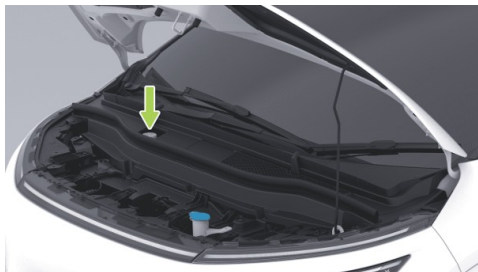

1. Clean the reservoir cap to prevent dust from entering.



Daily maintenance





2. Unscrew and remove the reservoir cap.
3. Add brake fluid approved by XPENG until the level is near the MAX mark.
4. Install the reservoir cap in an order reverse to its installation.

warning

- Please use the new brake fluid in an airtight bottle. Do not use brake fluid that has been used or in an opened container. Brake fluid absorbs moisture, which reduces braking performance.

- The brake fluid is highly toxic. Keep container tightly closed and out of reach of children. If accidental contact occurs, seek medical attention immediately.
- Brake fluid can damage painted surfaces. Immediately absorb spills with an absorbent cloth, followed by washing the affected area with a mixture of vehicle cleaner and water.
- The brake fluid reservoir may be obstructed by components in the front trunk, making it difficult to accurately inspect the brake fluid level. If necessary, contact the XPENG Service Center for assistance.
- During vehicle use, the brake fluid level may decrease slightly due to the automatic adjustment of brake pads as they wear. This is considered normal. However, if the fluid level drops significantly in a short period, falls below the "MIN" mark, or requires frequent replenishment, this indicates a potential brake system leak. Contact XPENG Service Center immediately for a brake system inspection.



- If the brake fluid level in the reservoir is below the specified level,  on the instrument panel will illuminate. The display may show relevant messages or alerts prompting the driver to take immediate action. In such cases, stop the vehicle immediately, do not continue driving, and contact the XPENG Service Center as soon as possible for a brake system inspection.
- If  on the instrument panel does not go out or illuminates during driving, it indicates that the brake fluid level is too low. In order to prevent accidents, stop the vehicle immediately and do not continue driving. Contact XPENG Service Center as soon as possible.
- Brake fluid is hygroscopic and will absorb moisture from the air over time. If the water content in the brake fluid becomes too high, it can corrode the brake system, significantly reduce the fluid's boiling point, and cause vapor lock during emergency stop, thereby compromising braking performance. For this

reason, brake fluid must be replaced every 24 months. If the vehicle has traveled over 40,000 kilometers before 24 months, the brake fluid must also be replaced.

- Never store brake fluid in food containers, beverage bottles, water cups, or any non-original brake fluid containers, as this could lead to accidental ingestion and poisoning.

Add windscreen washer fluid

Introduction

Check the washer fluid regularly. If it is found that the Low washer fluid level indicator  on the instrument panel illuminates, add washer fluid to the reservoir in time.

Periodically activate the washer switch to check for nozzle blockages and ensure proper spray performance.



Operation

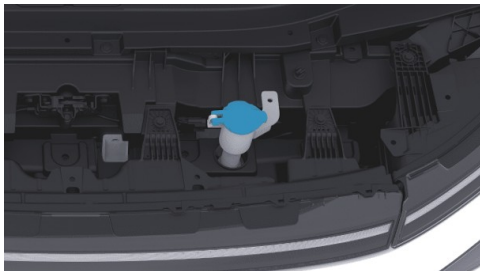

1. Clean the reservoir cap to prevent dust from entering,
2. Open the reservoir cap.
3. Add washer fluid until the fluid level is just below the filler neck.

warning

- Avoid spilling windscreen washer fluid on body panels. If spillage occurs, wipe it off immediately and rinse the area with clean water.

- Select a washer fluid with a freezing point lower than the local minimum temperature based on the climate. Non-compliant washer fluids may damage the windshield washer system.

Replace the front wiper blade

Introduction



On the “→Vehicle” interface of the CID, turn on “**Wiper Maintenance Mode**”. The wiper arms will move to the maintenance position. Turn off

Daily maintenance



“**Wiper Maintenance Mode**”, and the wiper arms will automatically return to their default position.

caution

Before replacing the wiper blade, be sure to turn on “**Wiper Maintenance Mode**”; otherwise, damage will be caused to the vehicle.

Operation

1. On the “→**Vehicle**” interface of the CID, turn on “**Wiper Maintenance Mode**” and the wiper arms will move to the maintenance position.

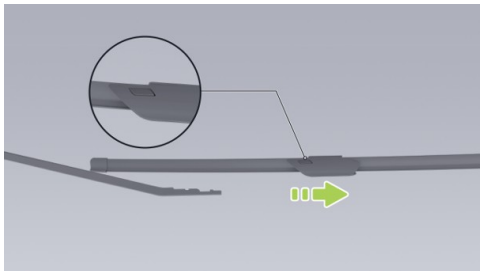

2. Lift the wiper arm, press the side locking button, and pull out the wiper blade to remove it.
3. Install the new wiper blade by following the reverse procedure until you hear a “click,” indicating proper installation.
4. Gently lower the wiper arm back into the windscreen.
5. Turn off “**Wiper Maintenance Mode**”.

Traction battery

Introduction

The traction battery is mounted at the bottom of the vehicle, so drive cautiously!

caution

- Be careful when driving on special roads such as muddy roads, uneven terrain, curbs, high and wide speed bumps, or sidewalk slopes, to avoid chassis crash that may scratch or damage the traction battery.



- Be careful when driving through roads with deep water to prevent the traction battery from short circuit, electric leakage or damage due to excessive water exposure.

warning

If scraping is detected on the chassis or there is an unusual smell from the traction battery, stop using the vehicle immediately and contact the XPENG Service Center.

Driving range

The driving range is influenced by factors such as the remaining traction battery charge, total mileage and time, ambient temperature, road conditions, driving habits (use of A/C, driving mode, energy recovery level), and the vehicle's load.

Ambient temperature

Ambient temperature affects the performance of traction battery. The vehicle shall be used in temperatures ranging from -30°C to 55°C to

maintain optimal battery performance and extend its lifespan.

caution

Do not continuously expose the vehicle to an environment with a temperature higher than 55°C or lower than -30°C .

Traction battery maintenance

The traction battery will discharge slowly, even if the vehicle is not in use. The lifespan and performance of traction battery will be reduced if the battery level is too low, shortening the vehicle's driving range. Therefore, before long-term parking, check the remaining battery charge and maintain it at 30%-60%. If the charge is insufficient, recharge to meet the parking requirement before leaving the vehicle.

Please refer to the chart correlating battery level and parking duration to ensure sufficient charge for parking:

Daily maintenance



Driving range or battery level	30%	50%	60%
Parking days	≤90	≤150	≤180

It is recommended to power up and check the battery every three months. If the battery level is too low, recharge promptly to avoid performance degradation due to undervoltage.

The lifespan of traction battery is also impacted by the ambient temperature. When the ambient temperature is low, the vehicle's driving range may decrease and charging time will increase.

i Tips

- Recommended charging temperature: 0 ~ 45°C. When the operating ambient temperature is lower than 0°C, the charging time will be extended.

- Long-term parking in high-temperature or extremely cold environments accelerates traction battery degradation. It is recommended to park in cool, dry, and ventilated locations, away from heat sources (such as heating pipes) or low-lying areas, and far from flammable, explosive, or corrosive substances.
- Avoid prolonged or frequent driving in waterlogged areas.
- Do not allow the traction battery to discharge completely.

Maintenance of lithium iron phosphate battery*

For vehicles equipped with lithium iron phosphate batteries, follow these recommendations to accurately estimate driving range and maintain battery health:

- After taking delivery of the vehicle, charge the battery to 100% as soon as possible (for the first three charges, it is recommended to use fast charging to reach 100%). During regular use, always keep the charge limit set to 100%,



and fully charge the battery to 100% at least once every two weeks or 1,000 kilometers (both fast and slow charging are acceptable).

- In winter, when temperatures are lower, it is recommended to maintain a remaining range of no less than 100 kilometers.
- During vehicle parking, avoid prolonged use of the trunk's 12V delayed power-off function to reduce battery consumption. If the vehicle is parked for more than one week, perform a full charge.

Charging base

Introduction

Under normal use, clean the charging base and charging gun weekly using a high-pressure air gun or a brush. If these tools are unavailable, use a lint-free cloth or cotton swabs for cleaning.

warning

Sharp objects such as screwdrivers or tweezers are strictly prohibited from touching

the charging gun pins or charging sockets to avoid damaging them.

Tires

Introduction

Inspection and maintenance of tires

Check tire pressure regularly and, if inflation is needed, follow the tire pressure specifications on the label on the passenger-side B-pillar to adjust it.

Inspect tire treads regularly for abnormal wear, punctures, or nails. Regularly check the tire sidewalls for bulges, cuts, or other damages.

Tire wear

Sufficient tread depth is critical to tire performance. Tires with a tread depth below 2 mm are more prone to skidding on wet roads and should not be used. Tires with a tread depth below 4 mm perform poorly on slush-covered

Daily maintenance



roads and should not be used during winter driving.

To reduce tire wear and extend tire life, maintain tires based on your driving habits and road conditions:

- Avoid rapid starts or hard acceleration.
- Avoid sharp turns and hard braking.
- Drive slowly over potholes, curbs, or similar obstacles.
- If uneven tire wear is observed, perform a four-wheel positioning inspection.
- It is recommended to rotate the tires every 10,000 kilometers.

i Tips

After tire rotation, it is necessary to update the TPMS sensor ID. To avoid TPMS malfunction, visit XPENG Service Center for tire rotation.

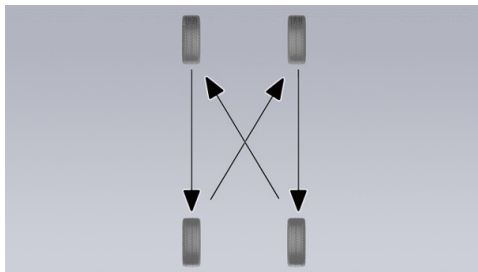

Tire and wheel replacement

Due to exposure to UV rays, extreme temperatures, heavy loads, and environmental conditions, tires naturally age over time. Normal tire wear occurs during regular driving, including acceleration, braking, and cornering. XPENG Service Center will inspect tire wear during maintenance and recommend tire replacement if necessary. In special cases, such as when the tread wears down to the wear indicator, or if the tire surface is scratched or punctured,



immediately visit XPENG Service Center to replace the tire.

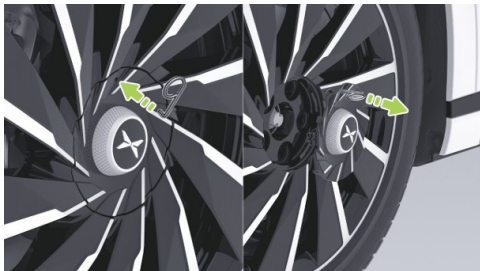

When replacing the tire, use the hook from the vehicle's tool kit. Insert it into the removal hole on the edge of the rim center trim cap, pull outward to remove the cap, store the hook back in the tool kit afterward, and keep it properly. During installation, align the rim center trim cap and press it hard until it clicks into place.

caution

Please use tires and hubs that match the original specifications of the vehicle. Tires that do not match the original specifications may affect the functionality of intelligent driver assistance system and the tire pressure monitoring system.

warning

- Do not drive the vehicle if the tires are damaged, excessively worn, or improperly inflated. Regularly check tire wear to ensure there are no cuts or bulges.
- After installing new or repaired tires, perform a wheel balancing procedure.

Seasonal tire types

Summer tires

Summer tires are designed for extremely dry and wet road surfaces but are not suitable for winter conditions. For driving in low temperatures or on



icy and snowy roads, it is recommended to use winter tires.

All-season tire

This type of tires are specifically designed to provide adequate traction in all seasons of the year. However, they may not offer the same level of traction as winter tires on icy and snowy roads. All-season tires are marked with “**ALL SEASON**” and/or “**M+S**” (mud and snow) logo on the sidewalls.

Winter tires

Winter tires can enhance traction on icy and snowy roads. When installing winter tires, ensure that a full set of four tires is installed. All four tires must be of the same specification, brand, construction, and tread pattern. Contact XPENG Service Center for advice on winter tires.

When driving a vehicle equipped with winter tires, increased road noise, shorter tread life, and reduced traction on dry roads may occur.

warning

- If uneven or excessive tire wear is detected, visit XPENG Service Center promptly to check wheel balance and perform four-wheel positioning.
- Insufficient tire pressure is the most common cause of tire failure, potentially leading to overheating, cracking, tread separation, or blowouts, which may result in loss of vehicle control and increased injury risk.
- Insufficient tire pressure can also shorten the vehicle's range and reduce tread life.
- Do not use any tire sealant (other than the type provided in the vehicle's tire repair kit). Other types of sealants may cause a fault in the tire pressure sensor.



Brake pad

Introduction

It is recommended to check whether the brake pads are worn to the alarm plate position during each maintenance or long-distance driving.

If unusual noises occur during braking, check the brake pads and replace them if they are worn to the alarm plate position.

Use only original brake pad parts for replacement.

Vehicle cleaning

Exterior cleaning

Exterior cleaning

Frequent vehicle washes help protect the vehicle's appearance.

Wash the vehicle in a shaded area and only after the vehicle has cooled down to prevent damage to the paint caused by direct sunlight.

Follow the vehicle washer operator's guidance when using an automatic vehicle washer.

Before washing the vehicle, make sure that the windows are closed. During vehicle washing, avoid using high-pressure water jets on the corners of windows, as water may enter the interior through the corners.

In winter, dry the seams around the door handles after washing to prevent them from freezing.

Promptly remove corrosive substances (bird droppings, tree sap, insects, tar spots, road salt, industrial dust, etc.) to prevent damage to the paint.

When cleaning the exterior of the vehicle body, please follow these steps:

1. Preparation before cleaning
 - Close all doors, the trunk and the front hood. Check whether the charging port is completely closed.
2. Thorough rinse



- Before washing, use a hose to rinse off dirt and grit from the exterior of the vehicle body. Please pay extra attention to areas prone to dust, mud, or road salt accumulation (such as wheel arches and panel seams).
3. Hand wash
 - Mix a high-quality neutral vehicle cleaner with cold or warm water. Use a soft cloth to hand wash the exterior of the vehicle body.
 4. Rinse with clean water
 - After washing, rinse thoroughly with clean water to prevent soap residue from drying on the surface.
 5. Dry with soft cloth

Precautions for exterior cleaning

- Do not use hot water or detergents.
- If using a high-pressure washer, keep the nozzle at least 30 cm away from the vehicle body's surface. Continuously move the nozzle and avoid spraying any single spot for too

long. Do not spray water from the nozzle towards the charging port.

- When washing the vehicle in low-temperature conditions or parking outdoors during snowy weather, the active grille shutters may freeze and become inoperative. The instrument panel may display an active grille fault, which is normal and does not affect the vehicle's regular use. The issue will resolve automatically after driving for a while (approximately one hour) or using a heat gun to defrost the shutters. If the issue persists after defrosting, contact the XPENG Service Center for inspection.
- Do not spray water from the hose directly towards windows, door seals, or brake components through wheel hub openings.
- Avoid using cotton cloths, coarse cloths, or automotive cleaning mitts.
- Do not use chemical tire cleaners, as they may damage the surface finish of the wheels.
- During vehicle washing, avoid using high-pressure water jets to impact the switch area



of the charging port cover; otherwise, the charging port cover may be opened.

Cleaning and maintenance of exterior plastic parts

It is usually cleaned with clean water, soft cloth and soft brush.

Cleaning of windows and rearview mirrors

Use an alcohol-based glass cleaner to clean windows and rearview mirrors, and then dry the surface with a clean and lint-free soft cloth.

If wax from body surface treatments remains on the glass, remove it using specialized cleaner and cleaning cloth to prevent damaging the wiper blades.

Use a small brush to remove snow from windows and rearview mirrors.

Use a de-icing spray to remove ice, or carefully use an ice scraper, taking care to avoid damaging components and scraping in the same direction.

! caution

- Do not use hot water to remove ice or snow from windscreen and rearview mirror, as it may cause the glass to crack.
- Any residual rubber, grease and silica gel on the glass must be removed with a special window cleaner or silica gel cleaner.

Maintenance of seal strips

Use a soft cloth to remove dust and dirt from seal surfaces during seal strip maintenance. Regularly apply special protective agent to the rubber seal strip.

Cleaning of wiper blades

Regularly inspect and clean the edges of the wiper blades. Check for rubber cracks, tears, and roughness. If damaged, contact the XPENG Service Center for replacement.

Wiper performance may decrease due to contaminants on the wiper blade, such as ice, vehicle-washing wax, cleaning fluids containing

Daily maintenance



bacteria or water repellents, bird droppings, leaves, and other organic materials.

Clean wiper blades as follows:

1. On the “Vehicle” interface of the CID, turn on “**Wiper Maintenance Mode**”.
2. Slightly lift the wiper arms off the windscreen, just enough to access the wiper blades. Use isopropyl alcohol or wiper cleaning fluid to clean the wiper blades thoroughly.
3. If the wiper blades remain ineffective after cleaning, replace them promptly.

caution

- When lowering the wiper arms, handle them carefully to avoid dropping them onto the windscreen.
- Wiper blades have a graphite coating to ensure smooth wiping and reduce noise. Cleaners containing solvents, hard sponges, or sharp objects can damage the graphite layer. Damage to the graphite layer will

increase wiping noise, and the wiper blades should be replaced promptly.

- In winter or cold conditions, ensure the wiper blades are not frozen to the windscreen before using the wipers. If frozen, carry out deicing treatment first; otherwise it will cause damage to the wiper blade and wiper motor.
- When cleaning the windshield, wiper blades, or replacing the wiper blades, lift the wiper arm instead of directly grabbing the wiper blades to avoid deformation, which may cause abnormal noise and reduce wiping performance.

Cleaning of windscreen

Use a specialized cleaner to clean the windscreen.

Contaminants on the windscreen may affect its hydrophilic properties; clean them promptly. Contaminants include dust, oil films, bird droppings, leaves, and other debris.



caution

- Do not use cleaning products containing ammonia or chlorine, such as household glass cleaners, as they accelerate the aging of wiper rubber strips.
- Do not use water-repellent materials (such as waxes and coatings) on the windshield, as they increase the hydrophobicity of the glass surface, and reduce cleanliness of the windshield.

Interior trims cleaning

Regularly inspect and clean the interior trims to maintain a neat and new appearance and prevent premature wear.

caution

- It is recommended to use automotive products free of plasticizers. Products with high plasticizer content may react with PU interior materials, causing issues such as bulging.

- To prevent interference with the pedals, ensure the driver's foot mat is properly secured and avoid layering mats on top. Floor mats should always rest directly on the vehicle's carpet surface.
- Using solvents (including alcohol), bleach, citrus cleaners, naphtha, silicone-based products, or additives may damage the interior trims.
- Electrostatic substances can harm the CID and instrument panel.
- Do not wipe door shield with wet wipes, wet cloths, or cleaners, and take protective measures during vehicle use (e.g., on rainy days or during vehicle washing) to avoid water ingress into the door shield, which may cause faults in internal electrical components.
- If you notice any damage to the airbag or seat belt, contact the XPENG Service Center immediately.

Daily maintenance



- Seat belts must be kept free of water, cleaner, or fabric.

Interior trims glass

It is strictly prohibited to scratch the glass or mirror surface or to use any abrasive cleaning solution. Otherwise, the mirror reflective surface and rear window heating elements may be damaged.

IP and plastic surfaces

It is strictly prohibited to polish the upper surface of the IP, because the polished surface is easy to reflect light and may interfere with the driving vision.

Seat cleaning

If seats are stained, use a soft cloth dipped in warm water and neutral soap solution to gently wipe in circular motions, and then dry with a lint-free soft cloth.

Carpet

Use a vacuum cleaner with a soft brush head to remove dust and scum. For stubborn stains, try to remove them with water or soda water first. Before cleaning, please use an appropriate method to remove stains:

- For liquid stains: Gently blot with tissue paper to absorb as much of the stain as possible.
- For solid, dry stains: Manually remove as much as possible, and then use a vacuum cleaner.

CID and instrument panel

Clean the CID and instrument panel with a special clean lint-free soft cloth. Do not use cleaners (e.g., glass cleaners), wet cloths, or static-laden dry cloths (e.g., freshly washed microfiber cloths).

Pull down the quick menu on the CID and turn on cleaning mode before wiping to prevent button activation and setting changes.



caution

It is forbidden to clean the CID with corrosive liquids such as acidic/alkaline cleaners, deoxidizing cleaners, or sodium hypochlorite (e.g., 84 disinfectant).

Chrome-plated and metal surfaces

Polishes, abrasive cleaners, or hard cloths can damage the finish of chrome-plated and metal surfaces.

Foot mat

To extend the lifespan of the carpet and facilitate cleaning, use genuine XPENG-approved foot mats. Regularly clean the foot mats and ensure they are properly installed. Replace foot mats promptly if they become excessively worn.

Emergency rescue



Emergency device

Emergency device information

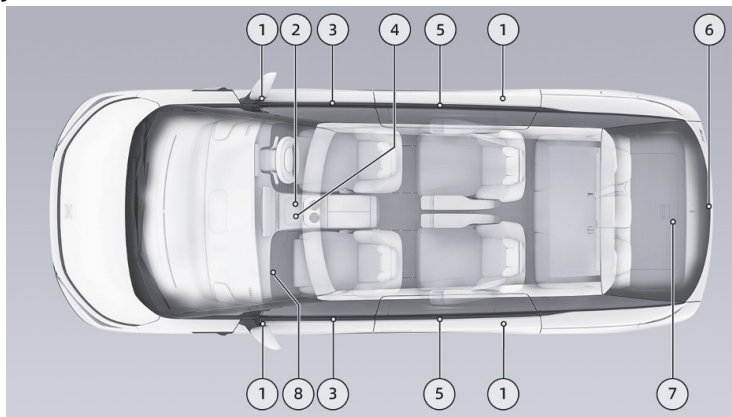



Emergency rescue

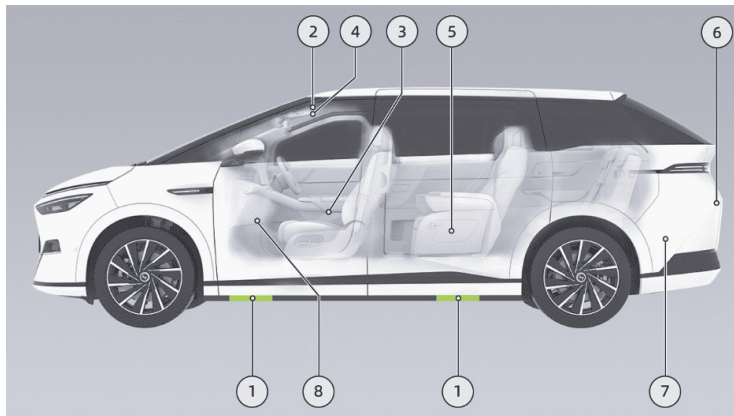



1. Vehicle lifting points



Vehicle lifting points can be identified by the arrows on the door lower trim panel.

warning

- It is recommended to have lifting operations performed by professionals approved by XPENG Service Center. The traction battery is installed at the bottom of the vehicle, and improper lifting by non-professionals may damage the HV system. There is also a risk of accidental

vehicle slippage. XPENG assumes no responsibility for direct or indirect losses caused by improper self-lifting.

- When the vehicle is lifted, the “**Suspension Maintenance Mode**” must be activated. Once the lifting operation is completed and the vehicle is lowered to the ground, the “**Suspension Maintenance Mode**” must be deactivated; otherwise, it may cause damage to the vehicle.
- It is forbidden to lift the vehicle while occupants are inside.
- When using a jack to lift the vehicle, ensure operation is performed on flat and solid ground.
- Do not enter beneath a vehicle supported only by a jack, as this may result in serious injury or death.

2. Hazard warning lights



In case of emergency while driving, press the hazard warning light switch to activate the hazard warning light. The turn signal will flash. Press the switch again to deactivate the hazard warning light.

i Tips

The hazard warning light can be activated whether the vehicle is powered on or off.

3. **Electric door emergency release handle**

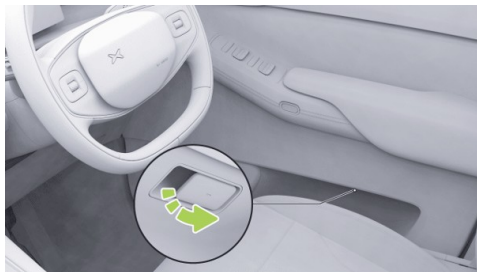

Specific operations, refer to [See 174 page](#).

4. **Emergency power-off switch**



Specific operations, refer to [See 185 page](#).

5. Slide door emergency pull ring



Specific operations, refer to [See 176 page](#).

6. Trunk emergency open switch

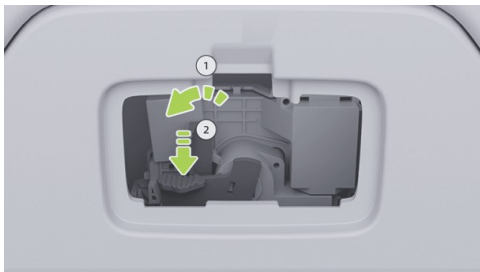

Specific operations, refer to [See 181 page](#).

7. Emergency Device

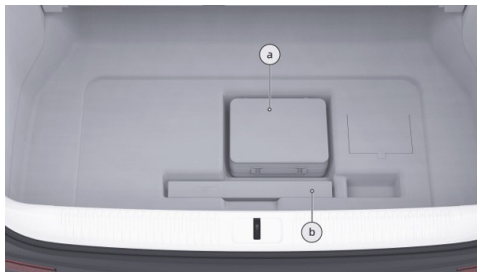

- a. In-vehicle tool kit: towing hook, wheel house removal hook, and emergency tools for tire inflation and repair.
- b. Warning triangle.

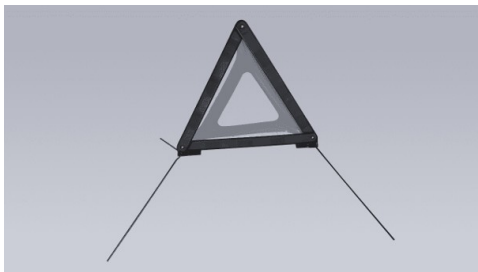

In the event of an emergency, remove the warning triangle, unfold it, and place it behind the vehicle. The placement positions are shown in the following table.

General highway	General highway	Expressway
Day	Night	Expressway
≥ 50m	≥ 80m	≥ 150m

8. Safety vest



Please keep the safety vest in the glove box for easy access before exiting the vehicle.



Temporary tire repair

Temporary tire repair

The vehicle is not equipped with a spare tire. An emergency tire repair kit is provided with the vehicle.

The emergency tire repair kit includes an air pump and a canister of tire sealant (sufficient to repair one tire). When injecting the tire, the tire sealant will seep into small punctures in the tire with a maximum size of 6 mm, serving as a temporary fix.



warning

- For punctures larger than 6 mm, severe tread damage, sidewall damage, tire tears, or if the tire has detached from the hub, please contact the XPENG Service Center.
- The emergency tire repair kit is intended for temporary single-use repairs only. The



damaged tire must be repaired or replaced as soon as possible.

- If a tire temporarily repaired with tire sealant is used, the driving speed shall not exceed 80 km/h.
- Please read and follow all warnings and instructions provided with the emergency tire repair kit.
- If the vehicle's tire becomes flat, do not continue driving, as this may cause serious injury.

Tire sealant

The tire sealant provided in the emergency tire repair kit is specially designed for XPENG vehicles and will not damage the tire pressure sensors. Therefore, only the same type and capacity of tire sealant shall be used for replacement. Tire sealant can be purchased from XPENG Service Center.

The expiration date is printed on the tire sealant container. If the expiration date has passed, the

tire sealant may lose its intended effectiveness. Be sure to purchase new tire sealant.

warning

- Do not use tire sealant purchased from other channels, as this may cause the tire pressure sensors to malfunction.
- Be sure to read and follow the safety and operation instructions of the tire sealant.
- Keep the tire sealant out of the reach of children.
- If the tire sealant comes into contact with the eyes, rinse immediately with water and seek medical attention.
- If the tire sealant is accidentally ingested, seek medical attention immediately.
- If the tire sealant is inhaled, move to fresh air immediately to avoid respiratory issues and seek medical attention.



Tire repair and inflation

Follow the steps below to temporarily repair small tire punctures (less than 6 mm):



1. Remove the emergency tire repair kit from the trunk.
2. Take out the air pump and tire sealant from the kit.



3. Take out the tire sealant container and shake it evenly.



4. Screw one end of the tire sealant connecting hose tightly onto the tire valve. Ensure the sealant container is not inverted.



5. Connect the other end of the tire sealant hose to the air pump and tighten it, and connect the power cord of the air pump to the 12V power supply in the vehicle storage box.



6.
 - a. Turn on the switch to start the air pump, which will inflate the tire.
 - b. During the sealant injection process, the pressure gauge shows a pressure range of approximately 300-600 kPa.
 - c. Observe the pressure gauge and stop inflating once the tire pressure reaches the standard value.
- d. Refer to the tire pressure label for the standard tire pressure of the specific tire specification.
- e. Check the tire pressure. If the tire cannot reach the specified pressure within 20 minutes, the repair is considered unsuccessful.
7. Turn off the air pump and disconnect the hose from the tire valve. Wipe off any excess tire sealant from the tire valve and the hub. Disconnect the hose from the air pump, and return the emergency tire repair kit to the trunk.
8. Drive immediately for 5 km or 10 minutes to allow the sealant to distribute evenly inside the tire. Maintain a speed of 20-60 km/h.
9. Stop and check the tire pressure.

⚠ caution

If the tire pressure is below 130 kPa, the tire damage cannot be repaired with the sealant. Park the vehicle safely by the

Emergency rescue



roadside and contact the XPENG Service Center.

10. Inflate the tire to the standard pressure.
11. Store the air pump back in the trunk.
12. Drive the vehicle to XPENG Service Center at a speed of 20~80 km/h for tire repair.

caution

- Please repair or replace the damaged tire as soon as possible.
- After using the tire sealant, purchase a new tire sealant promptly.
- Do not exceed a driving speed of 80 km/h.

Inflation only



1. Remove the emergency tire repair kit from the trunk.
2. Take out the air pump from the emergency tire repair kit.



Emergency rescue



3. Take out the connecting hose and power cord from both sides of the air pump.
4. Attach the air pump connecting hose to the tire valve and tighten it.
5. Connect the power cord of the air pump to the 12V power supply of vehicle.



6. Turn on the switch to start the air pump, which will inflate the tire.
 - Observe the pressure gauge and stop inflating once the tire pressure reaches the standard value.
 - Refer to the tire pressure label for the standard tire pressure of the specific tire specification.



7. Turn off the air pump.

caution

- Please inflate the tire to the standard pressure value; otherwise, excessively high or low tire pressure may accelerate tire wear.
- If the tire pressure is too high, reduce the pressure by releasing air.
 - Operation steps: remove the inflation hose and press the metal pin at the center of the valve to release air. During this process, you can reconnect the hose to monitor the pressure gauge until the pressure decreases to the standard value.
- After adjusting the tire pressure, if the Tire Pressure Monitoring System (TPMS) indicator does not turn off, drive the vehicle at 40 km/h for a short distance and check the indicator status.
- During vehicle operation, the tire pressure may slightly increase due to rising tire temperature, which is a normal physical phenomenon.

- If the TPMS indicator remains lit, contact the XPENG Service Center.

Rescue and protection equipment

Introduction

The vehicle is battery-driven, and serious impact may lead to the leakage of high voltage. For this reason, vehicle rescue should be performed by professionals wearing appropriate personal protective equipment.

warning

To avoid electrical injury, remove metal objects, such as a necklace or watch, when operating the vehicle.

Protecting against electrical injury

To avoid high-voltage electrical injury, wear the following personal protective equipment:

- Rubber insulating gloves (for voltage above 500V);



- Goggles;
- Insulating rubber shoes;
- Tools with insulating sleeves.

Protecting against chemical injury

If the traction battery leaks electrolyte, wear the following personal protective equipment to protect your skin, face, and other body parts from injury:

- Protective mask;
- Solvent insulated gloves;

Protection against crash

Introduction

In the event of a crash, the high-voltage cutoff and discharge function In case of a crash, if the trigger conditions are met, the vehicle will automatically cut off the high-voltage power supply and instruct the occupants to immediately exit the vehicle to prevent risk to their safety.

Jump start

Operation

This vehicle's battery features a lock function. When the battery charge is too low to start the vehicle, first pull the Driver's seat side handle and hold for 10 seconds to wake up the battery, and then unlock with the key. Press the brake pedal within 1 minute to power on and charge the battery; otherwise, the battery will re-enter lock mode.

If the battery cannot be awakened after multiple attempts with the front right door handle and the vehicle won't start, follow these steps:

Emergency rescue

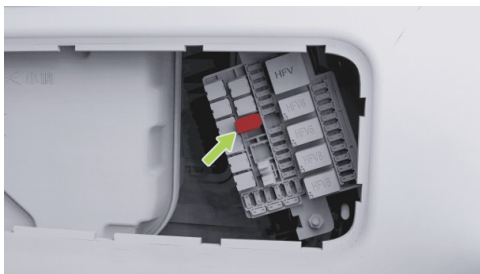

1. Open the trunk and remove the trunk repair cover plate using appropriate tools.

2. Remove the red protective cap from the positive terminal clamp point in the fuse box.

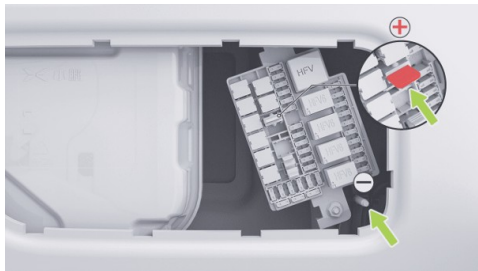

3. Connect one end of the red cable of the 12V charger to the positive terminal clamp point of this vehicle and one end of the black cable to the negative terminal clamp point for charging.

i Tips

If the traction battery voltage is too low for normal 12V charging, use a 12V lithium battery (not the vehicle's own battery) or



lead-acid battery. Connect one end of the red cable to the positive terminal clamp point of this vehicle and the other end to the positive terminal (+) of the auxiliary power supply. Connect one end of the black cable to the negative terminal clamp point of this vehicle and the other end to the negative terminal (-) of the auxiliary power supply.

warning

When connecting, do not reverse the polarity of the battery or auxiliary power supply, and avoid short circuits, as this may damage the vehicle's harness fuse.

4. Start the vehicle. After successful startup, remove the cables in reverse order of connection.
5. Reinstall components in reverse order of removal.

warning

- It is forbidden to remove or modify the battery without permission. Do not charge the battery with an external power supply.
- It is prohibited to jump-start the vehicle battery.
- Before repair, please disconnect positive and negative connectors. Do not reverse battery polarity.
- It is prohibited to use the battery of this vehicle to jump-start other vehicles.
- Improper cable connection may cause battery explosion, resulting in personal injury.
- Auxiliary power supply voltage must match the vehicle battery's voltage and capacity to prevent explosion.
- Do not expose the battery to open flames or static electricity. Otherwise, combustible gas generated by the battery may be ignited by sparks and cause explosion accidents.

Emergency rescue



- Do not touch HV components during operation to prevent injury from HV electric shock.

E-call*

Introduction

E-call is the vehicle's intelligent emergency call system that automatically or manually dials emergency services when accidents or emergencies occur, providing vehicle location and passenger injury information to help rescue personnel reach the scene promptly and assist trapped occupants.



Operation

In case of an emergency, the following methods can be used to call for assistance:

- Manual call: Press and hold the SOS switch for more than 3 seconds to initiate an emergency call. If you wish to cancel the call while waiting for a connection, press the switch again.
- Automatic call: When the vehicle is involved in a crash that triggers airbag deployment, the system will automatically initiate an emergency call.



- Callback: If the call is not connected or is interrupted, the system supports call redial within a certain period.

i Tips

- When waiting for or during an active rescue call, the SOS switch indicator light will illuminate green. If the system has a fault, the SOS switch indicator will illuminate red. In this case, you should seek assistance through alternative methods.
- After a rescue call is connected, only the rescue service can terminate the call.
- If the rescue call service period expires, the system will no longer provide assistance. Please check the validity period of rescue call service in time on the CID .
- In case of battery failure, the emergency call system will remain operational for a limited time to support calls.



Vehicle parameters

Size parameters

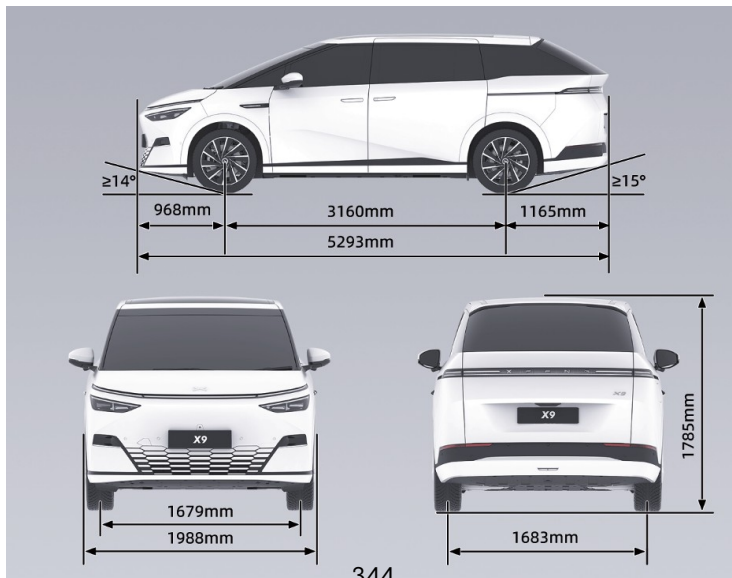



Overall dimension	Length (mm)	5293
	Width (mm)	1988
	Height (mm)	1785
Wheel track	Front track (mm)	1679
	Rear track (mm)	1683
Wheelbase (mm)		3160
Front suspension (mm)		968
Rear suspension (mm)		1165
Number of occupants (persons)		7
Approach angle (°)		14
Departure angle (°)		15



i Tips

The exterior rearview mirrors (one on each side) are not included in the exterior width measurement. The dimensional parameters of the vehicle allow a tolerance range of $\pm 1\%$.



Mass parameters

Item		Type I	Type II
Vehicle curb weight (kg)		2635	2585
Curb	Front axle (kg)	1345	1320
	Rear axle (kg)	1290	1265
Gross vehicle mass (kg)		3220	3170
Maximum	Front axle (kg)	1470	1445
	Rear axle (kg)	1750	1725

i Tips

The tolerance range of mass parameters is $\pm 3\%$, except for the maximum total mass.

User information



Performance parameters

Minimum turning diameter (m)	10.8 (rear-wheel steering)
Maximum speed (km/h)	200
Maximum gradient (%)	30



Wheels and tires

Tires		235/50 R20
Rims		20-inch rim
Pressure	Front/rear wheel (half load) (KPa)	270
	Front/rear wheel (full load) (KPa)	310
Wheel balancing (after attaching balance weights)	Front wheels, inner side (g)	≤8
	Front wheels, outer side (g)	≤8
	Rear wheels, inner side (g)	≤8
	Rear wheels, outer side (g)	≤8



Brake and suspension

Brake system type	Floating ventilated disc type
Brake system booster type	Electric power steering
Brake pedal free stroke or idle stroke (mm)	≤2
Wear limit of brake pad for front wheel (excluding the backing plate for brake pad) (mm)	2.5
Wear limit of brake pad for rear wheel (excluding the backing plate for brake pad) (mm)	2.5
Wear limit of front brake disc (mm)	30
Wear limit of rear brake disc (mm)	22
Front suspension type	Front double-wishbone independent suspension
Rear suspension type	Rear multi-link (H arm) independent suspension



User information

Rated working pressure of air suspension reservoir (bar)	20
--	----



Four-wheel positioning specifications

Positioning data

Project		Positioning parameters	
		Degrees °	Applicable configuration
Front suspension	Front wheel camber	$-0.5^{\circ} \pm 0.5^{\circ}$	All configurations (no load)
	Camber angle difference L&R	$0 \pm 0.5^{\circ}$	All configurations (no load)



User information

Project		Positioning parameters	
		Degrees °	Applicable configuration
	Kingpin inclination angle	$9.7^{\circ} \pm 1^{\circ}$	All configurations (no load)
	Castor angle	$7.1^{\circ} \pm 1.0^{\circ}$	All configurations (no load)
	Front wheel unilateral toe	$3' \pm 3'$	All configurations (no load)

Project		Positioning parameters	
		Degrees °	Applicable configuration
Rear suspension	Rear wheel unilateral toe	$9' \pm 6'$	All configurations (no load)
	Rear wheel camber	$-1.6^{\circ} \pm 0.5^{\circ}$	All configurations (no load)
	Camber angle difference L&R	$0 \pm 0.5^{\circ}$	All configurations (no load)



i Tips

- The front/rear toe-in and tilt angles in the table are measurements of single-sided wheels.



Main parameters of traction battery

Traction battery	Item	Unit	Standard range model	Long-range model
	Type	/	LFP	NCM
	Rated voltage (1C)	V	621.72	638.58
	Rated capacity (1C)	Ah	136	159
	Rated energy (1C)	kWh	84.5	101.5
	Mass (including shield)	kg	638±10	588±10



Electric drive type and parameters

		Front electric drive system
Drive motor	Type	Permanent magnet synchronous
	Rated power (kW)	110
	Rated torque (N·m)	170
	Rated speed (rpm)	6190
	Maximum power (kW)	235
	Maximum torque (N·m)	450
	Maximum speed (rpm)	18000
Reducer	Model	1ETP45A
	Number of gears	1



Seat adjustment parameters

In the initial position, the adjustment parameters of the seat are as follows:

Seat type	Item	Parameter
Driver's seat	Front/rear adjustment	Total travel: 260 mm; forward: 200 mm; backward: 60 mm
	Backrest adjustment	Total travel: 90°; forward: 25°; backward: 65°
	Cushion adjustment	Total travel: 8°; upward: 5°; downward: 3°
	Up/down adjustment	Total travel: 66.7 mm; forward: 33.3 mm; backward: 33.4 mm



Front passenger seat	Front/rear adjustment	Total travel: 260 mm; forward: 200 mm; backward: 60 mm
	Backrest adjustment	Total travel: 90°; forward: 25°; backward: 65°
	Cushion adjustment	Total travel: 8°; upward: 5°; downward: 3°
	Up/down adjustment	Total travel: 66.7 mm; forward: 33.3 mm; backward: 33.4 mm
Second-row seats (6-way)	Front/rear adjustment	Total travel: 570 mm; forward: 320 mm; backward: 250 mm
	Backrest adjustment	Total travel: 70°; forward: 30°; backward: 40°
	Cushion adjustment	Total travel 15°



User information

Second-row seats (4-way)	Front/rear adjustment	Total travel: 550 mm; forward: 320 mm; backward: 230 mm
	Backrest adjustment	Total travel: 95°; forward: 30°; backward: 65°
Third-row seats	Backrest adjustment	Total travel: 176°; forward: 98°; backward: 78°



Fluids and capacity

Introduction

	Model	Filling volume
Front electric drive lubricating oil (L)	FUCHS 4101	1.4
Coolant (L)	Mixture of glycol and water	18.4L
A/C refrigerant (g)	R134a	1550±25
Brake fluid (L)	DOT4	Fill to near MAX line (about 1.02L)
Windscreen washer fluid (L)	/	3.5



Nameplate and labels

Vehicle identification number (VIN)



The VIN is stamped under the driver's seat.

Other VINs are located in the following positions of the vehicle:

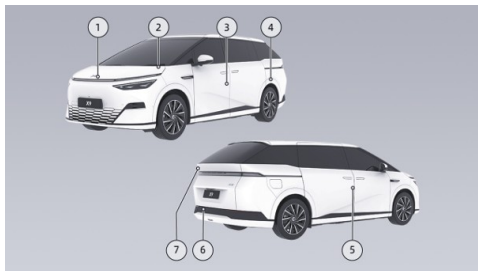

1. Affixed to the inner side of the front hood.
2. Affixed to the lower-left corner of the front windscreen.
3. Affixed to the left B-pillar.
4. Affixed to the rear left wheel house.
5. Affixed to the inner panel of the rear right door.
6. Affixed to the upper cross member of rear panel.
7. Affixed to the left side of the trunk lid.

User information



OBD diagnosis interface



The OBD port for reading the electronic VIN is located at the lower right of the instrument cluster. The electronic VIN, vehicle status information and other data can be read with the original manufacturer's diagnostic apparatus or diagnostic equipment officially approved by the original manufacturer.

Vehicle product nameplate



The vehicle product nameplate is located on the right B-pillar and can be viewed after opening the right door.

Drive motor model and number

Front drive motor

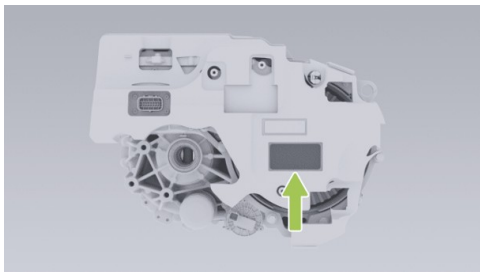

The drive motor model and serial number are displayed on the drive motor housing and the drive motor label.

Area permeable to radio waves



The microwave window is located on the windscreen.

warning

- Do not block the microwave window.
- The necessary markings for traffic regulations shall be affixed in a position around the microwave window.



Parts and modifications

Introduction

Only genuine XPENG original or approved parts may be used. XPENG has conducted rigorous testing on the parts to ensure their suitability, safety, and reliability. These parts can only be purchased from XPENG Service Center, installed by XPENG professionals, and vehicles may be modified based on the recommendations of XPENG experts.

Do not modify the vehicle using non-XPENG original or unapproved parts, as this may affect the vehicle's operability, safety, and durability, and may also violate local government regulations.

When modifying the vehicle body (such as applying color-changing film, transparent paint protection film, or anti-collision strips), avoid areas with ultrasonic radar, SRR, AVM cameras, and high-perception cameras, as this may affect

the normal operation of related functions such as driver assistance.

The SRR is located inside the front and rear bumpers. Painting, adding trims, or other modifications to the front and rear bumpers without permission is prohibited, as this may affect the normal operation of related functions such as driver assistance.

It is forbidden to replace, modify or add radars or cameras without permission. Otherwise, it may affect the normal operation of related functions such as driver assistance and may also cause radio interference. XPENG assumes no responsibility for any direct or indirect loss caused as a result. In case of any radar or camera fault, please visit XPENG Service Center for repairs.

Do not modify the vehicle's suspension or brake systems, as this may adversely affect the vehicle's handling and safety.



It is forbidden to modify the fuse box of the vehicle, otherwise it may adversely affect the electrical system of the vehicle.

Modifications to electronic components, software, or wiring can affect the functionality and normal operation of related components, particularly safety-related systems, thereby impacting vehicle operation and increasing the risk of accidents or injury.

Therefore, do not modify the wiring, electronic components, or their software.

In addition, damage to the vehicle or performance issues caused by the use of non-XPENG original or unapproved parts for replacement, installation, or modification are not covered under warranty. XPENG assumes no responsibility for any direct or indirect losses caused as a result.

Recycling requirements and procedures of traction battery

Introduction

When the traction battery needs replacement or disposal, please ensure to contact the XPENG Service Center for recycling and handling. Improper disposal of the traction battery may cause environmental pollution or safety hazards, and the vehicle owner shall bear the corresponding responsibility.



X Mobility (Thailand) Co., Ltd.
156 Ramkhamhaeng Rd, Hua Mak,
Bang Kapi, Bangkok

1526^{'''}
XPENG CALL CENTER

Printing code : X9022025