



**XPENG G6**  
**USER'S MANUAL**



XPENG G6 is an intelligent coupe SUV with features different from ordinary vehicles. Before starting the journey on your G6, it is recommended to read this manual to understand basic vehicle information, basic operations, and corresponding cautions and warnings. If you have questions regarding the use of the vehicle, please contact XPENG Service Center.

This manual is published in July 2024. Titles marked with “\*”, the described equipment, functions and pictures are only valid for a certain configuration. G6 is capable of upgrading over-the-air (OTA), and the features and configurations may be updated from time to time after remote upgrade. Therefore, XPENG would like to inform you about following reminders:

Please be familiar with the latest and most complete vehicle functions, vehicle usage techniques, precautions, etc. before using the vehicle after an upgrade, pay special attention to the warnings in this manual, and use the vehicle properly and safely.

XPENG always reserves the right to change, supplement, or terminate the contents and technical specifications of this manual.

Please keep the manual safe for future reference.





## 1 Vehicle Specification

Appearance.....	9
Front row.....	12
Rear row.....	15
Trunk.....	17
Front compartment.....	19
High voltage components.....	21
XPILOT-hardware.....	23

## 2 XOS

Interface of central control panel.....	27
Instrument cluster.....	33
Intelligent voice.....	40
User Account.....	44
System update.....	45
Navigation.....	47

Music app.....	48
----------------	----

## 3 All-domain intelligent driving

Environment simulation display SR.....	50
3D vehicle control.....	51
3D charging/discharging.....	51
Driving risk warning.....	55
Forward vehicle start reminder.....	56
Green light starting reminder*.....	57

## 4 Intelligent image

360 AVM.....	59
Narrow lane activation panoramic image.....	62
Steering activation side rear image.....	63



## 5 Driving assist

Adaptive Cruise Control (ACC).....	64
Lane Centering Assist (LCC).....	71
Intelligent Auto Lane Change (ALC).....	77
Speed Limit Assist (SAS).....	83

## 6 Parking assist

Forward/backward radar warning.....	85
Intelligent Parking Assist.....	86
Intelligent Parking-out Assist (AEP).....	91
Straight Line Summons.....	93
Reversing Assist.....	95

## 7 Active safety

Forward Collision Warning (FCW&AEB).....	99
--	----

Blind Spot Detection & Lane Change Assist (BSD&LCA).....	103
Door Opening Warning (DOW).....	105
Rear Collision Warning (RCW).....	107
Rear Cross Traffic Alert (RCTA).....	108
Reverse Collision Prevention.....	110
Lane support systems (LSS).....	112
Traffic Sign Recognition (TSR).....	115
Intelligent High Beam (IHB).....	117
Driver Status Monitor (DSM).....	119

## 8 Safe driving

Safe Use Of Assisted Driving System.....	122
Safety Instructions.....	123
Seat Belt.....	125
Airbags.....	131



Ride with Children..... 136  
Secondary Collision Mitigation (SCM)..... 149  
Alcolock..... 149  
Braking Assist..... 149

## 9 Ingress and egress

I-key..... 154  
Cellphone App Bluetooth key..... 157  
PEPS..... 158  
Flush door handle..... 161  
Electric door opening and closing..... 162  
Trunk opening and closing..... 163  
Welcome mode..... 166

## 10 Comfort driving

A/C operation..... 167

A/C smart mode..... 172  
Air purification..... 173  
Seat..... 174  
Seat heating..... 180  
Seat ventilation..... 181  
Steering wheel heating..... 182  
Adjustment of windows..... 182  
Steering wheel buttons..... 186  
Cup holder..... 189  
Power outlet and data interface..... 190  
Cellphone wireless charger (CWC)..... 193  
Reading light..... 196  
Sun visor and vanity mirror..... 198  
Panoramic moonroof..... 199  
Trunk shade..... 200  
Audio on driver side..... 201



External discharge V2L.....	202
Vehicle loading.....	204
Towing mode*.....	206

## 11 Driving operation

Power on/off.....	215
Automatic anti-glare of interior rearview mirror .....	216
Adjustment of exterior rearview mirror.....	216
Adjustment of steering wheel.....	220
Adjustment of exterior lights.....	221
Wiper operation.....	225
Shift operation.....	226
Driving mode.....	228
Adjustment of brake pedal feedback.....	229
Electronic parking brake (EPB).....	229

AutoHold.....	230
Acoustic vehicle alerting system (AVAS).....	231
Energy recovery.....	232
Braking operation.....	233

## 12 Charging instructions

Opening and closing of charging port cover...235	
Charging operation.....	236
Slow charging schedule.....	239
Charging SOC limit.....	240
Battery preheating at low temperature.....	240
Slow Charging Current Settings.....	242
Temperature control before fast charging.....	243

## 13 Daily maintenance

XPILOT hardware.....	244
----------------------	-----



Opening/closing of front hood.....	244	Rescue protective equipment.....	281
Coolant.....	246	Collision protection.....	282
Brake fluid.....	247	Jump starting.....	282
Windshield washer fluid.....	251	Emergency unlocking of charging port.....	284
Wiper blade.....	253	Electric door emergency opening and closing .....	284
Traction battery.....	255	Emergency opening/closing of trunk.....	287
Charging stand.....	258	Vehicle emergency starting.....	288
Tire.....	258	Emergency power-off.....	288
Brake pad.....	263	Initialization of windows.....	289
Exterior cleaning.....	263	Initialization of seats.....	290
Interior cleaning.....	267		

## 14 Emergency rescue

Emergency devices.....	271
Emergency tire repair.....	272
E-call.....	280

## 15 Vehicle identification

Vehicle type and parameters.....	291
Fluid and capacity.....	300
Label and nameplate.....	301



User information..... 303



## Appearance

### Introduction

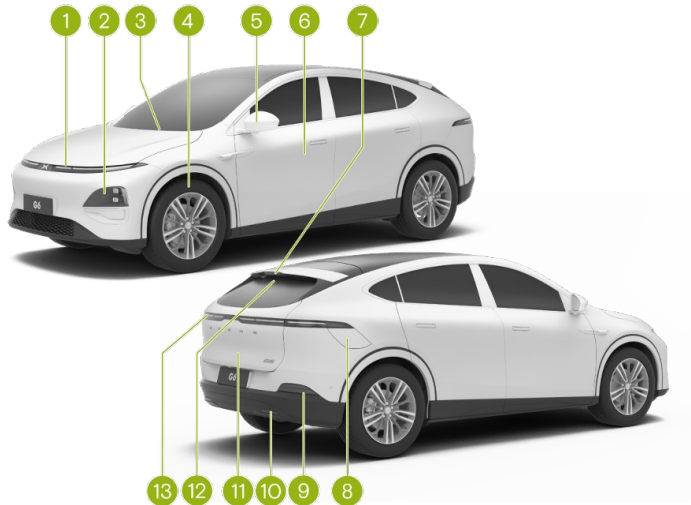



1. Front headlight
  - Daytime running light [See 221 page](#)
2. Front combination light
  - Light operation [See 221 page](#)
  - Follow-me-home [See 221 page](#)
  - Headlight leveling [See 221 page](#)
3. Front wiper
  - Wiper operation [See 225 page](#)
  - Replacement of wiper blades [See 253 page](#)
4. Wheel
  - Tire maintenance [See 258 page](#)
  - Tire specifications [See 295 page](#)
5. Exterior rearview mirror
  - Adjustment of exterior rearview mirror [See 216 page](#)
  - Exterior rearview mirror heating [See 167 page](#)
6. Doors
  - Electric door opening and closing [See 162 page](#)
  - PEPS [See 158 page](#)
  - Electric door emergency opening and closing [See 284 page](#)
  - Flush door handle [See 161 page](#)
7. High-mounted stop light
8. Charging port cover
  - Charging port cover opening and closing [See 235 page](#)
  - Charging operation [See 236 page](#)
  - Emergency unlocking of charging port [See 284 page](#)
  - External discharge [See 202 page](#)
9. Brake light
10. Rear fog light/reversing light
11. Trunk
  - Trunk opening and closing [See 163 page](#)
  - Emergency trunk opening [See 287 page](#)
12. Rear wiper



- Wiper operation [See 225 page](#)
- Replacement of wiper blades [See 253 page](#)

### 13. Tail light



## Front row

### Introduction

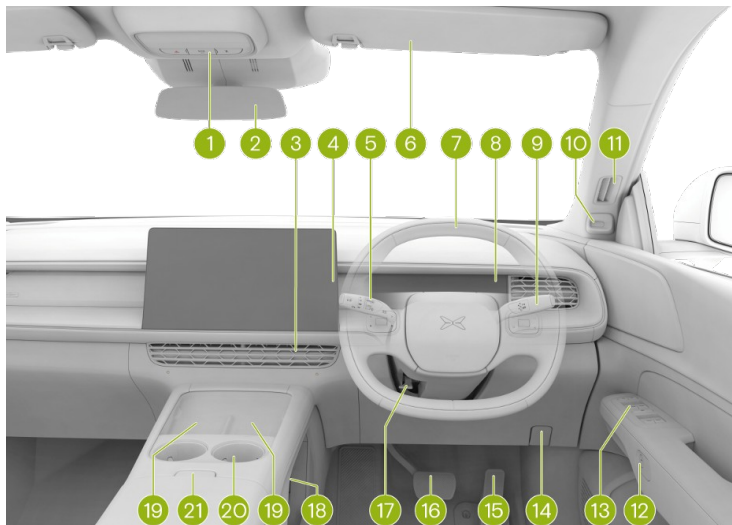



1. Front ceiling light
  - Reading light [See 196 page](#)
  - Hazard warning light [See 271 page](#)
  - E-call [See 280 page](#)
  - Emergency power-off [See 288 page](#)
2. Interior rearview mirror
  - Automatic anti-glare [See 216 page](#)
  - Interior rearview mirror base interfaces [See 190 page](#)
3. A/C air vent
  - Electric adjustment [See 167 page](#)
4. CID
  - CID interface [See 27 page](#)
5. Light & wiper stalk
  - Light operation [See 221 page](#)
  - Wiper operation [See 225 page](#)
6. Sun visor and vanity mirror [See 198 page](#)
7. Steering wheel
  - Steering wheel buttons [See 186 page](#)
  - Horn [See 186 page](#)
  - Driver frontal airbag [See 131 page](#)
8. Instrument cluster module (ICM)
  - Instrument panel interface [See 33 page](#)
  - Instrument panel indicators [See 35 page](#)
9. Shift lever
  - Shift operation [See 226 page](#)
  - Adaptive cruise control (ACC) [See 64 page](#)
  - Lane centering control (LCC) [See 71 page](#)
10. In-vehicle camera
  - Driver Status Monitor (DSM) [See 119 page](#)
11. Side defrost air vent [See 167 page](#)
12. Door electric release switch [See 162 page](#)
13. Door switch group
  - Window switch [See 182 page](#)
  - Door lock switch [See 162 page](#)
14. Front hood opening handle [See 244 page](#)

## Vehicle Specification

---



1

- 15. Accelerator pedal
  - X-pedal [See 232 page](#)
- 16. Brake pedal
  - Adjustment of brake pedal feedback [See 229 page](#)
- 17. Steering wheel unlock lever
  - Adjustment of steering wheel [See 220 page](#)
- 18. Power outlet [See 190 page](#)
- 19. Cellphone wireless charger (CWC) [See 193 page](#)
- 20. Cup holder [See 189 page](#)
- 21. Opening/closing of front central armrest box



## Rear row

### Introduction



# Vehicle Specification

---



1. Ceiling handle
2. Rear reading light [See 196 page](#)
3. A/C air vent
  - Manual adjustment
4. Type-C port [See 190 page](#)
5. Driver seat
  - Seat adjustment [See 174 page](#)
  - Seat heating [See 180 page](#)
  - Seat ventilation [See 181 page](#)
6. Window switch [See 182 page](#)
7. Door electric release switch [See 162 page](#)
8. Door emergency opening handle [See 284 page](#)
9. Rear seat
  - Backrest adjustment [See 174 page](#)
  - Central armrest [See 189 page](#)
  - Backrest inclination [See 174 page](#)
  - Seat heating [See 180 page](#)



## Trunk

### Introduction



# Vehicle Specification

---



1. Trunk external switch
  - Trunk opening and closing [See 163 page](#)
2. Trunk internal switch
  - Trunk opening and closing [See 163 page](#)
3. Trunk light
4. Trunk access cover
  - Emergency unlocking of charging port [See 284 page](#)
5. 12V power outlet [See 190 page](#)
6. Trunk cover
  - Trunk emergency device [See 271 page](#)
7. Trunk shade [See 200 page](#)



## Front compartment

1

### Introduction

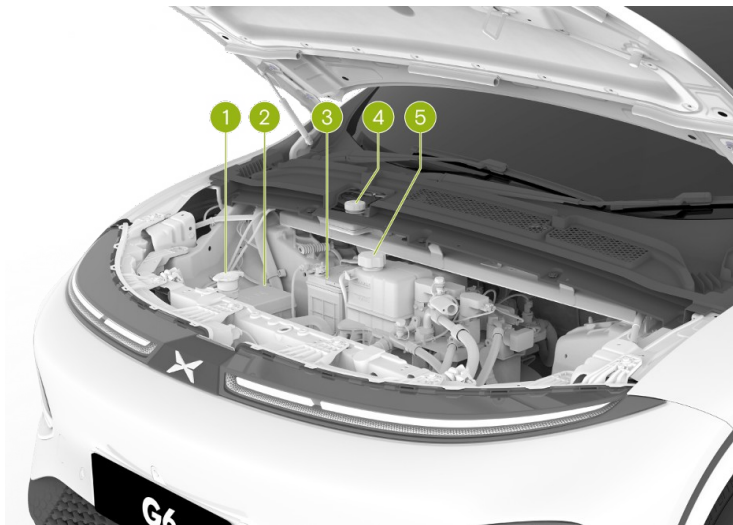

# Vehicle Specification

---



1. windshield washer fluid reservoir
  - Inspection and filling [See 251 page](#)
  - Filling amount [See 300 page](#)
2. Front compartment fuse box
3. Battery
4. Brake fluid reservoir
  - Inspection and filling [See 247 page](#)
  - Type and filling amount [See 300 page](#)
5. Coolant reservoir
  - Inspection and filling [See 246 page](#)
  - Type and filling amount [See 300 page](#)



## High voltage components

### Introduction

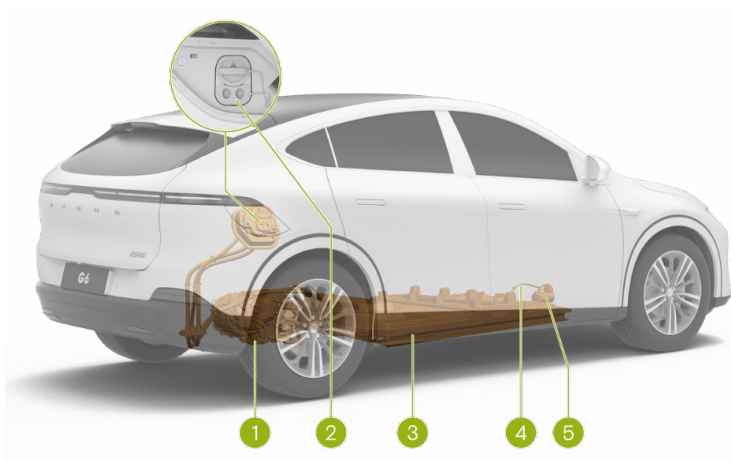



1. Rear electric drive system
  - Type and parameters [See 299 page](#)
2. Charging port
  - Charging port cover opening and closing [See 235 page](#)
  - Charging operation [See 236 page](#)
  - Emergency unlocking of charging port [See 284 page](#)
3. Traction battery
  - External discharge [See 202 page](#)
  - Traction battery maintenance and recycling [See 256 page](#)
4. High-voltage wiring harness
5. A/C compressor



## warning

It is prohibited to touch or disassemble the high-voltage wiring harness or the high-voltage components connected, otherwise, there is a risk of electric shock.



## XPILOT-hardware

### Radar

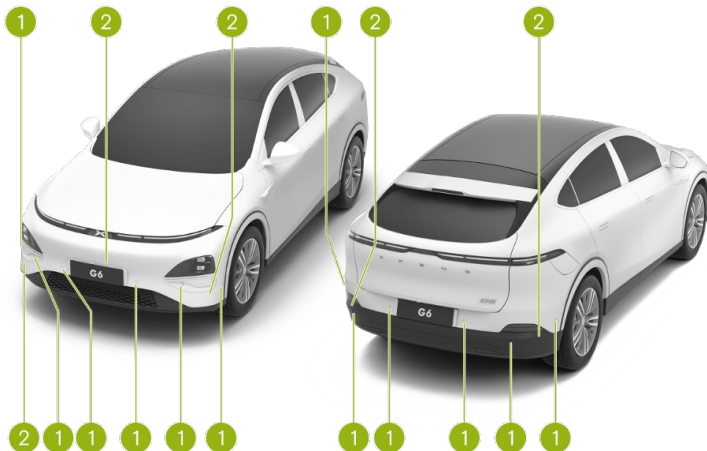

# Vehicle Specification

---



1

1. Ultrasonic radar
2. MMW radar



## Camera

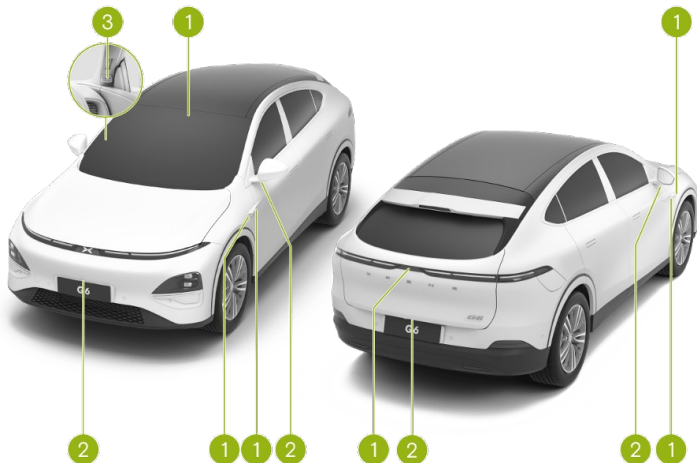



1. High sensitivity camera
2. Surround view camera
3. In-vehicle camera



## **warning**

If the radar and camera functions are limited, the driving assist function will not be activated or work properly.



## Interface of central control panel

### Introduction

The central control panel displays the split screens by default. The to the map navigation interface is displayed on the left [See 47 page](#), and the to the all-domain intelligent driving interface on the right [See 51 page](#).

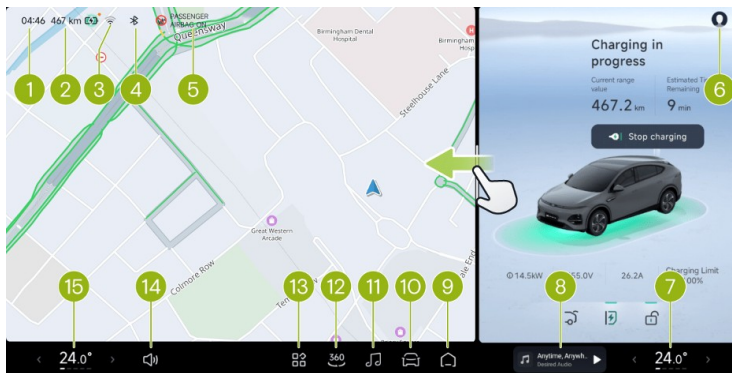



1. Time
2. Traction battery
  - It indicates the current driving range and SOC.
3. Network
4. Bluetooth
5. PASSENGER AIRBAG ON
  - Tap to turn on/off the front passenger airbag disabling function.
6. Account & habit [See 44 page](#)
  - Tap Login to display the account avatar.
  - Set vehicle use habits.
7. Driver's seat A/C components
  - It indicates the current temperature and air volume of the driver's seat A/C.
  - Tap to adjust the A/C [See 167 page](#).
8. Music components [See 48 page](#)
  - It displays the currently playing media cover, media name and play source.
  - Tap to pause or resume music playing.
  - Swipe left or right to play the previous or next song.
9. Homepage
  - Tap to return to the homepage.
  - In the homepage, tap to switch between split screen and full screen.
10. Settings
  - Access to vehicle control setting.
11. Music information [See 48 page](#)
12. 360 Panoramic Image [See 59 page](#)
13. App Center
14. Volume adjustment
15. Front passenger's seat A/C components
  - It indicates the current temperature and air volume of the front passenger's seat A/C.
  - Tap to adjust the A/C [See 167 page](#).

**i Tips**

The font used for XOS is [MiSans].



## Split-screen multitasking

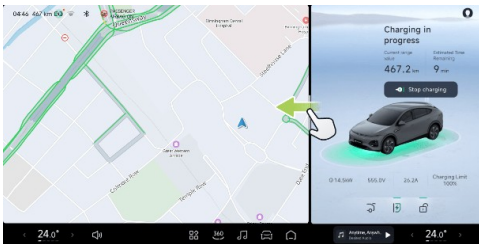

Drag the split screen line to switch between full screen/split screen.

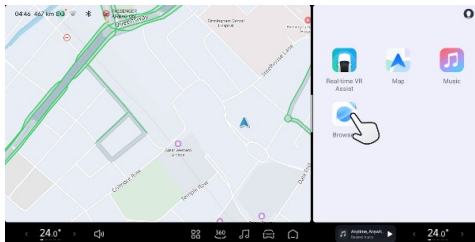
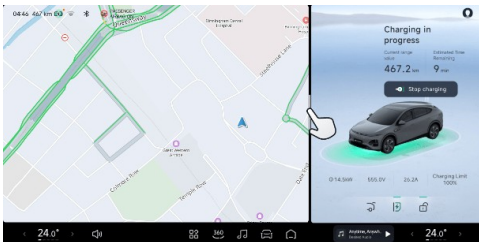

Tap the split screen line to fix the small window mode, in which the all-domain intelligent driving, maps, music and browsers can be displayed.

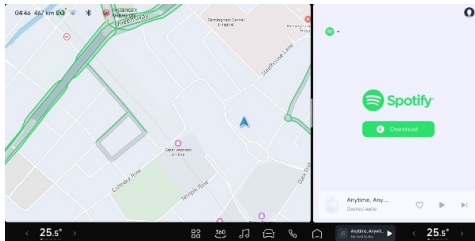

In the split screen mode, different apps can be opened in large windows, allowing, for example, the driver to view the navigation interface and the front passenger to listen to songs and read lyrics simultaneously.

## Gesture interaction

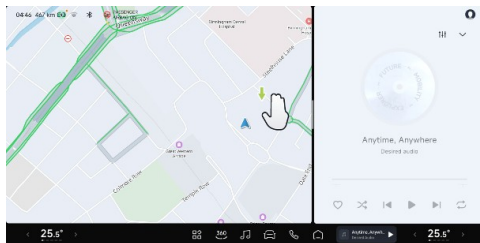

Three-finger swiping down allows exiting the app opened in the large window in the split screen mode and then returning to the corresponding homepage.

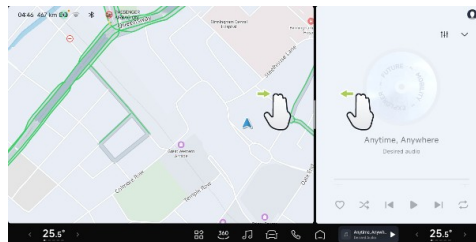

Three-/four-finger swiping left or right allows switch between different app windows. However, it doesn't work in full screen mode.

### **i** Tips

This gesture is invalid for the bottom taskbar area. During the switch, the status bar will be hidden and the bottom taskbar will not be hidden.



## Customized bottom taskbar

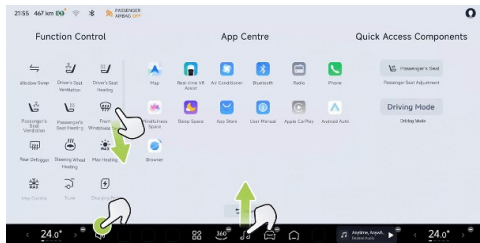

1. To customize the bottom taskbar, tap and hold the bottom taskbar icon or any area of the app list.
2. You can drag the function control, app and shortcut icons in the App Center to the bottom taskbar area.
3. In the custom status, tap  of the upper right corner of the icon or drag the icon to the App Center to release it, and the icon can be removed from the bottom taskbar.

4. Tap the bottom taskbar or the blank space of the app list again to exit the custom status.

## App Center

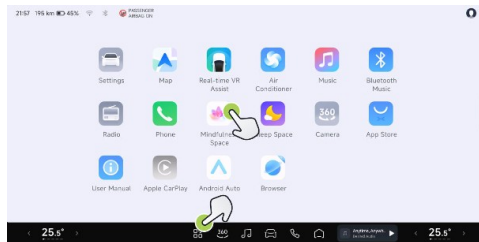

1. Tap the taskbar  at the bottom to open the App Center, and tap any blank space in the App Center to exit quickly.
2. Tap the app icon to open the app. Apps being downloaded and installed also have corresponding status display.
3. Tap and hold the app icon or blank space to enter the custom App Center status. At this

time, you can drag the icon to sort in the app list.

## Shortcut panel

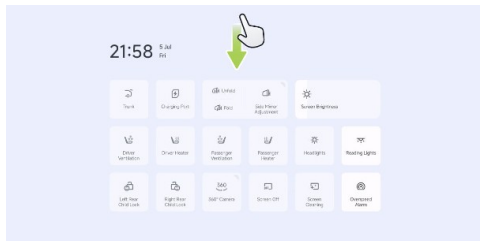

For high-frequency functions, you can operate directly from the shortcut panel without opening the app. Swipe down from the top of the screen to unfold the shortcut panel, and swipe up to fold it. The shortcut panel is folded when you tap on a blank space or open a new screen.



## Instrument cluster

### Introduction

2

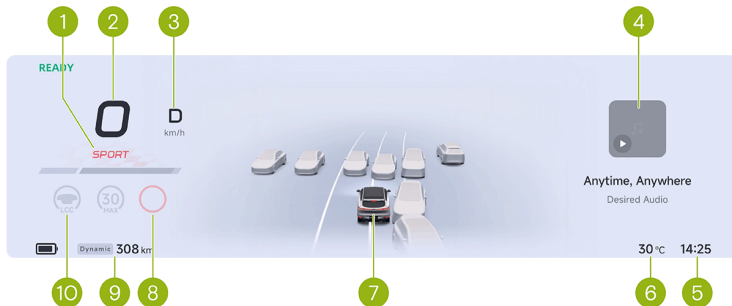

1. Driving mode [See 228 page](#)
2. Vehicle speed
3. Gears [See 226 page](#)
4. Information display area
  - The display information can be switched through the left and right scroll wheels of the steering wheel respectively, and the gear, energy consumption, mileage, navigation and music can be selected.
5. Time
6. Exterior ambient temperature
7. All-domain intelligent driving [See 50 page](#)
  - It displays the vehicle status.



- It displays the simulated vehicle external environment.
8. Speed limit information
- It displays the speed limit information identified by the system.
9. Driving range/SOC indicator
- On the “ → **Charging and Discharging** → **Range Display Settings**” interface of the central control panel, you can switch between WLTP/Dynamic and ON/OFF SOC percentage display.
10. Indicator
- Indicators are distributed at different positions on the instrument panel to reflect the status of vehicle functions.



## Instrument panel indicator

After the vehicle is powered on, some indicators will illuminate. After the system completes self-inspection, if the system is normal, these indicators will go out. Some indicators illuminate to display the current status of vehicle system functions, not a system fault. In case of any doubt in daily use, please contact the XPENG Service Center for consultation.



High beam on



Airbag fault



Intelligent high beam on and the high beam on



Driver seat belt unfastened



Intelligent high beam fault



Front passenger seat belt unfastened



Intelligent high beam on and the high beam not on



Rear left passenger seat belt unfastened



Left turn signal on



Rear middle passenger seat belt unfastened



Right turn signal on



Rear right passenger seat belt unfastened



Low beam on



Speed limit on the speed limit sign



Rear fog light on



Low washer fluid level indicator



Clearance light on



High-voltage system ready and the vehicle in a drivable status



Automatic headlight control on and the low beam on



Battery fault



LSS fault



Coolant temperature too high



Charging cable connected



Powertrain fault



Timed charging ON



Motor and controller overheating



Steering system fault



Motor and controller fault



Normally on: Parking function activated  
Flashing: Incorrect caliper status



Traction battery temperature too low



Normally on: Parking brake fault  
Flashing: Parking system in maintenance mode



Traction battery temperature too high



AUTO HOLD activated



Traction battery SOC too low



AUTO HOLD fault



Traction battery fault



Brake system fault



Traction battery disconnected



Flashing: ESP activated  
Normally on: ESP fault

















Fault in FCW



ESP OFF



FCW OFF

	ABS fault		Too many indicators are lit at the same time, and all the indicator display positions are occupied.
	Braking performance degradation		Driver assistance system fault
	HDC activated		Tire pressure abnormal or tire pressure monitoring system fault
	HDC fault		Doors, engine hood and trunk not all closed
	Driving power limit		LCC activated
	Maximum speed limit of ACC/LCC, and any function activated		LCC can be activated
	Maximum speed limit of ACC/LCC, and both not activated		APA activated



Towing function fault indicator\*



APA can be activated



Normal towing function indicator\*



APA unavailable



Indicator for towing function not activated\*



ACC activated



SAS activation



ACC can be activated

## Intelligent voice

### Voice assistant

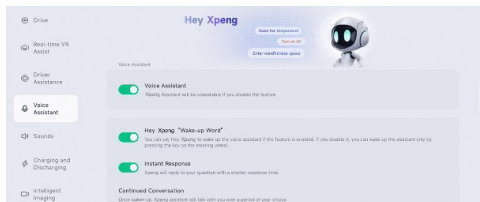

On the “ **Voice Assistant**” interface of the central control panel, you can turn on “**Voice Assistant**” to support functions such as multi-tone zone and continuous dialogue.

#### Tips

Other intelligent voice functions can only be enabled after the “**Voice Assistant**” is turned on.

### Wake-up mode

X-Peng Voice can be woken up in the following ways:

- Voice button on steering wheel
- “**Voice Assistant**”

On the “ **Voice Assistant**” of the central control panel, you can turn on/off the “**Voice Assistant**”. After the function is enabled, add “**Hey X-Peng**” before the command to call the Voice Assistant. For example:

- Hey X-Peng, turn on the A/C.
- Hey X-Peng, navigate home.
- Hey X-Peng, how long will it take to get there?
- Hey X-Peng, play a song.

You can try the following voice commands:

- Lower driver's seat.
- Move my seat backward.
- Turn on massage.



- Turn on reading light.
- Open my window.
- Turn up the heat in my seat.
- Turn on seat ventilation.
- Turn on the steering wheel heating.
- Turn on ac cooling.
- Navigate to...
- Turn on spotify.
- Play some music.
- Turn on bluetooth.

## Dialogue mode

### Instant Response

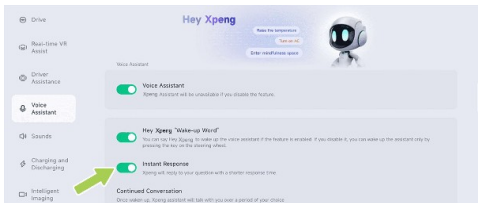

“Instant Response” can be selected in the “ →Voice Assistant” interface of the central control panel. After selection, X-Peng will answer the question in a shorter time each time.

### Continued Conversation

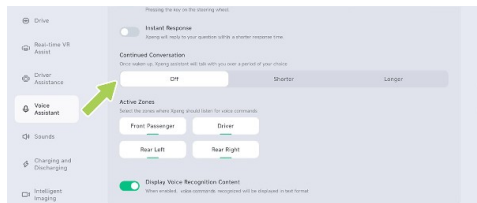

In the “ →Voice Assistant” interface of the central control panel, you can select “Continued Conversation”. After selection, X-Peng can keep listening for a period of time after executing the previous task. At this time, you can directly issue new instructions without repeatedly waking up X-Peng. You can also set how long X-Peng stays listening.

## Display Voice Recognition Content

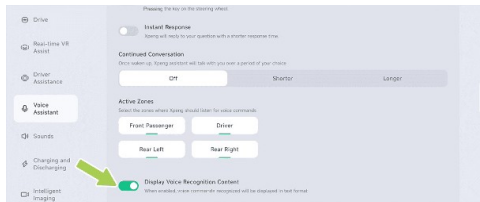

In the “**Voice Assistant**” interface of the central control panel, you can select “**Display Voice Recognition Content**”. After selection, the voice command will be displayed on the central control panel in the form of text.

## Multi-tone zone

The intelligent voice supports the four-zone voice dialogue recognition of the whole vehicle, and each passenger in the vehicle can wake up X-Peng at any time to have a conversation. Through the four-zone sound source positioning and voice separation capability, X-Peng can

accurately distinguish which position gives instructions and provide corresponding services. The conversation between passengers does not interfere with each other.

For example:

- When the driver says “**open the window a little**”, X-Peng can open it a little.
- If the front passenger asks to “**turn on the seat ventilation**”, X-Peng can turn on the front passenger’s seat ventilation.

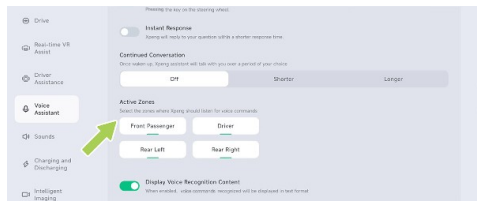

In the “**Voice Assistant**” interface of the central control panel, the audio zone can be closed as required. After closing, the system



will no longer accept voice commands from this audio zone.

## No network conversation

In poor network environments such as underground garage, expressways and tunnels, some conversational services that rely heavily on the Internet (such as playing music) are temporarily unavailable. However, Xpeng can still provide you with basic voice services, including but not limited to the following functions:

- Voice control for A/C
- Voice control for seats
- Voice control for doors and windows
- Voice control for lighting
- Voice control for navigation

## User Experience Addition Improvement Plan

To make X-Peng smarter, we sincerely invite you to join the **“User Experience Improvement Plan for Voice Assistant”**.

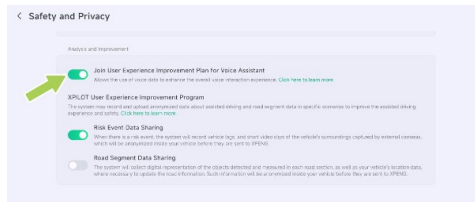

2

On the “**General**→**Safety and Privacy**” interface of the central control panel, you can turn on/off **“Join User Experience Improvement Plan for Voice Assistant”**.

Before enabling this function, you need to read and agree with the User Experience Improvement Plan for Voice Assistant. After this function is enabled, the system can collect voice usage information to improve your voice interaction experience.

## User Account

### Introduction

You can log in, log out and switch accounts by tapping the avatar in the upper right corner of the central control panel.

### Operation

#### Login account

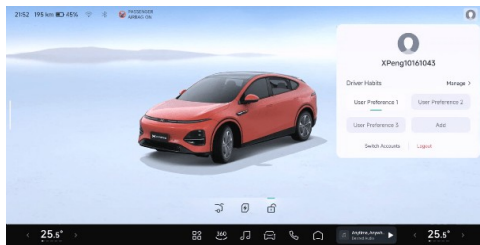

Tap the default avatar (not logged in) in the upper right corner of the central control screen, and scan the QR code with your mobile App to log in. After successful login, all account memory

settings of the account will be automatically synchronized to the current vehicle.

Tap the avatar, and an account floating window will be displayed to select the habits you want to use. The habits of every user, including driver's seat position and rearview mirror position will be memorized. At the same time, tap “+ Add” to create a new habit. Up to 6 habits can be created.

Tap “**Manage habits**” and tap and hold the habit you want to edit to change the name of the habit or delete it.

#### Switch account

In the account floating window, tap “**Switch Account**” and scan the QR code with your mobile App to switch accounts.

#### Log out

In the account floating window, tap “**Logout**” to log out of the current account.



### **i** Tips

After logging out the account, you can still use most functions of the vehicle, but the memorized habits will not be available. If you want to use functions such as the driver assistance system, you need to log in with your account.

## System update

### Introduction

The vehicle can be updated remotely through the central control panel or mobile APP to obtain the latest functions. It is recommended that you update the system as soon as possible after receiving the new version prompt.

### **i** Tips

- Make sure that the vehicle is connected to the Internet. The update push will not be received until the vehicle is connected to the network.

- If you have any other questions, please contact XPENG Service Center or Customer Service Center.

### System version



On the “**General**” interface of the central control panel, tap the “**XOS version number**” on the top to view the details of the current IVI version.

### Update settings

Tap “**Update Settings**” to enable the “**Auto Update**”. When vehicle detects a new update later, it will automatically update at 3:00 am without manual confirmation.

### Tips

It is recommended to enable the “**Auto Update**” function to keep the vehicle system up-to-date at all times.

### Update method

When a new version is available, the system will push a notification to remind you that there are new versions for update. The “**new version**” icon will be displayed in the “**System Update**” bar, and the system update icon  will appear in the top status bar of the central control panel.

Tap the update icon  in the status bar of the central control panel or tap the “**System Update**” bar to view the update description of the new version.

When there is a new version to be updated, the system can be updated in the following two ways:

#### Reserve Update

On the update instruction page of the new version, tap “**Reserve Update**” to set the time

when you do not need to use the vehicle. Tap “**OK**”, and the system will be updated when the vehicle is locked at the set time.

After the reservation is updated, the system update page will display the reservation information. Before the update starts, you can tap “**Cancel the reservation**” at any time and reserve another system update time.

#### Remote Update through Mobile App

The vehicle supports remote system update with “**Xpeng App**”. When there is a new update, the App will send a message notification and display a “**New Version**” icon on the upper left of the central control panel. Tap the card button or the “**New Version**” icon to enter the remote system update interface, and tap “**Update Now**” to complete the update.

#### Cautions and Limitations

- The vehicle cannot be used during system update. Please ensure that the vehicle is



locked and parked in a safe area, and wait patiently for the update to complete.

- The vehicle cannot be charged during updating. Please arrange the time for updating and charging reasonably.
- System update failure may cause some functions to be abnormal. If the update fails, do not use the vehicle. Tap **“Retry”** to retry the update. If retrying for many times fails, please contact XPENG Service Center or Customer Service Center.
- Once updated, the system cannot be reverted to previous versions.

## Navigation

### Seamless navigation

#### Introduction

Seamless navigation can be achieved by sending an address to the vehicle from your mobile phone and promptly starting navigation after logging in and binding the mobile App.

#### Operation

Taking Xpeng APP as an example, seamless navigation can be realized through the following operations:

1. Tap the **“Xpeng→search box”** on the mobile App interface in turn to set the navigation destination.
2. Tap **“Send to Vehicle”** to send the destination information to the central control panel of the vehicle.
3. After the central control panel receives the navigation information sent by the mobile phone, a confirmation card will pop up. Tap **“OK”** to realize seamless navigation.

### Charging planning

For long-distance travel, the system can automatically plan driving and charging routes according to charging preference.

1. On the map interface of the central control panel, tap **“Map Settings”** to adjust the minimum SOC separately for arrival at the

charging station and the destination in the “**Charging Route Preference settings**”.

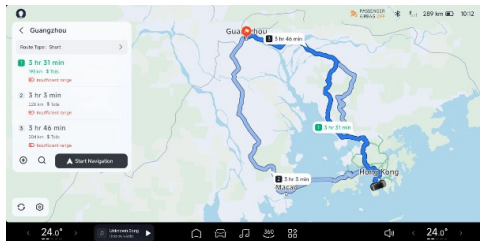

2. Tap “**Charging**” on the route planning interface to enter the intelligent charging planning interface. The system will automatically plan charging stations along the way, and display information such as charging station information, driving interval distance, recharging times and time length. Tap “**Start Navigation**” to start the journey.

### i Tips

If the current SOC is sufficient to reach the destination, charging stations will not be added automatically.

3. During driving, the distance to charging station and estimated arrival time will be updated dynamically. When the vehicle is about to arrive at the charging station, a voice reminder will be given.

## Music app

### Introduction

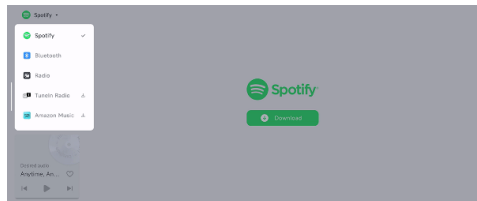



Xpeng provides customized music apps, supporting Spotify, Bluetooth, TuneIn Radio, Radio and Amazon Music.

Tap the taskbar “🎵” at the bottom of the central control panel, and switch and play the audio source at the audio source entrance in the upper left corner of the music interface.

## Radio

The vehicle supports FM/AM, and even DAB in some regions.

- Switch the audio source to “**Radio**” to play local radio stations.

## Bluetooth music

Switch the audio source to “**Bluetooth**”, tap “**Connect Bluetooth**” to connect the mobile phone Bluetooth, and then you can listen to songs from the mobile phone in the car.



## Environment simulation display SR

### Introduction

SR can simulate and display the current day/night effect and traffic environment around the vehicle on the instrument panel and central control panel.

### SR interface of instrument cluster

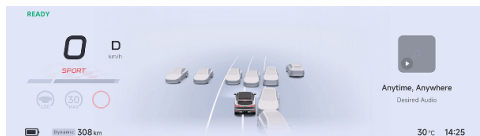

### SR interface of central control panel



3

The SR interface includes the following functions:

- 3D central control panel [See 51 page](#)
- 3D charging/discharging [See 51 page](#)
- Driving risk warning [See 55 page](#)
- Forward vehicle start reminder [See 56 page](#)
- Green light starting reminder\* [See 57 page](#)

#### warning

SR is only a driver assistance function. As the driver of the vehicle, you are responsible for driving safety. Do not rely on this function to control the vehicle; otherwise, injury or even death may be caused.



### Warnings, Cautions and Limitations

#### warning

SR cannot work normally in the following scenarios:

- Camera limitations [See 122 page.](#)
- The vehicle is running on a road with large curves or poor road conditions.

The above warnings, cautions and limitations do not cover all conditions that may affect the normal operation of SR.

### 3D vehicle control

#### Introduction

When the vehicle is in P gear, tap the icon below the 3D model on the central control panel or directly tap the hotspot on the model to open/close the trunk, open/close the charging port cap or unlock/lock the vehicle (only icons available).



3

### 3D charging/discharging

#### Introduction

When the charging plug or external discharge equipment is connected with P gear engaged, the all-domain intelligent driving interface on the central control panel will display the charging/discharging status, indicating the charging/discharging progress and key information.

#### Tips

- For specific vehicle charging operations, please refer to the "Charging instructions" [See 237 page.](#)

# All-domain intelligent driving



- For the specific operation of external discharge of the vehicle, please refer to the of V2L discharge [See 202 page](#).

## Charging

### Preset charging

The 3D charging interface displays information such as preset charging start time and current driving range.

- Tap “**Charging Limit**” below the model to go to the “**Charging and Discharging**” page to customize “**Charging Limit**” [See 237 page](#). You can also select “**Optimal**”, and the system will set the optimal charging limit according to the current traction battery status.

#### **i** Tips

It is recommended to use the optimal charging limit recommended by the system, and the charging speed will be faster.

- Tap “**Current**”, “**Voltage**”, “**Power**” to pop up the charging curve window.

- Tap “**Start Charging**” to get ready for charging.

### Ready for charging



In charging preparation, the system will wait for the response of the charging pile; if the battery temperature is low, it may affect the charging power. At this time, the battery will be heated first, and the “**Heating status of the battery**” will be displayed briefly, and charging will start automatically after heating.



## All-domain intelligent driving

### Normal charging



For ordinary charging, the interface displays charging information such as Current Endurance Mileage, Estimated Time Remaining, Enter Range Value, Power, Voltage, Current and Charging Limit. Tap “**Stop charging**” to finish the charging.

### Charging fault

If a fault occurs during charging, the charging interface will pop up the cause of the charging fault and operation suggestions.

### warning

If there is a fault prompt, do not try to charge again, and contact XPENG Service Center immediately.

### Charging completed

After charging is completed, the interface displays charging information such as current driving range, charging duration and new driving range.

### Discharging

#### External discharge in preparation

When the conditions are met (vehicle unlocking & battery power exceeding the power supply limit), insert the power plug to directly start supplying power outward.



- Tap **“Power Limit”** at the bottom of the model to customize **“Power Limit”** on the **“Charging and Discharging”** page.

## **i** Tips

The minimum limit for external discharge of the vehicle is 20% SOC of the traction battery.

- Tap **“Current”**, **“Voltage”**, **“Power”** to pop up the discharging curve window.

## External discharge in progress

The 3D discharging interface displays charging information such as current driving range,

discharged electricity, reduced driving range, power supply limit, current, voltage and power.

Tap **“Stop Supply”** to complete the discharge.

## External discharge fault

If a fault occurs during external discharge, the fault cause and operation suggestions will pop up on the interface.

### **⚠ warning**

If a fault prompt appears, do not retry external discharge. Please contact XPENG Service Center immediately.

## External discharge stopped

- When the power supply limit is reached, the system stops the external discharge. If you want to continue to supply power at this time, you need to reset the power supply limit and tap **“Start Supply”**.
- If you want to continue to supply power after tapping **“Stop Supply”**, you can directly tap **“Start Supply”**.



### i Tips

If the power supply limit reaches 20% SOC of the traction battery, external discharge cannot continue.

## Driving risk warning

### Introduction



When the driver assistance system is not turned on and the vehicle is in D gear, if the surrounding dynamic obstacles are close to the vehicle or there are potential safety risks, the SR interface will give a warning.

The medium-risk obstacle warning will turn red, and the high-risk one will also turn red with a sound prompt.

### Warnings, Cautions and Limitations

The driving risk warning is only used for warning, and the driver has the responsibility to observe the surrounding environment and make decisions accordingly.

#### warning

The driving risk warning may not be triggered in the following cases. Including but not limited to:

- Radar or camera limited [See 122 page](#).
- The vehicle is running on a road with large curves.
- When the vehicle is running on a road with poor conditions.

The above warnings, cautions and limitations do not cover all situations that affect the normal operation of driving risk warning.



## Forward vehicle start reminder

### Introduction

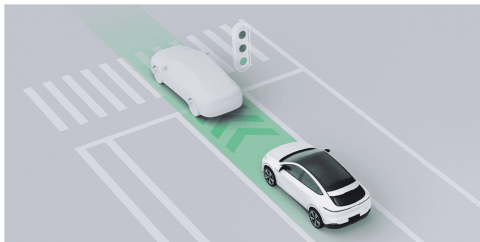

When the driver assistance system is not turned on and the vehicle is in D gear, if it is on a congested road section, after the vehicle ahead has traveled for a certain distance, the SR interface will display the animated effect to remind the driver to start.

## Warnings, Cautions and Limitations

### warning

In the following cases, the forward vehicle start reminder may not be triggered, including but not limited to:

- There are pedestrians, bicycles and motorcycles ahead.
- There is no vehicle ahead.
- The vehicle is not in D gear.
- The vehicle speed is greater than 0 km/h.
- The distance between the front vehicle and this vehicle is large.
- The vehicle ahead and the vehicle are stationary for a short time.

### warning

In certain cases, the forward vehicle start reminder will be suppressed, including but not limited to the following situations:

- Poor visibility at night.



## All-domain intelligent driving

- Poor visibility caused by bad weather (such as heavy rain, snow, fog and dust).
- Strong light, backlighting, water reflection and extreme light contrast.
- Camera limitations [See 122 page](#).

The above warnings, cautions and limitations do not cover all conditions that affect the normal operation of forward vehicle start reminder.

### Green light starting reminder\*

#### Introduction

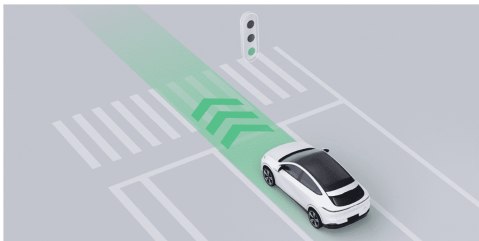

When the driver assistance system is not turned on and the vehicle is in D gear, if the traffic light turns green during stopping and waiting and the vehicle is not started, the SR interface will display the animated effect of green light starting, and at the same time give a prompt sound to remind the driver to start.

#### Warnings, Cautions and Limitations

##### warning

In the following cases, the green light starting reminder may not be triggered, including but not limited to:

- The system does not recognize the traffic light information.
- There are vehicles or non-motor vehicles and pedestrians ahead.
- The vehicle is not in D gear.
- The vehicle speed is greater than 0 km/h.



The green light starting reminder will be suppressed under certain circumstances, including but not limited to the following:

- Poor visibility at night.
- Poor visibility caused by bad weather (such as heavy rain, snow, fog and dust).
- Strong light, backlighting, water reflection and extreme light contrast.
- Camera limitations [See 122 page.](#)

The above warnings, cautions and limitations do not cover all conditions that affect the normal operation of the green light starting reminder.



## 360 AVM

### Introduction

The 360 panoramic image system captures the surrounding environment of the vehicle through the surround view cameras around the vehicle and displays the environment on the central control panel.

The surround view cameras are installed above the license plate and below the left and right exterior rearview mirrors respectively [See 25 page](#).

The 360 Panoramic Image can be accessed through the following ways:

- X-Peng voice
- Central control panel
  - “360° Panoramic Image ”of App Center“
  - 360° Panoramic Image of the bottom taskbar.
- Steering wheel shortcut key

#### caution

Objects in the AVM screen and real objects will be deformed to some extent.

#### warning

AVM is only a driver assistance function and cannot cope with all traffic, weather and road conditions. As the driver of the vehicle, you are responsible for driving safety. Do not rely on this function to control the vehicle; otherwise, injury or death may be caused.

4

### Operation

#### 2D mode image

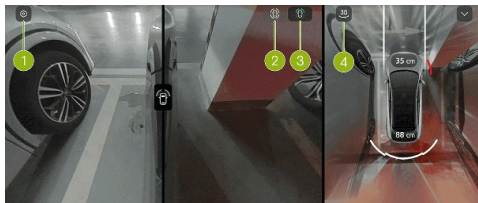



## 1. Image setting

Tap “” to jump to the “**Intelligent Imaging**” page, where you can set image-related functions.

2. Front and rear left and right hub views in 2D mode.
3. Front left and right hub views in 2D mode.
4. 3D/2D mode switching.

## Image of shifting to D gear

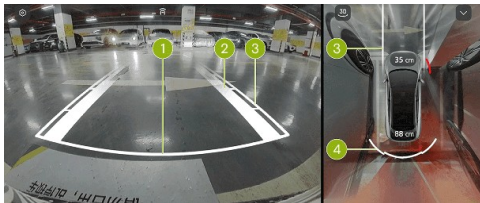

### 1. Safety stop line

- It indicates the position about 0.3 m behind the vehicle.

### warning

When the safety stop line contacts an obstacle, please stop reversing.

### 2. Tire track surface

- It indicates the driving route of wheels.

### 3. Dynamic auxiliary line

- The width of the vehicle is indicated by two thin white lines.
- In the front/rear view, segmented scale lines are used to indicate the distance between vehicles and objects.
- The distances indicated by each scale line from near to far are about 0.6m, 1m and 1.5m respectively.

### 4. Radar warning

- It simulates display according to the distance and direction of obstacles.
- When white is displayed, the distance is long.





- When red is displayed, the distance is very close.
- The distance between the vehicle and the nearest obstacle will also be displayed as a numerical value in front of and behind the vehicle respectively.

### 3D mode image



- After the system is switched to the 3D mode, it will integrate the 3D virtual model into the real environment image.
- You can swipe the right model ring  around or directly swipe the left model to achieve free 360° rotation.

- If there is no operation on the screen within 5 seconds, the circle and icon will be automatically hidden. Tap the top view area to display the circle and icon again.
- Tap “” on the current interface to enable “**3D Transparent Body**”, and the 3D virtual model will be switched to the transparent status for direct observation of road conditions under the chassis.
- Tap “” on current interface to enable “**Transparent Chassis**”. When the vehicle is running at a low speed, the right top view will be switched to transparent chassis, and the virtual model will be superimposed on the image of real road surface for easier observation of collision risk around the body.

#### **caution**

Objects in the display may be deformed compared to actual objects.



## ⚠ warning

Transparent chassis and 3D transparent car body are only used to assist in observing the vehicle bottom during parking and driving. Do not rely on this function completely.

## Reversing image hold of shifting to R gear

The “**Reversing Image Hold**” can be turned on/off on the “**🚗 → Driver Assistance → Parking**” interface of the central control panel.

When the function is activated and the gear is shifted from R to D, the 360 image will be switched to the front view. When the gear is shifted to P or the vehicle speed exceeds 10 km/h, the 360 image will exit automatically.

## Narrow lane activation panoramic image

### Introduction

When the vehicle is in D gear and the speed is less than 15 km/h, if obstacles are detected on

both sides of the front and rear of the vehicle, the narrow road auxiliary image will be turned on to assist driving.

## Operation

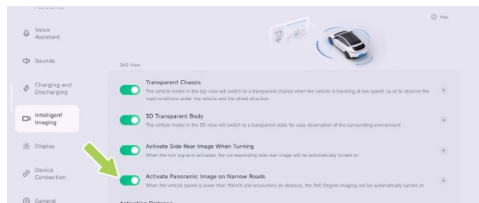

On the “**🚗 → Intelligent Imaging**” interface of the central control panel, you can turn on/off “**Activate Panoramic Image on Narrow Roads**” and select different sensitivity levels according to your driving habits.

### i Tips

- Trigger range: close about 50 cm, medium about 60 cm and far about 75 cm.



## Steering activation side rear image

### Introduction

When the vehicle is not in R gear, when the turn signal is turned on, the rear image of the corresponding side will be automatically turned on for the driver to view the rear blind spot on the side and assist driving.

#### **i** Tips

This function is unavailable during autonomous driving.

### Operation

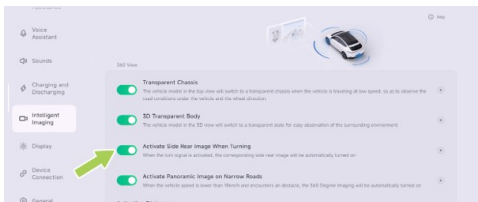

You can turn on/off the “**Activate Side Rear Image When Turning**” on the “**🗨️ → Intelligent Imaging**” interface of the central control panel.



## Adaptive Cruise Control (ACC)

### Introduction

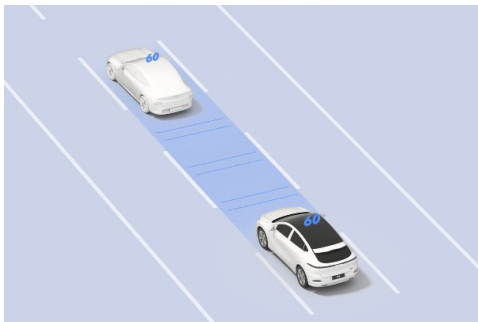

ACC can control the vehicle to follow other vehicles as per the set distance. If the vehicle ahead stops, your vehicle can stop following. If the vehicle ahead starts within 90 seconds, your vehicle can start to follow. If there is no target ahead for following, the vehicle will start and run at the set maximum cruise speed.

ACC also has adaptive turn cruise (ATC) function. ATC obtains the curvature of the road ahead through the camera. When ACC is turned on and the vehicle follows the lane line or the front vehicle turns, ATC improves the turning comfort and stability by adjusting the speed.

#### **i** Tips

When the ACC controls the vehicle to actively decelerates to keep a distance from the vehicle ahead, the brake light will light up; when ACC controls the vehicle to actively accelerates, the accelerator pedal will not move.

#### **⚠** warning

ACC is only a driver assistance function and cannot cope with all traffic, weather and road conditions. As the driver of the vehicle, you are responsible for driving safety. Please hold the steering wheel at all times, observe the road conditions and take control in time in case of danger. Do not rely on this function to control



the vehicle; otherwise, injury or even death may be caused.

### Instrument panel indicator



ACC can be activated when the ACC activation conditions are met.



ACC activated.



Maximum speed limit of ACC/LCC, and any function activated.



Maximum speed limit of ACC/LCC not activated.



System is faulty.

### Operation

#### Activate ACC

When ACC can be activated, the indicator  on the instrument panel will illuminate.



Pull the gearshift lever downward to the end once to activate ACC, and the  on SR interface will illuminate, with a voice prompt.



## **i** Tips

ACC can be activated when the following conditions are met:

- ACC-related components function normally and have a clear view.
- The wiper is not in HI mode.
- Brake pedal is not depressed.
- The vehicle speed meets the requirements:
  - The vehicle speed is 30~150 km/h (without a forward vehicle) or 0~150 km/h (with a forward vehicle and at least 2 m from the forward vehicle).
- There are no safety risks, including but not limited to:
  - Fasten the seat belt correctly.
  - Hold the steering wheel tightly with both hands.
  - All doors are closed.
  - The tire pressure is normal.

- ABS, AEB and other functions not activated.
- No drowsiness driving.

ACC cannot be activated if any of the above conditions is not met.

## **Set the maximum cruise speed**

When ACC is activated, the maximum cruise speed can be set through the left scroll wheel on steering wheel or SAS [See 83 page](#).



When the scroll wheel is rolled slowly, the maximum change rate of cruise speed is 1 km/h; when it is rolled fast, the maximum change rate is 5 km/h.

Alternatively, depress the accelerator pedal. After the vehicle speed increases, pull down and hold the gearshift lever to set the current vehicle speed as a new cruise speed. If you do not pull up and hold the gearshift lever but release the

accelerator pedal, the vehicle will decelerate to the previously set speed and continue cruising.

### Tips

Cruise speed setting range: 30~150 km/h.

### Set the following distance

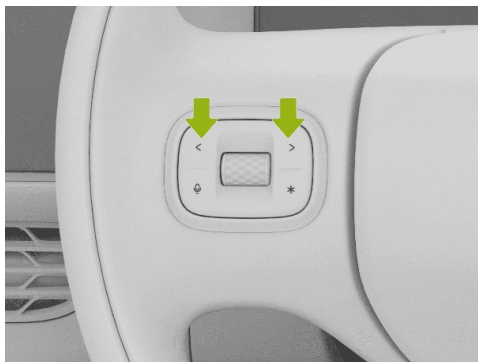

When ACC is activated, the following distance can be set when the left/right button on the left



side of the steering wheel is pressed. There are 5 gears for selection.

### Tips

When the following distance is set, the instrument cluster will display the gear of distance.

### Alarm and take control

#### warning

- If the vehicle sends a control request through SR interface, voice broadcast or other means, you shall take the control immediately.
- If any danger is found or there is a scenario that requires your control, take the control immediately, instead of waiting for the vehicle to send out a control request.

When ACC is activated, you can take the control by the following methods:

- Depress the accelerator pedal: The vehicle speed is temporarily controlled. After the

vehicle speed increases, pull down the gearshift lever to set the current speed as a new cruise speed; or release the accelerator pedal and the vehicle will decelerate to the previously set speed and continue cruising.

- Depress the brake pedal: ACC is deactivated and the vehicle decelerates.
- Pull up the gearshift lever: ACC is deactivated and energy recovery will slow down the vehicle.

In addition, when ACC is activated, if the ACC activation conditions change from satisfied to unsatisfied, ACC will exit. Please take the control.

### Warnings, Cautions and Limitations

Please read all chapters related to ACC in this manual, and you should understand these restrictions before using the functions.

ACC is designed for driving comfort and convenience, not as a collision warning or avoidance system. The driver has the responsibility to stay vigilant at all times, ensure



driving safety and control the vehicle. Do not rely on the system to reduce the vehicle speed sufficiently to avoid collision. Be sure to observe the road conditions ahead and be ready to take corrective measures at any time; otherwise, serious injury or even death may result.

It is your responsibility to determine and always keep a safe following distance. Do not rely solely on ACC to maintain an accurate or suitable following distance.

### **warning**

ACC is a driver assistance function and cannot cope with all traffic, weather and road conditions. Do not use or turn on ACC in the following scenarios:

- Roads with twists or sharp turns and other variable road conditions (such as S-turn, continuous U-turn).
- Roads in poor conditions, such as icy or slippery roads.

- Poor weather conditions, such as heavy rain, snow and fog.
- Urban roads.

### **warning**

ACC cannot fully respond in the following special road conditions, complex road sections, poor weather or poor light environment. Please pay attention to the environment and road conditions, raise vigilance, always put your hand on the steering wheel and take control of the vehicle at any time, including but not limited to:

- Other vehicles suddenly move or close to the front of your vehicle.
- When only part of the body of a vehicle in the adjacent lane move to the front of this vehicle (especially large vehicles such as buses and trucks).
- The vehicle ahead suddenly decelerates.
- There is a U-turn or crossing vehicle.



- When you drive in a tunnel or at night, there are trucks and buses on the side lane, or you follow a vehicle carrying extra-long goods.
- When multiple vehicles are running in parallel when approaching or turning on a road.
- For stationary vehicles or objects (such as road obstacles), especially when the front vehicle leaves your driving lane and a stationary vehicle or object appears ahead.
- The vehicle is running on a slope.
- When you increase the driving speed when going downhill, and when the vehicle exceeds the set speed or road speed limit.

### warning

ACC cannot fully identify and respond to the following environments and targets. Please pay attention to the environment and road conditions. In case of the following scenarios, please actively take control of the vehicle in time to ensure safe driving, including but not limited to:

- The vehicle encounters the following targets ahead, including but not limited to:
  - People, animals.
  - Traffic lights.
  - Walls, barricades.
  - Bicycles (bikes, motorcycles, electric vehicles, etc.), tricycles.
  - Other non-vehicle objects.
  - Targets in the sensor blind zone.
- Vehicles or objects on the other side of the ramp.
- When encountering a vehicle running in an opposite direction.
- The vehicle ahead is equipped with objects beyond its body.
- Construction, accident and other road sections.

The above warnings, cautions and limitations do not cover all conditions that may affect the normal operation of ACC.



### Lane Centering Assist (LCC)

#### Introduction

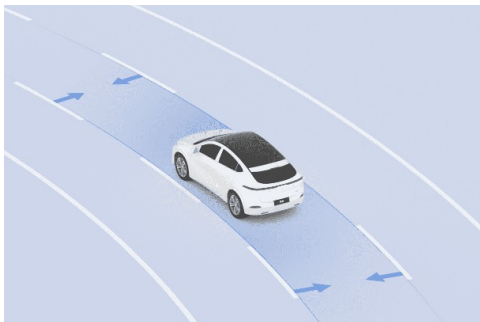

LCC is a comfortable driver assistance function, which can assist the driver to control the steering wheel and keep the vehicle centered in the current lane to the greatest extent.

When LCC is activated, ACC will be activated synchronously. The longitudinal speed and distance are controlled by ACC. LCC assists the

driver in controlling the steering wheel to keep the vehicle centered within the current lane to the greatest extent on a straight road with clear lane lines on both sides and a standard curvature road.

#### **i** Tips

- When LCC is activated, ALC can be used to assist lane change [See 77 page](#).
- When LCC is activated, the cruising speed and following distance can be set through buttons on the steering wheel. The operation method is the same as that of ACC [See 64 page](#).

#### **⚠** warning

LCC is only a driver assistance function and cannot cope with all traffic, weather and road conditions. As the driver of the vehicle, you are responsible for driving safety. Please hold the steering wheel at all times, observe the road conditions and take control in time in case of danger. Do not rely on this function to control

# Driving assist



the vehicle; otherwise, injury or even death may be caused.

## Instrument panel indicator



LCC can be activated when the LCC activation conditions are met.



LCC activated.



The LCC will exit with a delay.



System is faulty.

## Operation

### Opening and closing

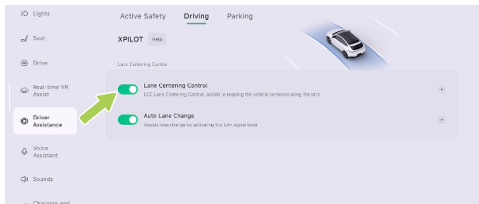

On the “ → **Driver Assistance** → **Driving**” interface of the central control panel, you can turn on/off Lane Centering Control.

### Activate LCC

When LCC can be activated, the indicator on the instrument panel will illuminate.



Pull the gearshift lever downward to the end twice to activate LCC, and the  on SR interface will illuminate, with a voice prompt.

### Tips

LCC can be activated when the following conditions are met:

- LCC-related components can work normally and provide a clear view.
- The lane line is clear.
- The wiper is not in HI mode.
- Brake pedal is not depressed.
- Vehicle speed meets the requirements: The vehicle speed is 30~150 km/h (without a forward vehicle) or 0~150 km/h (with a forward vehicle and at least 2 m from the forward vehicle).
- There are no safety risks, including but not limited to:
  - Fasten the seat belt correctly.
  - Hold the steering wheel tightly with both hands.
  - All doors are closed.
  - The tire pressure is normal.
  - ABS, AEB and other functions not activated.
  - No drowsiness driving.



LCC cannot be activated if any of the above conditions is not met.

## Alarm and take control

### warning

- If the vehicle sends a control request through SR interface, voice broadcast or other means, you shall take the control immediately.
- If any danger is found or there is a scenario that requires your control, take the control immediately, instead of waiting for the vehicle to send out a control request.

For the method of adjusting cruise speed and following distance by LCC, please refer to the descriptions in “**Set the Maximum Cruise Speed**” and “**Set the Following Distance**” under ACC.

When the LCC is activated, you can take the control by the following methods:

- Turn the steering wheel: temporarily control the steering wheel, and after the vehicle is changed to a new lane, LCC can be automatically reactivated.
- Depress the accelerator pedal: temporarily control the vehicle speed.
- Depress the brake pedal: ACC and LCC will exit.
- Pull up the gearshift lever: ACC and LCC will exit.

In the following scenarios, LCC will be downgraded to ACC. please get ready to take control of the vehicle:

- The lane line is not clear.

If the current vehicle status does not meet the ACC activation conditions, LCC will exit directly.

## Warnings, Cautions and Limitations

Please read all the contents about LCC in this manual, and you should understand these restrictions before using the function.



LCC is designed for driving comfort and convenience, and cannot cope with sudden dangerous situations. The driver has the responsibility to stay vigilant at all times, ensure driving safety and control the vehicle. Do not rely on the system to deal with sudden emergencies. Be sure to observe the road conditions ahead and be ready to take corrective measures at any time; otherwise, serious injury or even death may result.

### warning

LCC cannot cope with all traffic, road conditions and weather. Please do not use or turn on LCC in the following scenarios:

- Roads with twists or sharp turns and other changeable road conditions.
- At the merging or diverging points of roads.
- Constructed or modified roads.
- When the lane line disappears or is discontinued.

- When the lane line is blurred, disappears or is covered.
- Roads with sharp changes in the direction of the lane line ahead, such as road diversion, lane merging and sudden increase or decrease of lane width.
- Roads in poor conditions, such as bumpy, icy or slippery roads.
- Urban roads.
- At a traffic intersection.
- When the vehicle ahead turns or there is a vehicle passing through in front of this vehicle.
- Road sections where pedestrians or cyclists may be present.
- When the weather is bad, such as rain, snow and fog.
- When the vehicle is in poor conditions, such as abnormal four-wheel alignment and abnormal tire pressure.



## warning

LCC cannot fully respond in the following special road conditions, complex road sections, poor weather or poor light environment. Please pay attention to the environment and road conditions, raise vigilance, always put your hand on the steering wheel and take control of the vehicle at any time, including but not limited to:

Special road conditions or complex sections:

- On inclined roads, or uphill and downhill sections.
- High-speed turning or sharp turning section.
- There are scenarios of road barriers/curbs/zebra crossings/arrows at intersections.
- There are no lane lines or the lane lines are excessively worn, blocked, covered or disappeared.
- The road markings are temporarily adjusted or change rapidly (such as lane diverging,

crossing or merging) due to road construction.

- Special lane change scenarios such as lane diversion, diverging, diversion area and lane widening.
- There are words or traffic signs on the road surface, or there are dense words, traffic signs, asphalt oil, brake marks, tire prints, ruts and other disturbing objects in the lane.
- The lane is too wide or narrow.
- Road boundary separated by traffic cones, water filled barriers and cement piers.

Complex road conditions:

- When driving on a congested road.
- Roads where pedestrians or cyclists may be present.
- When other vehicles pass in front of your vehicle.
- Suddenly, a vehicle changes lane and runs to the front of your vehicle with little distance.



- When the vehicle ahead leaves the lane you are on.
- The vehicle ahead obstructs the view of the camera or blocks the lane line.
- There are large vehicles such as trucks and buses on the side or ahead.

### warning

LCC cannot fully identify and respond to the following environments and targets. Please pay attention to the environment and road conditions. In case of the following scenarios, please actively take control of the vehicle in time to ensure safe driving, including but not limited to:

- Totally rely on this system.
- Use it when the lane line is not clear or the light conditions are poor.
- Use it in an environment with many pedestrians, cyclists or animals.
- Hands off the steering wheel.
- Look away from the road of travel.

- When there is a barrier, isolation belt or curb on one side of the road.
- Occasionally, LCC will assist the vehicle to turn when steering assistance is not required or you do not intend to turn due to unclear and irregular lane lines or other lines or objects similar to lane lines on the lane surface. In this case, you should take control of the vehicle.

The above warnings, cautions and limitations do not cover all conditions that may affect the normal operation of LCC.

## Intelligent Auto Lane Change (ALC)

### Introduction

When LCC is activated and the turn signal is turned on, ALC can assist the driver in changing lanes.



## i 提示

On expressways, the available speed of ALC is 65~150 km/h.(The specific available speed, please refer to local laws and regulations)

On urban roads, the available speed of ALC is 15~150 km/h.(The specific available speed, please refer to local laws and regulations)

## ! warning

ALC is only a driver assistance function and cannot cope with all traffic, weather and road conditions. As the driver of the vehicle, you are responsible for driving safety. Please hold the steering wheel at all times, observe the road conditions and take control in time in case of danger. Do not rely on this function to control the vehicle; otherwise, injury or even death may be caused.

## Operation

### Opening and closing

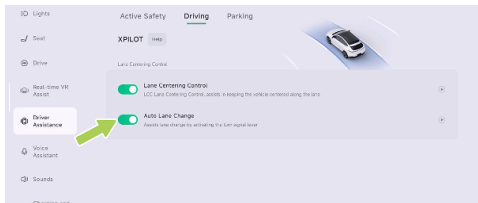

On the “ → **Driver Assistance** → **Driving**” interface of the central control panel, you can turn on/off Auto Lane Change.



### Use ALC



1. Check the lane change environment to confirm the safety of lane change.
2. Turn on the turn signal on corresponding side.
3. If the ALC lane change conditions are met, ALC will assist the driver in lane change. If the lane change conditions are not met, a prompt will be given on the instrument panel.

#### Tips

- ALC can only change one lane at a time. If you need to change the lane once more, please turn on the turn signal on the corresponding side again.
- ALC cannot change lanes across solid lines.
- When ALC judges that it is not suitable for lane change at present, the space box of target lane on the instrument cluster will be gray. When lane change is canceled, the instrument cluster will display **"Lane Change Canceled"** to prompt.
- After the lane change is completed or canceled by ALC, the turn signal will be automatically turned off.

#### Alarm and take control

#### warning

- If the vehicle sends a control request through the instrument panel, voice prompt and other means, you shall immediately take control of the vehicle.



- If any danger is found or there is a scenario that requires your control, take the control immediately, instead of waiting for the vehicle to send out a control request.

After ALC is activated, the lane change can be canceled by the following operations:

- Turn the steering wheel: cancel lane change and temporarily control the steering wheel. After conditions are met, LCC will be reactivated.
- Depress the brake pedal: cancel lane change and exit ACC and LCC.

### Warnings, Cautions and Limitations

ALC is a driver assistance function and cannot realize autonomous driving. When ALC is activated, the driver still needs to always observe the safety of lane change environment so as to take control of the vehicle in time when there is potential danger.

ALC is designed for driving comfort and convenience, and cannot cope with sudden

dangerous situations. The driver has the responsibility to stay vigilant at all times, ensure driving safety and control the vehicle. Do not rely on the system to deal with sudden emergencies. Always observe the road ahead and be prepared to take corrective action at any time, as failure to do so could result in serious injury or death.

The ALC may drop out unexpectedly at any time for unknown reasons. Be sure to observe the road safety situation and be ready to take appropriate measures. The driver is always responsible for safety in the lane change.

#### warning

Please read all the information about ALC in this manual to understand the limitations of this function. The driver should master these limitations before using this function.

- ALC cannot cope with all traffic, weather and road conditions. Do not use it in bad weather (such as rain, snow and fog) or on roads where pedestrians or cyclists may be present.



- Do not use ALC when there are vehicles in front of the subject vehicle or in adjacent lanes, as it may cause collision with other vehicles.
  - During the use of ALC, if another vehicle changes its lane into a lane that your vehicle is changing into at the same time, the function cannot avoid the collision risk at this moment. The driver should always observe the safety of lane change and timely intervene in vehicle control to avoid collision. The driver is fully responsible for the safety of lane change.
  - Do not use ALC when the vehicle is in poor conditions, such as abnormal four-wheel alignment and abnormal tire pressure.
  - Do not use ALC at the ramp, confluence and diversion of expressways or other roads.
  - Please use ALC with caution in turning sections, because the system may not be able to support lane change assistance.
  - Do not use ALC on urban roads or under changeable road conditions.
- Do not use ALC on winding roads with sharp bends, bumpy, icy or slippery roads. The system cannot stably provide lane change assist under these poor road conditions.
  - Occasionally, ALC will recognize the lane change conditions as lane change not allowed. In this case, you need to manually change lanes.
  - On road sections with heavy traffic, ALC may not be able to accurately detect the lane change environment. Please use ALC carefully.
  - Do not use ALC in sections with solid lane markings or other lane change restrictions.
  - When ALC is used, if other vehicles approach this vehicle quickly, the driver must take control immediately. ALC cannot avoid possible collisions.
  - Do not use ALC when there are other vehicles in the side rear blind spot of this vehicle or on the lane change route.



- The road has sharp curves or poor road conditions such as bumpy, slippery or icy surfaces.
- On a sloped road.
- Roads where pedestrians or cyclists may be present.
- Darkness (poor lighting) or poor visibility (caused by heavy rain, snow, fog, etc.).
- When strong light (such as oncoming headlight light or direct sunlight) obstructs the camera view.
- The vehicle ahead obstructs the view of the camera.
- The windshield blocks the view of the camera (water mist, dust or stickers).
- The lane lines are excessively worn, shielded or covered; the new and old road markings overlap; the road markings are temporarily adjusted or change rapidly (such as lane diverging, crossing or merging) due to road construction.

- Objects or landscape features projected onto the driveway creating large areas of shadow.
- Warning cones, warning signs or other objects are placed on the road surface.
- Radar is limited.
- The radar or camera is blocked (dust, cover, etc.), or the weather conditions are poor (such as heavy rain, snow and fog).
- When there is strong transverse airflow or gale on one side of the vehicle, ALC performance will be affected, and thus this function is not suitable for use in such weather.

The above warnings, cautions and limitations do not cover all conditions that may affect the normal operation of ALC.



## Speed Limit Assist (SAS)

### Introduction



SAS can set the maximum cruise speed synchronously with the road speed limit identified by TSR.

### warning

SAS is only a driver assistance function and cannot cope with all traffic, weather and road conditions. As the driver of the vehicle, you are responsible for driving safety. Do not rely on this function to control the vehicle; otherwise, injury or death may be caused.

### Operation

#### Opening and closing

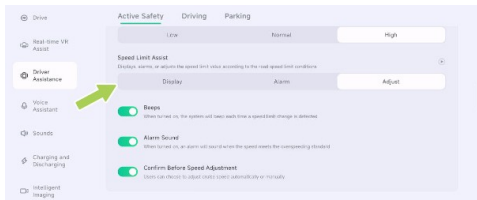

Speed Limit Assist can be set on the “ → **Driver Assistance** → **Active Safety**” interface of the central control panel.



1. If Adjust in Speed Limit Assist is selected, the Driver Confirmation is turned on and ACC/LCC is activated, the speed limit can only be implemented after the driver confirms each change in speed limit.
2. If Adjust in Speed Limit Assist is selected, the Driver Confirmation is turned off and ACC/LCC is activated, the speed limit can be implemented without driver confirmation in each change of speed limit.

The above warnings, cautions and limitations do not cover all conditions that may affect the normal operation of SAS.

### Warnings, Cautions and Limitations

SAS may not fully function or may provide inaccurate information in the following cases:

- Camera limitations [See 122 page](#).
- Recent changes to roads or speed limits such as construction, controls etc.
- Traffic signs are in poor condition: damaged, faded, blurred or not placed and set as required.



### Forward/backward radar warning

#### Introduction

When the vehicle is parked or running at a low speed, the ultrasonic radar can detect the distance between the vehicle and the surrounding obstacles and give a warning through the instrument panel, central control panel and alarm sound.

#### **caution**

- When a red bar is displayed, it means that the obstacle is very close to your vehicle and special attention should be paid.
- The frequency of the alert sound will gradually increase as the distance between the vehicle and the obstacle decreases.

#### **Tips**

- When the vehicle is in D gear and the speed is less than 12 km/h, the radar will give early warning; when the vehicle is in R gear, there is no speed limit for radar warning.

- Even if the obstacle is soft (such as tall and thin weeds) and will not damage the vehicle, the radar warning will still issue an early warning.

#### Warnings, Cautions and Limitations

#### **warning**

The radar warning may not work normally in the following scenarios:

- Camera limited [See 122 page](#).
- The vehicle approaches the obstacle at a high speed.

The above warnings, cautions and limitations do not cover all situations that affect the normal operation of radar warning.



## Intelligent Parking Assist

### Introduction

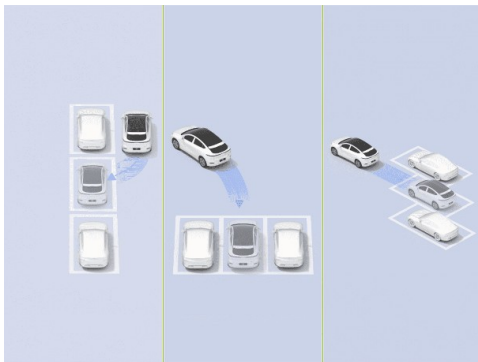

APA can assist the driver in parking in and out of vertical, parallel and diagonal parking spaces with wired or wireless frames. It supports the following activation methods:

- Central control panel

- Mobile phone key

#### warning

APA is only a driver assistance function and cannot cope with all traffic, weather and road conditions. As the driver of the vehicle, you are responsible for driving safety. Please hold the steering wheel at all times, observe the road conditions and take control in time in case of danger. Do not rely on this function to control the vehicle; otherwise, injury or even death may be caused.

#### Instrument panel indicator



APA unavailable



APA can be activated



APA activated



## Operation

### Opening and closing

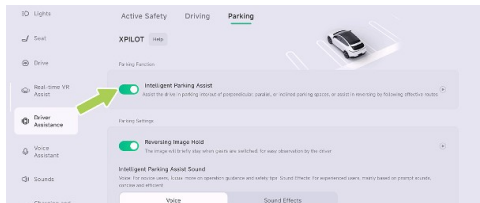

The Intelligent Parking Assist can be turned on/off on the “ → **Driver Assistance** → **Parking**” interface of the central control panel.

### Use APA

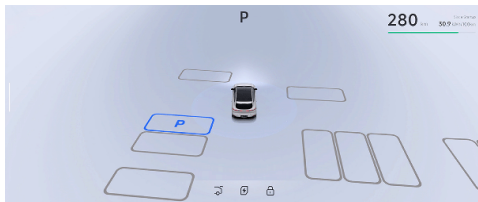

1. The “**Real-time VR Assist**” interface will enter the parking mode with any of the following methods:

- Automatic switching. When the vehicle enters a parking environment such as underground garage, “**Real-time VR Assist**” will automatically enter the parking mode.
- Press the steering wheel shortcut key [See 186 page](#).
- Tap “**Park**” on the central control panel.
- When the SR interface displays the parking space icon, stop and switch to R gear.

2. Drive to find the target parking space.



## i Tips

- In the process of searching for a parking space, please keep the lateral distance between your vehicle and the parking space within 1~2m.
- In the process of searching for parking space, the vehicle speed shall not exceed 24 km/h.



3. When the target parking space is highlighted, depress the brake pedal and tap on the central control panel to select the target parking space.
4. At this time, you can park in the parking space by the following methods:

- Center control panel: Tap "**Start Autopark**" on the central control panel, and then release the brake pedal.
- Mobile phone key: Shift to P gear, get off the vehicle and close the doors. Open the intelligent parking module of mobile App, tap "**Remote parking**", and tap and hold the parking button after the exterior rearview mirrors are folded and the hazard warning lights are turned on.

## i Tips

- After parking in the parking space with a mobile phone key, the vehicle will be automatically switched to P gear, locked and powered off.
- When parking in the parking space with a mobile phone key, keep the mobile phone near the vehicle; otherwise, the function will exit.
- When the vehicle is parked into a parking space with a mobile phone key, it is allowed to open the door/trunk for



picking up objects within five minutes after remote parking is paused. After picking up objects, you can tap Continue to complete remote parking.

### Alarm and take control

#### warning

- If the vehicle sends a control request through SR interface, voice broadcast or other means, you shall take the control immediately.
- If any danger is found or there is a scenario that requires your control, take the control immediately, instead of waiting for the vehicle to send out a control request.
- Please make sure that there is no one in the vehicle before parking in the parking space through mobile APP.

When APA is activated, it can be paused in the following ways:

- Parking with central control panel: Depress the brake pedal at any time to suspend APA.
- Parking with mobile phone key: Release the parking button on the mobile App page.

When safety is confirmed, the APA can be restored by:

- Parking on central control panel: Tap “**Continue**” on the central control panel.
- Parking with mobile phone key: tap and hold the parking button on the mobile App.

The APA will exit if:

- Turn the steering wheel manually.
- Depress the brake pedal to shift gears.
- APA pauses and does not recover after 30 seconds.
- The door is opened, the accelerator pedal is depressed and the brake pedal is depressed, causing APA to pause for 3 times.



## Warnings, Cautions and Limitations

### warning

Do not use APA in the following scenarios:

- The road is a ramp.
- One or more ultrasonic sensors and panoramic cameras are stained or obstructed (such as mud, ice, snow or water).
- Unfavorable climatic conditions (such as heavy rain, snow and fog).
- The road surface is uneven, icy or slippery.
- The curb is not made of stone or cannot be detected.
- Road surface with height difference (such as cliff edge, high platform and sidewalk facing the street).
- A tire chain or spare wheel is installed.
- The loaded object protrudes from the vehicle.

- Any of the left and right exterior rearview mirrors is damaged or in an abnormal position.
- Parking spaces on narrow streets, or narrow parking spaces.
- Normal operation of the vehicle functions will be affected if the vehicle is refitted or repaired at a service center other than XPENG Service Center.

### warning

In the following scenarios, APA may not be able to take safety measures and you shall immediately take control of the vehicle:

- When the instrument panel or central control panel sends a control request to you.
- When APA exits unexpectedly.
- Encountering vehicles, pedestrians and objects during parking without timely completion of automatic avoidance or braking.



### warning

The following situations may occur in APA, please get ready to take control of the vehicle:

- Obstacles at or above the height of the exterior rearview mirror.
- Suspended obstacles with small size and width.
- Targets in the blind spot of camera or radar.
- Pedestrians or animals.

The above warnings, cautions and limitations do not cover all conditions that may affect the normal operation of APA.

## Intelligent Parking-out Assist (AEP)

### Introduction



The following methods can be used to park the vehicle out of a parking space if it has not been moved after APA [See 86 page](#) is used:



Central control panel: Get on the vehicle, close the door, switch to R gear, and tap **“Start Exiting the Parking Space”** on the central control panel.

- Mobile phone key: Open the mobile App, tap **“Remote parking”**, and tap and hold the parking-out button after the exterior rearview mirrors are folded and the hazard warning lights are turned on.

## **i** Tips

The parking-out function can only be used after the owner's account is logged in on the central control panel and the APA function switch is turned on.

## **! warning**

- AEP is only a driver assistance function and cannot cope with all traffic, weather and road conditions. As the driver of the vehicle, you are responsible for driving safety. Please hold the steering wheel at all times, observe the road conditions and take control in time in case of danger. Do not rely on this function to control the vehicle; otherwise, injury or even death may be caused.
- The warning precautions, alarm and control of APA [See 90 page](#) are also applicable to AEP.



## Straight Line Summons

### Introduction

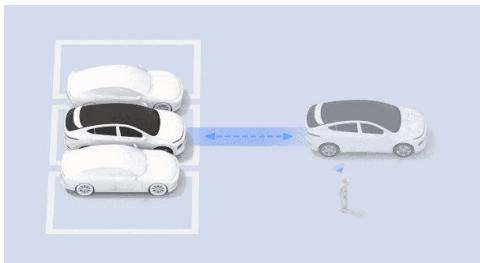

The mobile App can be used to control the vehicle to move forward or backward, for vehicles to enter and exit narrow parking spaces where people cannot get on and off smoothly.

#### **i** Tips

Straight Line Summons has the function of obstacle avoidance. If an obstacle is encountered, it will automatically pause.

### **!** warning

Straight Line Summons is only a driver assistance function and cannot cope with all traffic, weather and road conditions. As the driver of the vehicle, you are responsible for driving safety. Do not rely on this function to control the vehicle; otherwise, injury or even death may be caused.

### Operation

#### Opening and closing

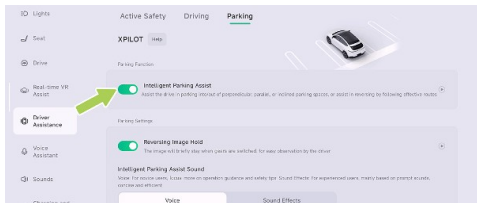

The Intelligent Parking Assist can be turned on/off on the “**☺** → **Driver Assistance** → **Parking**” interface of the central control panel.



## Straight Line Summons of mobile phone key

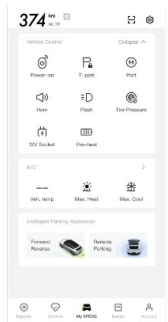

1. Open the mobile App, tap **“Forward Reverse”** to fold the exterior rearview mirrors and turn on the hazard warning lights.
2. Tap and hold the switch to control the vehicle to move forward or backward. Release the switch to stop the vehicle.
3. After the vehicle enters or leaves the parking space, tap Back to exit the function.

## Alarm and take control

### warning

If any danger is found or there is a scenario that requires your control, suspend the function immediately, instead of waiting for the obstacle avoidance function to be triggered.

Straight Line Summons will exit in the following cases:

- The mobile phone key is too far away from the vehicle.
- The Bluetooth between the mobile phone and vehicle is disconnected.
- Obstacle avoidance is triggered 3 times during a single use.
- The vehicle is not controlled to move forward or backward for more than 30s.



### Warnings, Cautions and Limitations

#### warning

Do not use the Straight Line Summons in the following scenarios:

- One or more ultrasonic sensors and panoramic cameras are stained or obstructed (such as mud, ice, snow or water).
- Unfavorable climatic conditions (such as heavy rain, snow and fog).
- The road surface is uneven, icy or slippery.
- The road is a ramp.

#### warning

In the following scenarios, safety measures may not be taken for Straight Line Summons, and you shall immediately take control of the vehicle:

- The system prompts you to take control of the vehicle.

- Encountering vehicles, pedestrians and objects during parking, without active avoidance or braking completed in time.
- Straight Line Summons summons unexpected exit.

#### warning

Do not have the following behaviors when using Straight Line Summons:

- Look away from the vehicle.
- Completely rely on Straight Line Summons for parking.

The above warnings, cautions and limitations do not cover all conditions that affect the normal operation of the Straight Line Summons.

## Reversing Assist

### Introduction

Reversing Assist is a function that assists the driver to reverse along the original route. After

# Parking assist



entering difficult road conditions such as dead ends and narrow roads, you can use Reversing Assist to get out of trouble.

## Tips

Reversing Assist has the function of obstacle avoidance. If there is an obstacle, it will automatically pause.

## warning

Reversing Assist is only a driver assistance function and cannot cope with all traffic, weather and road conditions. As the driver of the vehicle, you are responsible for driving safety. Do not rely on this function to control the vehicle; otherwise, accidents may be caused.

## Operation

### Opening and closing

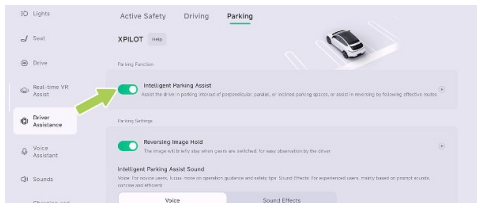

The Intelligent Parking Assist can be turned on/off on the “ → **Driver Assistance** → **Parking**” interface of the central control panel.

### Use Reversing Assist

1. When driving forward at a speed lower than 20 km/h, the system will automatically remember the latest available path.
2. Stop the vehicle and shift to R gear.



3. Tap the “**Reversing Assist**” button on the central control panel to start “**Reversing Assist**”.
4. The system will automatically reverse at a low speed according to the effective path.

### **caution**

- The forward path in D gear below 20 km/h may be recorded as an available path, and the path can be up to 100 meters long.
- Before Reversing Assist is activated, the available route will be cleared in case of reversing, the steering wheel being turned to an excessive angle or ramp driving.

## Warnings, Cautions and Limitations

### **warning**

Do not use Reversing Assist in the following scenarios:

- The road is a ramp.
- One or more ultrasonic sensors and panoramic cameras are stained or

obstructed (such as mud, ice, snow or water).

- Unfavorable climatic conditions (such as heavy rain, snow and fog).
- The road surface is uneven, icy or slippery.
- Road surface with height difference (such as cliff edge, high platform and sidewalk facing the street).

### **warning**

In the following scenarios, safety measures may not be taken for Reversing Assist, and you shall immediately take control of the vehicle:

- The system prompts you to take control of the vehicle.
- When Reversing Assist exits unexpectedly.
- Encountering vehicles, pedestrians and objects during reversing without timely completion of automatic avoidance or braking.



**⚠ warning**

The following situations may be encountered when using Reversing Assist. Please get ready to take control of the vehicle:

- Obstacles at or above the height of the exterior rearview mirror.
- Suspended obstacles with small size and width.
- Targets in the blind spot of camera or radar.
- Pedestrians or animals approaching suddenly.

**⚠ warning**

When using Reversing Assist, do not fully rely on it.

The above warnings, cautions and limitations do not cover all conditions that affect the normal operation of the Reversing Assist.



### Forward Collision Warning (FCW&AEB)

#### Introduction

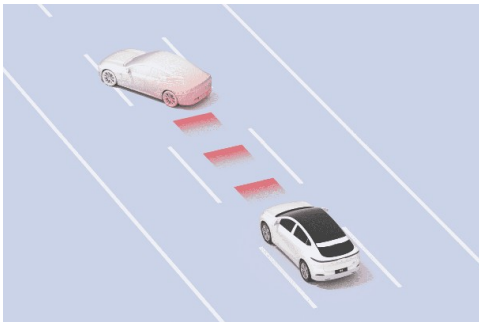

The forward collision warning includes forward collision warning (FCW) and automatic emergency braking (AEB), which can reduce the risk of vehicle collision or reduce the speed before vehicle collision, thus improving driving safety.

#### warning

The FCW does not work when the vehicle is in R gear.

When the function detects a collision risk, it will first give a warning through the instrument panel, prompt sound and seat belt prompt.

#### warning

- For pedestrians and bicycles, the forward collision warning (FCW) only works when the vehicle speed is between 10 km/h and 85 km/h;
- For motor vehicles, the forward collision warning (FCW) only works when the vehicle speed is between 10 km/h and 150 km/h.
- When the vehicle gives an early warning, the driver shall immediately take emergency measures such as avoidance. Do not fully rely on AEB to avoid or mitigate collision.

If the risk further increases, and the driver still does not brake or the braking force is too small,



the vehicle will brake actively to reduce collision and injury.

## warning

- For pedestrians and bicycles, automatic emergency braking (AEB) only works when the vehicle speed is between 4 km/h and 85 km/h;
- For motor vehicles, automatic emergency braking (AEB) only works when the vehicle speed is between 4 km/h and 150 km/h.
- If AEB stops the vehicle, the vehicle will remain stationary for a short time, and the driver should brake as soon as possible.
- In the process of AEB intervention in vehicle braking, depressing the accelerator pedal may cause brake interruption.

## warning

- FCW is an assist function, which cannot work in all driving, traffic, weather and road conditions and cannot replace focused driving and accurate judgment. Thus, the

driver bears full responsibility for driving safety. Always observe the road conditions during driving, and do not rely on FCW to warn or avoid a possible collision. Many factors can reduce or affect performance, leading to unnecessary, ineffective or inaccurate warnings, brake interventions or omissions. Relying on FCW for warning or avoiding a potential collision may result in serious personal injury or death.

- Automatic emergency braking is not designed to prevent collisions. At best, it can only minimize the impact of a frontal collision by trying to reduce driving speed. Relying on AEB to avoid collision may cause serious personal injury or death.

## Instrument panel indicator



FCW OFF



Fault in FCW



## Operation

### Opening and closing

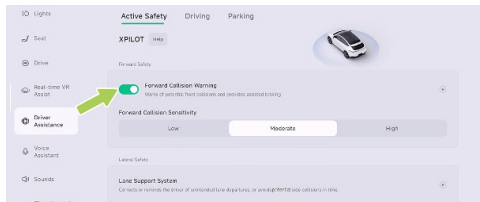

The Forward Collision Warning can be turned on/off in the “**Driver Assistance**→**Active Safety**” interface of the central control panel.

#### **i** Tips

The FCW will be turned on automatically every time the vehicle is driven. For your safety, it is recommended to keep it always on.

## Warnings, Cautions and Limitations

Before using FCW, the driver should refer to this chapter for guidance and restrictions on use of relevant functions.

### **! warning**

In the following scenarios, FCW may not be triggered, may be triggered by mistake or may be triggered late:

- Radar or camera limited [See 122 page](#).
- In darkness or poor visibility. For example, poor lighting conditions, heavy rain, heavy snow and dense fog.
- When strong light obstructs the camera field of view. For example, oncoming headlight light or direct sunlight.
- The windshield blocks the view of the camera (water mist, dust or stickers).
- There is a vehicle running in the wrong direction ahead.



- The vehicle is running on a road with large curves or roads in poor conditions.
- The target suddenly appeared. For example, other vehicles suddenly move quickly or close to the front of this vehicle.
- The target overlap rate (overlap between front end width of your vehicle and rear end width of the vehicle ahead) is insufficient.
- The driver brakes, depresses the accelerator pedal deeply, and turns the steering wheel quickly or greatly.
- There are stationary vehicles at the entrance and exit of curves.
- The vehicle is running in a curve and the adjacent vehicle suddenly decelerates.
- There is a vehicle overtaking in front at the curve.
- The vehicle is passing a stationary roadside target or overtaking during lane change.
- The vehicle ahead changes the lane after braking.

- The vehicle passes by a speed bump, floor drain or iron gate in the garage.
- The vehicle passes under a flyover, pedestrian overpass or destination sign.
- The vehicle passes through flyover joints, metal guardrails on the roadside and other scenarios.
- There are traffic lights, water columns of sprinklers, splashing water spots, iron pillars on the road surface, air steel pipes, floating plastic bags, zip-top cans rolling on the road surface, underground parking garages, highway toll stations, manhole covers, etc.

The above warnings, cautions and limitations do not cover all conditions that may affect the normal operation of FCW&AEB.



### Blind Spot Detection & Lane Change Assist (BSD&LCA)

#### Introduction

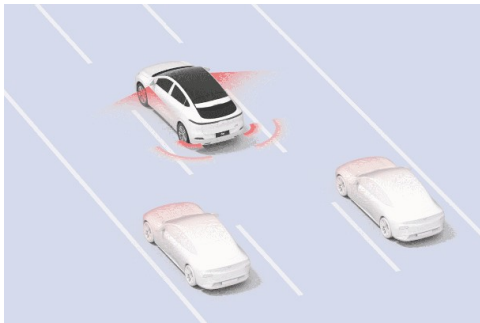

Blind spot safety assist includes blind spot detection warning (BSD) and lane change alert (LCA), which can monitor the lanes on both sides of the vehicle and give a warning when there is a risk in lane change.



When the vehicle is in D gear and the vehicle speed is greater than 10 km/h, if there is a vehicle in the blind spot or a quickly approaching vehicle behind the blind spot, the warning light on the corresponding exterior rearview mirror will be normally on. At this time, if the turn signals on corresponding side are turned on, the warning light on the exterior rearview mirror will flash to give a warning.



## warning

Blind spot safety assist is only a driver assistance function and cannot cope with all traffic, weather and road conditions. It cannot replace the driver's focused driving and accurate judgment, nor can it replace the use of interior and exterior rearview mirrors. As the driver of the vehicle, you are responsible for driving safety and it is always your responsibility to change lanes in a safe manner. Do not rely on this function to control the vehicle; otherwise, injury or death may be caused.

## Operation

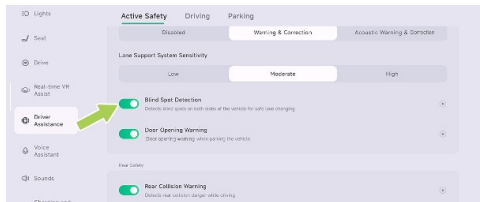

The Blind Spot Detection can be turned on/off in the “→**Driver Assistance**→**Active Safety**” interface of the central control panel.

## Warnings, Cautions and Limitations

### warning

The BSD&LCA may not work normally in the following scenarios:

- Camera limited [See 122 page](#).
- Sharp curves.
- Reversing.
- There is a moving metal object with large volume in the blind area.

The above warnings, cautions and limitations do not cover all conditions that may affect the normal operation of BSD&LCA.



### Door Opening Warning (DOW)

#### Introduction



When there is a risk of collision when the door is opened, DOW can remind the driver and passengers.

When the vehicle speed is 0~5 km/h, there are vehicles, pedestrians and bicycles approaching at a certain speed within the detection range and there is a risk of collision when the door is

opened, DOW will give a warning in the following ways:

- Instrument panel.
- Central control panel.
- Warning sound.



- The warning light of the corresponding exterior rearview mirror is normally on.



## warning

DOW is only a driver assistance function, which aims to remind the driver and passengers to pay attention to the door surrounding when opening the door. It cannot replace the visual observation of the driver and passengers and the function of interior and exterior rearview mirrors. It cannot cope with all traffic, weather and road conditions. As the driver of the vehicle, you are responsible for driving safety. Do not rely on this function to control the vehicle; otherwise, injury or death may be caused.

## Operation

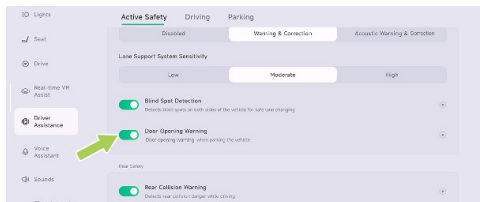

The Door Opening Warning can be turned on/off in the “→**Driver Assistance**→**Active Safety**” interface of the central control panel.

## Warnings, Cautions and Limitations

### warning

The DOW may not work properly in the following scenarios:

- Camera limited [See 122 page](#).
- Smaller targets or stationary targets.
- The target speed is too fast or there is steering behavior. For example, the target vehicle changes lane to the rear of your vehicle, and other vehicles suddenly change lanes behind your vehicle in the detection area.
- Other vehicles or cyclists behind your vehicle.
- The vehicle stops at a turning or beside a wall.



The above warnings, cautions and limitations do not cover all conditions that may affect the normal operation of DOW.

### Rear Collision Warning (RCW)

#### Introduction

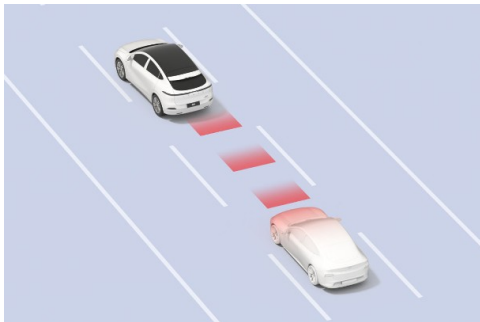

During driving, RCW can detect and warn the collision risk behind the vehicle.

When the vehicle speed is 15-160 km/h, there are vehicles, pedestrians and bicycles approaching at a certain speed within the detection range and there is a risk of collision, RCW will give a warning through the instrument panel and prompt sound, and remind you of the vehicles behind by turning on the hazard warning light.

#### **⚠ warning**

RCW is only a driver assistance function and cannot cope with all traffic, weather and road conditions. It cannot replace the driver's focused driving and accurate judgment, nor can it replace the use of interior and exterior rearview mirrors. As the driver of the vehicle, you are responsible for driving safety. Do not rely on this function to control the vehicle; otherwise, injury or death may be caused.



## Operation

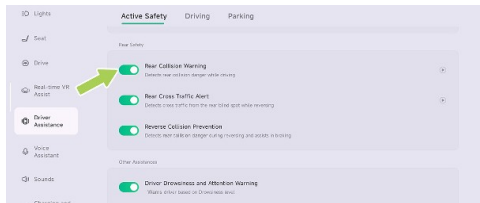

The Rear Collision Warning can be turned on/off in the “ **Driver Assistance** **Active Safety**” interface of the central control panel.

## Warnings, Cautions and Limitations

### warning

The RCW may not work properly in the following scenarios:

- Camera limited [See 122 page](#).
- The speed of the detected object is too high.

- There is a moving metal object with large volume in the blind area.
- Sharp curves.

The above warnings, cautions and limitations do not cover all conditions that may affect the normal operation of RCW.

## Rear Cross Traffic Alert (RCTA)

### Introduction

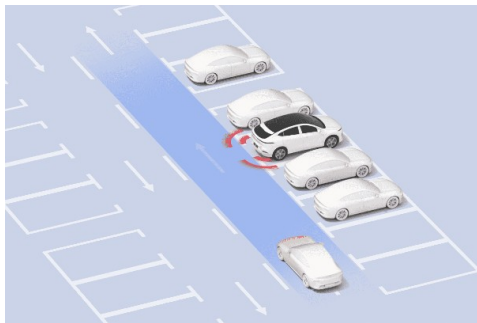



When the reversing vision is limited, RCTA can remind the driver of the approaching vehicles in the blind spots on both sides behind.

When the vehicle is in R or N gear and the backward speed is 2~15 km/h, there are vehicles, pedestrians and bicycles approaching at a certain speed within the detection range and there is a risk of collision, RCTA will be activated to give a warning through the instrument panel and warning sound.

## warning

RCTA is only a driver assistance function and cannot cope with all traffic, weather and road conditions. It cannot replace the driver's focused driving and accurate judgment, nor can it replace the use of interior and exterior rearview mirrors. Do not take a risk of driving because the system improves comfort. It is always the driver's responsibility to reverse in a safe manner. Please do not rely on this function to control the vehicle; otherwise, injury or death may be caused.

## Operation

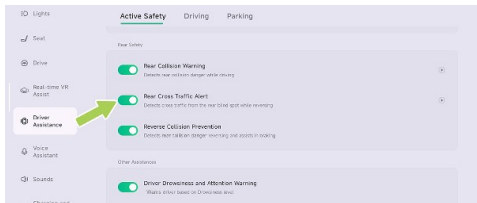

The Rear Cross Traffic Alert can be turned on/off in the “ **Driver Assistance** **Active Safety**” interface of the central control panel.

## Warnings, Cautions and Limitations

### warning

Do not use RCTA in the following scenarios:

- Restricted field of vision.
- Complex traffic conditions, such as roads with large traffic flow and crossing multiple carriageways.



### warning

The RCTA may not work properly in the following scenarios:

- Camera limited [See 122 page](#).
- The speed of the detected object is too high.
- There is a moving metal object with large volume in the blind area.

### warning

The following situations may occur in RCTA:

- Pedestrians and bicycles are not accurately identified.

The above warnings, cautions and limitations do not cover all conditions that may affect the normal operation of RCTA.

## Reverse Collision Prevention

### Function Introduction

The RCP function detects the danger of collision behind the vehicle when reversing and perform warning and assistant braking.

### warning

- The smart technology of RCP cannot exceed the physical limit, and can only work within the limit of the system. Do not take risks due to the advanced system. The system is not a substitute for driver's attention.
- RCP is a driving assist feature and does not work in all situations.
- The RCP in no way means that the driver can do nothing and be careless in driving. It is always the driver's responsibility to reverse in a safe manner.
- Do not use the system when the vision is restricted and it is difficult to see traffic



conditions (e.g. on roads with heavy traffic or crossing multiple traffic lanes).

- The system may not be able to accurately identify cyclists and pedestrians, so you must always pay attention to the surroundings.

## Function Activated

When the vehicle is in R/N gear, the vehicle speed is 1~12 km/h, and there are vehicles, pedestrians, and two-wheeled vehicles approaching at a certain speed within the detection range, and there is a risk of collision, the RCP will be activated and an alert will be sent via ICM or warning sound.

If the driver fails to brake in time or the braking force is too small, the RCP will be activated to reduce or avoid injuries in a vehicle collision.

### **caution**

If the RCP stops the vehicle, the vehicle will remain stationary for a while and the driver should take over braking as soon as possible.

## Operation

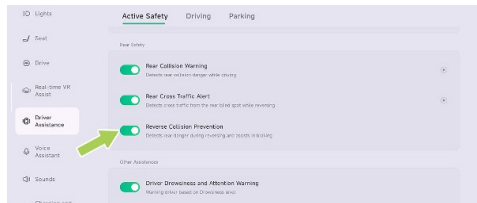

The Reverse Collision Prevention can be turned on/off in the “→**Driver Assistance**→**Active Safety**” interface of the central control panel.

## Warnings, Cautions and Limitations

RCP does not always work in all situations, and unnecessary, untimely or ineffective warnings or missed warnings can occur for a variety of reasons, such as:

- Radars are restricted [See 122 page](#).
- The presence of bulky, moving metal objects at the blind spot.

# Active safety



- The object to be detected is moving too fast.

The above examples, warnings, and restrictions do not cover all the conditions that may affect the proper operation of RCP.

## Lane support systems (LSS)

### Introduction

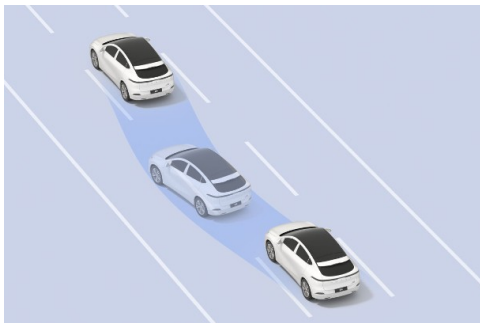

LSS includes Lane Departure Assistance (LDA) and Lane Keeping Assist (ELK). The former

includes lane departure warning (LDW) and lane keeping assist (LKA), which can alert and correct unintentional lane departure or avoid possible lateral collision in an emergency.

#### warning

LSS is only a driver assistance function and cannot cope with all traffic, weather and road conditions. It cannot replace the driver's dedicated driving and accurate judgment. As the driver of the vehicle, you are responsible for driving safety. Do not rely on this function to control the vehicle; otherwise, injury or death may be caused.

If the early warning mode is selected, only LDW will be turned on; if the correction mode is selected, all LDW, LKA and ELK will be turned on:

- LDW: When the vehicle speed is 60~150 km/h and the vehicle deviates from the lane without the corresponding turn signals on, the function will give a warning through the instrument panel, central control panel, prompt sound



and steering wheel vibration until the driver corrects the vehicle position.

## warning

LDW only has a reminding function and cannot make the vehicle back to the lane. Please correct the vehicle position in time when LDW gives an alarm.

- LKA: When the vehicle speed is 60~150 km/h and the vehicle deviates from the lane without the corresponding turn signals on, LKA will give a warning through the instrument panel, central control panel and prompt sound, and intervene in steering wheel control to correct the vehicle back into the lane.
- ELK: When the vehicle speed is 60~150 km/h and the vehicle is about to collide with the curb, oncoming vehicles or overtaking vehicles, ELK will give a warning through the instrument panel, central control panel and prompt sound, and intervene in steering wheel control for emergency avoidance.

## caution

- When the turn signal is on or the driver has obvious steering intention (such as turning the steering wheel quickly, braking, depressing the accelerator pedal deeply to accelerate, and turning on the hazard warning light), the LSS function will not give an alarm or interfere with lane departure.
- The activation of this function will be suppressed by the wipers and hazard warning light.

## Operation

### Set LSS

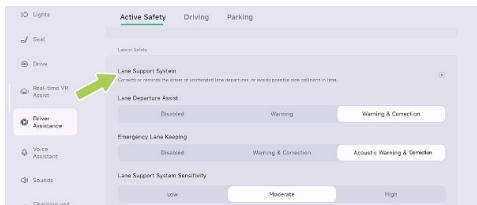



On the “☰ → **Driver Assistance** → **Active Safety**” interface of the central control panel, you can set the assistance mode and triggering conditions of the Lane Support System (LSS).

If Lane Departure Assist is set to Warning, only LDW will be turned on; if it is set to Warning & Correct, LKA will be turned on.

### Tips

If the LSS function is turned off, it will be turned on again after power-on.

## Warnings, Cautions and Limitations

### warning

The LSS may not work properly in the following scenarios:

Special road conditions or complex sections:

- The lane lines are excessively worn; the new and old road markings overlap; the road markings are temporarily adjusted or change

rapidly (such as lane diverging, crossing or merging) due to road construction.

Poor weather or light conditions:

- When there is a large transverse airflow or strong wind on one side of the vehicle.
- Darkness (poor lighting) or poor visibility (caused by heavy rain, snow, fog, etc.).
- When strong light (such as oncoming headlight light or direct sunlight) obstructs the camera view.
- Objects or landscape features are casting strong shadows on lane markers.
- The lane line cannot be identified or is incorrectly identified due to light reasons, such as reflection of the lane line caused by strong illumination, poor visibility or insufficient lighting caused by bad weather and night.

Camera limited:

- Camera limitations [See 122 page](#).
- The camera is blocked (dust, cover, etc.).



- There is a vehicle ahead that may block the camera field of view.

### warning

The following situations may occur in the LSS:

- Give early warning or apply braking when there is no risk of collision.

The above warnings, cautions and limitations do not cover all conditions that may affect the normal operation of LSS.

## Traffic Sign Recognition (TSR)

### Introduction

TSR can identify speed limit signs on the road and obtain speed limit information based on navigation, which is displayed on the displayed on the SR interface. TSR will also give a warning when the vehicle overspeeds.

### Speed limit reminder

TSR can identify the speed limit from road signs and intelligent traffic violation monitoring systems, and give a reminder of different icons:



Speed limit on the speed limit sign

### Tips

TSR can recognize the speed limit sign, variable speed limit sign, end of speed limit sign, area speed limit sign, multi-lane speed limit sign, multiple speed limit sign, highway ramp speed limit sign.

### Overspeed alarm

When TSR identifies a road speed limit:

- Manual driving with ACC/LCC assistance: When the road speed limit is greater than 20km/h and overspeed occurs, the speed limit icon on the instrument panel will flash



continuously, and an audible warning will be triggered.

## warning

TSR is only a driver assistance function and cannot cope with all traffic, weather and road conditions. As the driver of the vehicle, you are responsible for driving safety. Do not rely on this function to control the vehicle; otherwise, injury or even death may be caused.

## Operation

### Opening and closing

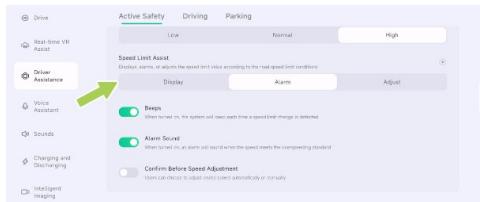

Speed Limit Assist can be set on the “→**Driver Assistance**→**Active Safety**” interface of the central control panel.

1. If Display of Speed Limit Assist is selected, only the icon flashes as an alarm.
2. Speed Limit Assist: Select Alarm and turn on Beeps. There will be a prompt sound for each speed limit change.
3. Select Alarm in Speed Limit Assist and turn on Alarm Sound. There will be a prompt sound for each overspeed.

## Warnings, Cautions and Limitations

### warning

The TSR may not work properly in the following scenarios:

- Radar or camera limited [See 122 page](#).
- Recent changes to roads or speed limits such as construction, controls etc.



- Traffic signs are in poor condition: damaged, faded, blurred or not placed and set as required.
- Sensor limitation such as camera blockage will lead to inaccurate recognition and even trigger the fault indicator. If the fault indicator is still on after the vehicle is powered off, please follow the after-sales guidance.

The above warnings, cautions and limitations do not cover all conditions that may affect the normal operation of TSR.

### Intelligent High Beam (IHB)

#### Introduction

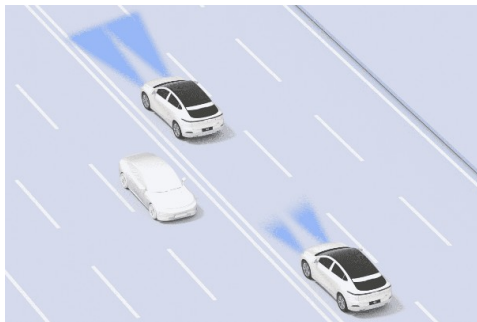

IHB can automatically switch between high and low beams according to the conditions of vehicles ahead and ambient lighting, so as to avoid effecting surrounding traffic participants.



## Instrument panel indicator



IHB is on and the high beam is not on.



IHB is on and the high beam is on.



IHB is faulty.

## Operation

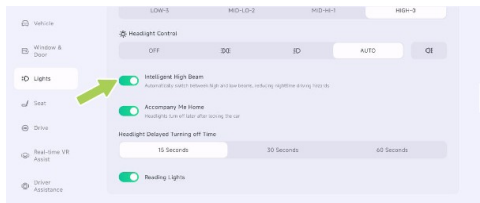

The Intelligent High Beam can be turned on/off on the “☰ → **Lights** → **Headlights**” interface of the central control panel.

### Use IHB

When the following conditions are met at the same time, IHB is activated and the vehicle automatically switches between high beam and low beam according to the road environment:

- The light switch of the central control panel is in automatic.
- The working speed range is 30~150 km/h.

### Tips

If the vehicle speed is less than 15 km/h or more than 150 km/h, IHB will exit.

## Warnings, Cautions and Limitations

### warning

IHB may not work properly in the following scenarios:



- Camera limitations [See 122 page.](#)

The above warnings, cautions and limitations do not cover all conditions that may affect the normal operation of IHB.

### Driver Status Monitor (DSM)

#### Introduction



The DSM (Driver Status Monitor) system starts working after the vehicle is powered on, and when the driver experiences fatigue or distraction at a the vehicle speed exceeds 20km/h, the system will issue a reminder.

When the driver is fatigued or distracted, the system will remind the driver through instrument panel text and sound. When the driver is under drowsiness or distraction condition for a long time, the system will advance the timing of lane departure warning and forward collision warning to give the driver enough reaction time.



## Operation

### Opening and closing Driver Drowsiness Warning (DDW)

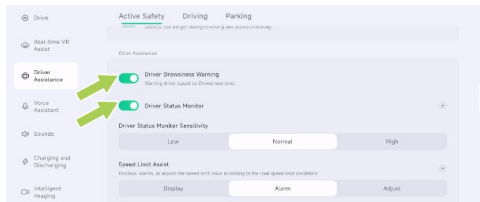

On the “ → **Driver Assistance** → **Active Safety**” interface of the central control panel, you can set to turn on or off DSM. As per regulatory requirements, DSM is turned on by default every time the vehicle is started. DSM provides high, medium and low sensitivity, which is defaulted at the time of delivery. Users can adjust it according to their driving preferences. The system will remember the user's sensitivity selection.

DDW is used to monitor the drive drowsiness. When the driver is under drowsiness condition, the system will give an alarm to remind the driver to concentrate or take other actions to relieve drowsiness and avoid drowsiness driving.

As required by the Ministry of Transport, the DDW alarm is turned on by default and can be turned off only after the alarm has been triggered. Each time the vehicle is powered off, it will be restored to the status that it cannot be turned off before the alarm is triggered.

#### **warning**

- After DSM/DDW is turned off, it will not be able to monitor and remind the driver of drowsiness or distraction, which affects driving safety. Please reconsider before turning it off.
- DSM/DDW is an assist function. Do not rely on it to cope with all scenarios. The driver must always control the vehicle and observe the road environment.



- Please always keep focusing on driving, and do not drive under drowsiness condition. When the system prompts "Please pay attention to road conditions", please adjust your driving behavior in time, or park and rest in a service area or safe place as soon as possible.

### **caution**

When DSM/DDW is working, the interior camera will not store or transmit audio and video data involving personal privacy.

### **warning**

DSM/DDW may not work normally in all scenarios, and various factors may cause functional failures, such as:

- The power supply voltage is relatively high or low;
- The hardware circuit is disconnected;
- Interior camera blocked or faulty.

The above warnings, cautions and limitations do not cover all conditions that affect the normal operation of DSM.



## Safe Use Of Assisted Driving System

### Limitations Of Radars And Cameras

#### Tips

Make sure that the radar and camera surfaces are clean without coverings before using the driving assist function [See 244 page](#).

#### warning

The radar/camera may fail to recognize the target, or recognize the target at delay or incorrectly when:

- The radar or camera is obscured or covered by foreign matters such as snow, ice, frost, rain, fog, standing water, dust, etc.;
- The radar, camera or related components are faulty;
- There are adverse weather conditions, such as rain, snow, fog, etc.;
- The vehicle is shaking or vibrating caused by uneven roads or other reasons;

- The vehicle is interfered by the nearby sound sources of the same frequency;
- There are objects in the vicinity of the vehicle that can cause false reflection of sound waves;
- The target detected by the radar is covered by substances that absorb sound waves, such as snowflakes, foam, cotton objects, etc.;
- The detected object is too small.
- In the following special circumstances, false alarms may be given for some metal guardrails, median strips, concrete walls, etc.
- Sudden change in the brightness of the surroundings, such as the entrance or exit of a tunnel;
- Large shadows cast by buildings, landscapes or large vehicles;
- Vehicle collisions where the radar or camera mounting position is changed;
- Bright light, such as oncoming headlights or direct sunlight;



- Dim surroundings, such as at night, dawn, dusk, tunnels, etc..

### **warning**

The following targets cannot be recognized by the radar/camera:

- Special vehicles, such as vehicles with a covered rear end, damaged vehicles, irregular shaped vehicles, etc.
- Animals, traffic lights, walls and other unknown obstacles in the middle of the road.
- Some metal guardrails, median strips, concrete walls, etc.
- Pavement testing equipment, traffic cones, safety barrels, tripods, small construction signs, etc.
- Static obstacles, such as road construction facilities in the middle of the road (traffic cones, safety barrels, traffic bollards, warning triangles, or other roadblocks).

- Static objects, such as low-speed or stationary sweepers, overturned vehicles, boulders, tripods, median strips, pedestrians crossing the road, etc.

## Safety Instructions

### Important Notice

If the vehicle has any of the following conditions, please contact the XPENG Service Center:

- The vehicle is due at the normal mileage or service life interval of maintenance.
- Vehicle accidents such as crash, soaking or scraping the bottom.
- Critical fault alarm messages (e.g., traction battery fault, traction battery overheating, motor and controller overheating, electric system fault, charging port temperature too high) appear on the vehicle's ICM.



## Safety guide

In the event of a vehicle malfunction or accident, please use the emergency devices [See 271 page](#) and follow the operation procedures below to warn the vehicles behind:

1. Park the vehicle in a safe place and turn on hazard warning lights.
2. Take out the warning triangle from the trunk.
3. Take out the warning triangle from the trunk. Place the warning triangle at the rear of the vehicle.

## Guidance for traffic accidents

When the vehicle is severely damaged in an accident, to ensure personal safety, please pay attention to the following warnings:

- Do not touch the HV wiring harness and all high-voltage parts of the vehicle to avoid severe injury from electric shock.
- Do not touch spilled fluid.
- Do not attempt to inspect the vehicle yourself.
- If the vehicle needs to be towed, please contact the XPENG Service Center.
- Secondary energization is prohibited if the vehicle becomes soaked, in which case a short circuit may occur inside the traction battery. In order to ensure personal safety or cause secondary damage to the vehicle, it is necessary to immediately contact the XPENG Service Center to check the traction battery system, and have professionals evaluate the damage of the traction battery.
- If the vehicle emits smoke, please stay away from the vehicle immediately and contact the XPENG Service Center in time.
- If the vehicle is on fire, please stay away from the vehicle immediately and call the police in time. When calling the police, you need to inform that the vehicle is a pure electric vehicle.
- If the ICM shows a traction battery system fault, you should safely pull over, stay away from the vehicle and contact the XPENG Service Center for treatment.



- If anyone in the vehicle is injured, contact first aid according to the degree of injury.
- If the vehicle is involved in an accident such as scraping the bottom or crash, the internal structure of the traction battery may suffer damage, posing a severe safety risk, and it is necessary to immediately contact XPENG service center to inspect the traction battery system and have the damage assessed by a professional.

### Seat Belt

#### Advantage of Wearing Seat Belts Properly

Properly wearing seat belts can restrain the driver and passengers in restricted positions.

After a vehicle collision, properly wearing seat belts can assist other safety systems to absorb the energy generated by the collision at the same time, slowing down the inertia of forward motion of driver and passengers and preventing

them from being thrown forward, while assuring them the best protection by the airbags and minimizing the injury impact.

#### warning

The driver and passengers must wear seat belts properly, otherwise they will be thrown out forward in an accident, which will not only injure themselves but also endanger others in the vehicle.

#### Seat Belt Pre-tensioner

The seat belt pre-tensioner is activated in the event of a severe frontal or side crash, working in tandem with the airbags. It automatically tightens the seat belt webbing, reducing slack in the lap and diagonal parts of the belt, thereby minimizing the forward movement of the vehicle's occupants.



If the pretensioners and airbags are not activated at the time of a crash, it doesn't mean that they are broken. This means that the intensity or type of collision is not enough to activate them.

### **warning**

After an accident, airbags and other related components must be sent for inspection and replaced if necessary. Once a seat belt

pretensioner has been activated, it must be replaced.

### Checking the Seat Belts

To confirm that each seat belt is functioning properly, the following four inspection items shall be conducted:

1. Check the seat belt, buckle and other devices for damage, modification, bleach, strain or dirt.
2. Fasten the seat belt and pull it out quickly at the closest point to the buckle. The buckle shall remain securely locked.
3. Unbuckle the seat belt and retract it to the greatest extent. Check the seat belt for excessive looseness and wear.
4. Pull out the seat belt halfway. Hold the latch and pull the belt forward quickly. The internal locking mechanism of the seat belt will lock automatically.



If any seat belt fails any of the above tests, please contact the XPENG Service Center or Customer Service Center immediately.

### Adjusting the Shoulder Belt Height



1. Adjust the shoulder belt to the proper height by pinching the guide and moving it upward.
2. Release the shoulder belt guide.

3. Pull the seat belt quickly to check whether the guide has been locked.

#### warning

Do not adjust the seat belt height during driving.

### Fastening the Seat Belt





1. Slowly pull out the seat belt, and place it around the entire pelvis, chest, and collarbone, keeping it between the neck and shoulder.
2. Insert the latch into the buckle until it “**clicks**”, to ensure that it is locked into place.
3. Pull the seat belt hard to check if it is fastened.
4. Tighten the seat belt towards the reel.

### Unfastening the Seat Belt



1. Hold the seat belt latch.
2. Press the red button on the belt buckle.
3. Continue to hold the seat belt latch to ensure that the seat belt is slowly retracted.



### Use of Seat Belt by the Pregnant

Wearing a seatbelt properly can effectively reduce injuries to a pregnant woman and her fetus in the event of a collision or sudden stop.



Pregnant woman shall wear the crotch/shoulder belt properly. The shoulder belt should pass over the chest from a suitable position. The lap belt shall pass over the crotch as low as possible and

fit under the bulging abdomen. The safety belt must be flat and exert no pressure on the lower body of pregnant women.





Please consult your doctor.

### Use of Seat Belt by the Disabled

The disabled should also wear seat belts properly during driving.

Please consult your doctor for better advice.

### Seat Belt Indicator Lights

1.  Unfastened driver's seat belt warning indicator
2.  Unfastened front passenger's seat belt warning indicator
3.  Unfastened rear left seat belt warning indicator
4.  Unfastened rear middle seat belt warning indicator
5.  Unfastened rear right seat belt warning indicator



If the front passenger forgets to wear seat belt, the corresponding seat belt indicator on the instrument cluster will flash when the vehicle is static; when the vehicle reaches a certain speed while driving, the corresponding seat belt indicator on the instrument cluster will flash and the instrument cluster will pop up Warning window, accompanied by alarms.

If the rear passenger forgets to wear seat belt, the corresponding seat belt indicator on the instrument cluster will flash.

If all passengers have fastened their seat belts but the indicator is still flashing, re-buckle the seat belts to ensure that they are properly locked.

### Seat Belt Precautions

#### warning

- Everyone in vehicle shall wear the seat belt properly during driving, or there is a high risk of injury or death in the event of an accident.

- Do not press the seat belt against fragile or sharp objects (e.g. pens, keys, glasses); the seat belt's pressure on these objects may cause injury.
- When wearing the seat belt, it must fit the body and not be distorted. The shoulder belt must pass over the middle of the passenger's shoulder and must be attached to the upper body of the passenger and fasten the body tightly. The lap belt shall be around the hip as low as possible. If necessary, pull it down slightly, and adjust its looseness by pulling in the retraction direction.
- One seat belt is for one person only. It is prohibited to use one seat belt together with child by holding him/her on lap.
- In case of any sign of wear, cracking or other damages to the seat belt, please contact XPENG Service Center for replacement.
- Avoid exposing the seat belts to any chemicals, liquids, etc. If any seat belt fails to retract or be removed from the buckle,



please contact XPENG Service Center for troubleshooting as soon as possible.

- Do not add any non-official accessory to the seat belt, including but not limited to the following products: additional latches, strap restrictors, buckle extension connectors, etc., as they may reduce or even disable the seat belt's normal protection.
- Any seat belt shall be fully retracted without dangling if unused. If any seat belt cannot be retracted completely, please contact XPENG Service Center immediately for troubleshooting.
- Do not remove, install, modify or disassemble the seat belts, seat belt retractors, or seat belt anchors by yourself.

### Airbags

#### Overview

The vehicle provides front airbags, side airbags, and far side airbags for the driver and front

passenger, as well as head airbags for the front and rear occupants. If the front seats, seat belts, headrests and steering wheel are properly adjusted, the front airbags provide additional chest and head protection for the front occupants. It should be noted that the airbag system cannot substitute the seat belts. It only provides supplementary protection! Therefore, even if the front airbags are provided, the front occupants must wear seat belts.

#### warning

- Deploying the airbags only provides additional protection in the event of an accident, never rely solely on the protection provided by the airbags!
- The airbag system is able to provide full protection only when the occupant wears the seat belt properly, reducing the risk of injury or death in an accident.
- Do not place a rear-facing child safety seat on the seat with protection from a front airbag. Serious injury or death can occur.



- All occupants must be seated properly, fasten their seat belts before starting the vehicle, and wear seat belts at all times, even during driving in urban areas.
- Occupants must keep 25 cm away from airbags and shall not place their hands, feet, etc. on the airbag identification locations, or they may be injured when the airbags are deployed.
- Do not install any radio device by yourself, or airbags may work improperly. If necessary, contact XPENG Service Center.

## Airbag Positions

The airbags are located in the areas shown in the figure below. The air bag warning tag is stucked on the sun visor.

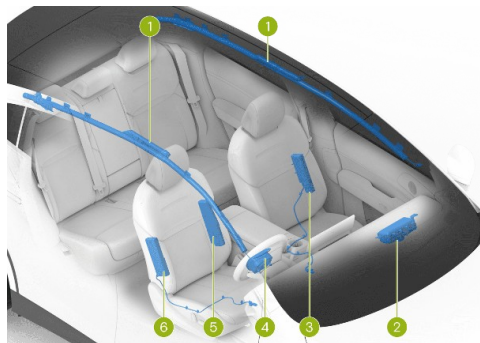

1. Left/Right side curtain airbag
2. Passenger airbag
3. Front side airbag
4. Driver airbag
5. Far side airbag
6. Front side airbag



### **i** Tips

Airbags are not substitutes for seat belts. Seat belts can reduce the risk of serious injury or death in the event of an accident, whether the airbag is triggered or not. So the seatbelt must be worn correctly. Airbags can only provide protection when triggered, and they may not be triggered in all types of accidents.

### **Airbag Fault Indicator**

The indicator light “” on the instrument cluster will come on for a few seconds when the vehicle is powered on and go off after system self-inspection. If the indicator does not go off after the system self-inspection or goes off and then comes on again or stays on, it indicates the airbag system is faulty. Please contact XPENG Service Center for troubleshooting as soon as possible.

### **How Do Airbags Work**

The airbag deployment does not depend on the driving speed, but on the collision strength detected by the collision sensors. The airbag may not deploy when the impact force of the collision is absorbed or dispersed into the body; However, sometimes the airbag may deploy depending on the different collision conditions. Therefore, the airbag deployment should not be judged based on the vehicle's damage degree.

The airbag may deploy in the following situations:

- When crossing a deep pit, the vehicle front hits the ground.
- The vehicle hits a prominence, kerb, etc.
- The vehicle front hits the ground when driving down a steep hill.

The airbag may not deploy in the following situations:

- The vehicle hits a concrete post, tree, or other long, thin object.



- The vehicle rear-ends into the underside of a truck.
- The vehicle is rear-ended by other vehicles.
- The vehicle overturns or rolls sideways.
- The vehicle collides with walls or vehicles in a non-front way.

The airbags deploy instantly and forcefully with a loud bang. The deployed airbags and seat belts can restrain the occupants' movement to reduce the risk of injury.

### Impact of the Airbag Deployment

When deployed, airbags will release gas and powder that may irritate your skin and eyes. At this time, get off the vehicle timely on the premise of safety. If you are unable to do so, open the window or door to keep the cabin ventilated.

If the powder comes in contact with your eyes or skin, rinse with water immediately. Seek medical advice in case of severe discomfort.

After deployment, the airbags will retract to provide the occupants with a progressive shock absorbing effect, avoiding the driver's forward vision from being obstructed.

#### warning

- Airbags can only be triggered once. The triggered airbags and any affected system components should be replaced as soon as possible by XPENG Service Center.
- Airbags and related systems may be faulty even if they are not triggered in an accident. In this case, please contact XPENG Service Center for troubleshooting.
- XPENG Service Center has the necessary tools, diagnostic tool, repair materials and qualified technical professionals. The maintenance and modification of the vehicle shall be carried out by the XPENG Service Center.



### warning

- Do not use any airbag components removed from end-of-life vehicles or any recycled airbag components. The deploying space of the front airbags shall be free of any objects that would prevent the airbags from deploying in the event of a front collision.
- Do not install a cup holder or phone bracket on the airbag cover or in any position within the airbag deploying space.
- Front passenger must not carry child, pet or objects that occupy the airbag deployment space. Both adults and children must follow this regulation.
- Do not attach any objects (e.g., portable navigation devices) to the front windshield glass above the passenger airbags.
- Do not cover or attach anything to the steering wheel or the identification surface of the front passenger side airbag components, or make any modification to these areas.

- Do not stack items on the front passenger seat, as they may be bounced by airbags in the event of emergency braking, injuring occupants.

### warning

- Do not use seat covers, which would limit the deployment of the side airbags in the event of an accident and reduce the accuracy of the system detection.
- Do not modify the airbag cover or add any parts near it. Passengers must not lean their heads against the doors. Otherwise, they be injured by the air curtain (when deployed).
- Passengers must not place their feet, knees, or any other part of their body over or near the airbags. Doing so may prevent the airbags from deploying correctly or may cause fractures or other injuries to occupants if the airbags deploy.
- Do not place any object above or near the front airbags, the sides of the front seats, above the canopy on the vehicle





1. Front passenger airbag status indicator\*(If applicable)
2. Front passenger airbag on\*(If applicable)
3. Front passenger airbag off\*(If applicable)
4. Front passenger airbag switch\*(If applicable)

The front passenger airbag is on by default and can be turned off/on\*(If applicable) in the following two ways:

1. Tap the front passenger airbag status indicator on the status bar, then go to the switch setting interface.
2. Passenger Airbag OFF/ON can be turned on/off at the “→**Drive**”interface of central control panel.

### 警告

- Do not place a rear-facing child seat on the seat with an active frontal airbag. Death or serious injury to the child in the seat can occur.

- Be sure to select an appropriate child safety seat for the child based on his/her age, height and weight.
- One child seat is for only one child. Never constrain multiple children into one child seat with the seat belt.
- Under no circumstances should a child or infant be carried in the occupant's arms during driving.
- Never leave a child unattended in the child seat.
- Never leave children unprotected in a vehicle. Always keep children in the correct seating position during driving. Never stand in the vehicle or kneel on the seat. If an accident occurs under these circumstances, it could be fatal to children and others.
- Any child seat that has been applied forces in an accident must be replaced.
- \*This function is not available in Australia.



### Recommended Types Of Child Seats

Both ECE-R44 and ECE-R129 standards apply to child seats in the country where the user is located.

ECE-R129 classification is based on a child height.

Child stature	Manufacturer	Type	Accessory
40cm-105cm	Dorel Europe	Maxi-Cosi pearl 360 & FamilyFix 360 base	ISOFIX+Support Leg
61cm-105cm	HTS BeSafe	iZi Kid X3 i-Size	ISOFIX+Support Leg
100cm-150cm	Britax Romer	Kidfix i-Size*	ISOFIX+Belt

\*.For the best protection, it is recommended to use this child restraint system with the included backrest and be sure to attach the seat belt through Secure Guard and XP-pad.

ECE-R44 classification is based on a child weight.

Child weight	Manufacturer	Type	Accessory
22kg-36kg	Nania	H6	Belt

Only a child seat that is compliant might be used in the vehicle.



	Seating position						
seating position	front left	front centre	front right ①		2nd row left	2nd row centre	2nd row right
			with front passenger airbag activated	with front passenger airbag deactivated			
Seating position suitable for universal belted (yes/no)	No	No	Yes Forward facing only	Yes	Yes	Yes	Yes
I-Size seating position (yes/no)	No	No	No	No	Yes	No	Yes



Seating position suitable for lateral fixture (L1/L2)	No	No	No	No	No	No	No
Largest suitable rearward facing fixture (R1/R2X/R2/R3)	No	No	No	No	R1/R2X/R2/R3	No	R1/R2X/R2/R3
Largest suitable forward facing fixture (F1/F2X/F2/F3)	No	No	No	No	F1/F2X/F2/F3	No	F1/F2X/F2/F3



Largest suitable booster fixture(B2/B3)	No	No	B2/B3*	B2/B3*	B2/B3	B2/B3*	B2/B3
<ul style="list-style-type: none"><li>• *Only applicable for installation with seat belt.</li><li>• During the installation of the CRS, the backrest angle of seats should be adjusted reasonably to ensure that the CRS remains stable.</li><li>• During the installation of the CRS, the height of the headrest should be adjusted reasonably or the headrest should be removed to avoid interference with the CRS.Do not remove the head restraint when using a booster cushion with no backrest.</li><li>• ①: When installing a CRS on the front passenger seat, adjust the front passenger seat as high as possible to securely install the CRS.</li></ul>							



### For Tall Children

If a child is too tall to use a child safety seat, but too short to safely use a standard seat belt, purchase and properly use a child's booster cushion that meets the relevant regulations or standards. Use a child's booster cushion to increase the child sitting height, so that the shoulder belt stays right in the middle of the child's shoulder and the lap belt is lowered to the crotch.

### Child Safety Seat Installation

There are two general methods of installing child safety seats:

1. Seatbelt fixed child safety seats: This kind of seats should be secured with the vehicle's seat belts.
2. ISOFIX fixed child safety seats: This kind of seats can be secured to the anchor bars built into the rear seats of the vehicle.

### Installing a Seatbelt Fixed Child Safety Seat



1. Place the child safety seat on the seat, and pull out the seat belt completely. Fasten and buckle the seat belt according to the child safety seat manufacturer's instructions.



2. Retract the seat belt, push the child safety seat firmly into the seat while tightening the seat belt.
3. If the child safety seat has an upper tether, attach the tether to the seat backrest.

### ISOFIX Anchor Points

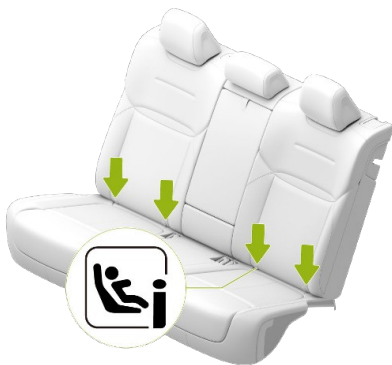

The ISOFIX anchorages are located between the backrests and cushions of the rear left and right

seats. The exact location of each anchorage is marked as above (as shown in the figure).

- ▶ The anchor points are located directly below the child seat identification mark.
- ▶ The upper anchoring points are located at the back of the rear side seat backrests. When installing CRS, the anchor point of the corresponding side should be used. If the CRS is installed on the left seat, the upper anchor point must be the left one. It is forbidden to use the right one.



## Installing an ISOFIX Child Safety Seat

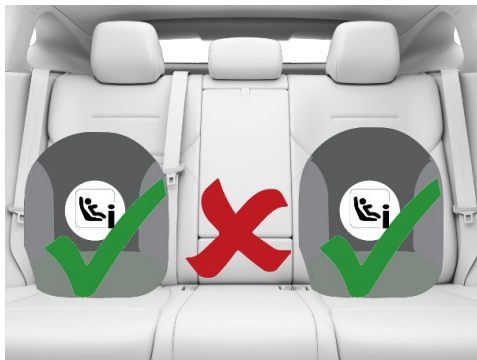

1. Place the child safety seat in the rear left/right seat.

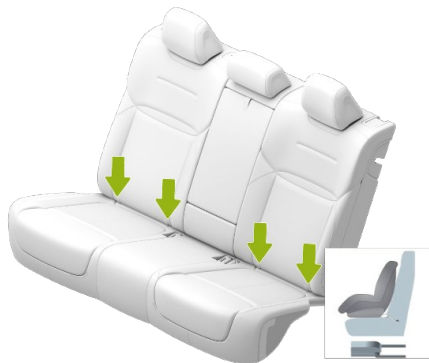

2. Insert the lower anchor bracket of the child safety seat into the ISOFIX anchorages according to the child seat manufacturer's instructions.

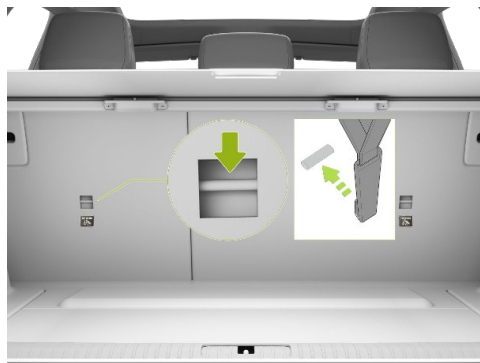

3. Thread the top tether strap of the child safety seat through the headrest, pull it to the back of the backrest, connect the hook of the strap to the anchor point, and tighten the strap.



## Notes on installing a child restraint system

### warning

When installing a CRS on the front passenger seat, the below instructions can be followed if needed:

- Adjust the front passenger seat to its fully rear position.
- Adjust the front passenger seat as high as possible to securely install the child safety seat.
- The height of the vehicle seat belt can be adjusted if necessary to ensure that the vehicle seat belt passes through the belt guide correctly on the child seat without bending.
- The front passenger airbag must be activated immediately after removing the child seat from the seat.

When installing a child seat in the rear seat, the following instructions need to be followed:

- Please adjust the frontal seats in fore/aft and height, or adjust the seatback to ensure there is no interaction between the frontal seats and the CRS/Child.
- During the installation of the child seat, the height of the headrest should be adjusted reasonably or the headrest should be removed to avoid interference with the child safety seat. Do not remove the head restraint when using a booster cushion with no backrest.

## Checking the Child Safety Seat

After installing the child safety seat, check the seat for looseness:

1. Secure the child safety seat along with the seat belt and try to move/shake the seat from side to side, and from front to back.
2. If the seat can move more than 2.5 cm, indicating that it is too loose, fasten the seat belt or reinstall it to the ISOFIX anchorage.



3. If you cannot fasten the seat, try another seat position or replace the seat.

### warning

- Never place a rear-facing child safety seat in a seat with an activated airbag, or it will pose a serious risk of injury or death.
- The youngest children (under two years as minimum) do not have a fully developed spine and neck. This is why it is strongly recommended to install them in rearward facing child seat. The latest regulation of child seat impose the rearward facing child seat to accommodate child of 15 months minimum. A variety of child seat can accommodate even older, taller children (see recommended child seat in page 159).
- Infants and toddlers should never be allowed to sit on parents' laps. All children should be restrained in appropriate child safety seats at all times.
- To ensure a safe ride for your child, be sure to follow all instructions detailed in this

manual as well as those provided by the child safety seat manufacturer.

- Do not use extensions for belts of seats installed with child safety seats or booster.

### warning

- For a tall child, ensure that the child's head is supported and that the child seat belt is properly adjusted and secured. The shoulder part of the seat belt must be fastened away from the face and neck, and the lap section must also be fastened away from the abdomen.
- Never attach two child safety seats to one anchorage, as one anchorage may not be firm enough to secure both seats in the event of a collision.
- The anchor points for the child protection device can only bear the load from a properly installed child protection device. Under no circumstances, shall the child protection device be used for adult seat



belts, wiring harnesses or the installation of other items or equipment.

- Always check safety harnesses and tethers for damage and wear.
- Do not leave children alone in the car even if they have been put in child safety seats.
- Never use a child safety seat that has been modified, damaged, and in a car accident. Have the seat checked or replaced in accordance with the child seat manufacturer's instructions.

## Childproof E-lock

The vehicle has childproof locks on both rear doors. When the lock is turned on, the doors can't be opened by the interior door handles. This can prevent children from opening rear doors accidentally and reduce the accident risk.

- The child safety lock can be turned on/off through the shortcut menu interface [See 32 page](#) on the CID.

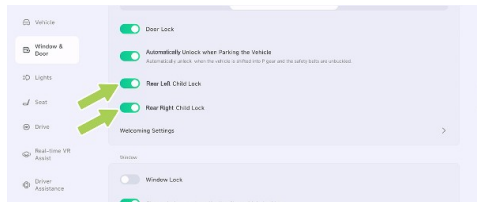

- Tap “🚗 → **Window & Door**” on the CID to turn on/off the child safety lock.

### **i** Tips

It is recommended that you turn childproof lock on whenever children are seated in the rear seats.

### **⚠** warning

When the childproof lock function is fully turned on, the rear doors cannot be opened from inside. Please do not leave children alone in the car.



## Secondary Collision Mitigation (SCM)

### Introduction

Secondary Collision Mitigation: After the first collision, this function will automatically apply brake to slow down or stop the vehicle, thus minimizing the risk of a secondary collision and mitigating the damages.

## Alcolock

### Introduction

The vehicle is equipped with an communication Alcolock, which can be installed with a LIN communication Alcolock (the port must meet the 50436-4 2-22 version specification).

## Braking Assist

### Introduction

#### ESP (Electronic Stability Program)

By identifying the driving state of the vehicle through sensors (such as understeering, oversteering or drive wheel slipping), ESP can apply targeted braking intervention or limit driving torque to effectively reduce the risk of side slip or tail flick, so as to ensure the driving stability of the vehicle.

#### Turning on/off

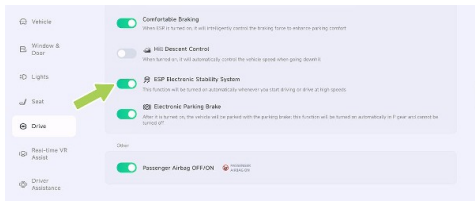



Tap “ → Drive” on the CID to turn on or off the ESP.

## Tips

- After the vehicle is powered on, the ESP function is automatically activated by default.
- When the vehicle speed is higher than 80km/h, if the ESP is in off state, the ESP function will automatically be enabled.
- The ESP function, if deactivated, will be automatically activated when the steering mode or the creep mode is entered.

## warning

- ESP cannot prevent the accidents caused by dangerous driving or emergency steering at high speed.
- If the ESP malfunctions, please contact the XPENG Service Center immediately for inspection and repair.

## ABS (Anti-lock Brake System)

ABS prevents wheel lockup when applying maximum braking force. In most road conditions, it can improve the steering control performance of the vehicle in emergency brake.

In emergency brake, ABS continuously monitors the speed of each wheel and adjusts the brake pressure based on the lock state.

When ABS intervenes in driving, you may feel the brake pedal vibration, and you can subjectively drive without panic based on the road conditions.

When ABS fails, the basic braking function remains normal and is not affected by ABS fault, but the braking distance will increase.

## warning

The driver shall always keep a safe distance from the vehicle in front and be aware of any dangerous situations during driving. Although ABS can improve the braking distance, it cannot go beyond the physical law, nor can



it prevent the danger caused by tire slip (Like when there is water layer between the road and the tire to prevent the tire from directly contacting the road).

### Emergency Brake

In emergency, completely press the brake pedal and maintain stable pressure. ABS prevents the wheel lockup and ensures safe parking by changing the braking pressure applied to each wheel based on the available braking force.

### dTCS(Distributed Traction Control System )

When the vehicle starts or accelerates rapidly on icy road and other slippery roads, the drive wheels may slip. dTCS controls brake pressure and vehicle torque output to minimize the wheel spin.

#### **i** Tips

When the vehicle is trapped (e.g. stuck in a muddy road or a deep snowy road), please control the depth of the accelerator pedal, and

do not depress the accelerator pedal to the floor all the time.

#### **!** caution

G6 is not a professional off-road vehicle, please do not drive it on undulating off-road surfaces or muddy surfaces. dTCS function does not always help the vehicle get out of trouble on any muddy roads successfully.

### EBD (Electronic Brake Distribution)

EBD is a part of ABS, which balances the braking distribution between the front and rear wheels based on the load on the vehicle during regular braking.

EBD will distribute the force generated by the braking system properly to 4 wheels based on the adhesion between each wheel and the ground, to get the optimal efficiency of the braking force, which can significantly shorten the braking distance, and keep the vehicle stable during braking, improving the driving safety.



## EBA (Electronic Brake Assist)

In an emergency, quickly press and hold the brake pedal, EBA will generate a braking pressure higher than normal braking, allowing the braking system to generate the pressure required for maximum deceleration of the vehicle in the shortest possible time for the shortest braking distance.

### warning

EBA can improve the driving safety, but it cannot be beyond the kinematics law. Please adjust the speed according to the road conditions and the traffic speed.

## HDC (Hill Descent Control)

HDC is a cruise control function that helps the driver to go downhill at a constant speed, alleviating foot fatigue caused by constantly pressing the brake pedal.

### Turning on/off

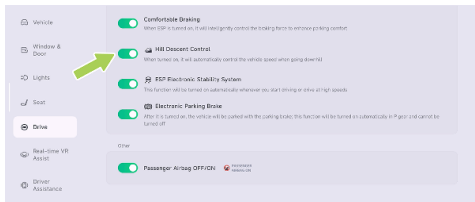

Tap “ → Drive” on the CID to turn on or off HDC.

When the vehicle speed is higher than 8km/h but less than 35km/h, the HDC function can be used. If the brake pedal or accelerator pedal is pressed during HDC operation, the function will exit and the driver needs to take over the vehicle. When the vehicle speed is higher than 60km/h, the function completely exits and entry is prohibited.

### Tips

- HDC can work on slopes with gradient greater than or equal to 5%.



- Conditions for activating HDC: The vehicle speed is below 35km/h; The brake disc temperature is normal. The ESP system works properly.

### warning

HDC can actively keep the vehicle descending at a constant speed, but it can not go beyond the laws of kinematics. For safety reasons, the driver should apply the brake in time according to the actual situation of the vehicle to avoid accidents caused by the going downhill too fast.

### HHC (Hill Hold Control)

When the vehicle starts from a still state on a slope higher than 5%, the driver releases the brake pedal and presses the accelerator pedal, the power output is insufficient to prevent the vehicle from sliding before starting (the vehicle has a tendency to slide) during the period. HHC will keep the braking force that the driver

depresses on the brake pedal and keeps it stationary to prevent the vehicle from sliding.

### Tips

- HHC function is only applicable to: when the vehicle is at D or R gear, the braking force generated before the brake pedal is pressed and released is sufficient to keep the vehicle on a slope.
- HHC function can last for about 1 second, and the braking pressure holding time will be released in advance or extended properly according to the driver and the slope.

### warning

HHC can provide brake assistance, but it must follow the kinematics law. For safety reasons, the driver shall apply the brake in time according to the actual situation of the vehicle to avoid accidents caused by sliding.



## I-key

### Introduction



#### 1. Lock button

Press and release this button to lock the vehicle.

#### **i** Tips

- When the driver seat is unoccupied, the vehicle is engaged in P gear and all doors (including the front hatch and trunk) are closed, the vehicle can be locked.
- After locking, the turn signal lights will flash once and the horn will sound once (if set).

#### 2. Trunk opening/closing button

Press this button twice to open or close the trunk.

#### 3. Unlock button

Press this button briefly to unlock the vehicle.

#### **i** Tips

After unlocking, the turn signal light will flash twice and the horn will sound twice (if set).

#### 4. Charging port cover opening/closing button



Press this button twice to open or close the charging port cover.

### Operation

#### Setting the feedback of unlocking and locking outside the vehicle

Unlocking Feedback can be set on the “” → **Window&Door**” interface of the central control panel.

#### Replacement of I-key battery



1. Press the trim cover unlock button and remove the trim cover as indicated by the arrow.

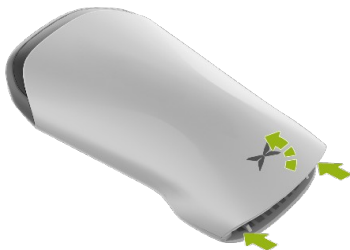

2. Carefully flip the cover upwards along both edges of the back cover.



3. Remove the key battery. Battery type: CR2032H, Panasonic or Maxell.
4. Install the battery in reverse order of removal. Place the key battery “+” (positive) facing up.



### Cellphone App Bluetooth key

#### Introduction

Cellphone App Bluetooth key can be used to check the vehicle status and control some of the vehicle functions remotely. After Bluetooth pairing, you can use the remote parking [See 86 page](#) and PEPS [See 158 page](#) on your cellphone.

#### **i** Tips

- You can use the cellphone Bluetooth key in the garage and other places without network.
- The XPENG vehicle is equipped with both media Bluetooth and key Bluetooth. The cellphone App Bluetooth key connects to “**key Bluetooth**”, without pairing in the CID.

#### Operation

##### Activating cellphone App Bluetooth key

When the network of the cellphone and the vehicle is normal, tap the “**XPENG Page→Key Activation**” in the cellphone App interface to activate the cellphone App Bluetooth key.

#### **i** Tips

After successful activation of the cellphone App Bluetooth key, the original “**Key Activation**” button changes into the “**Vehicle Locking**” button.

##### Vehicle unlocking and starting

1. If the Bluetooth is paired, tap the “**XPENG Page→Vehicle Lock**” to unlock the vehicle, and the vehicle can be started within 20min after the gear is engaged.
2. If Bluetooth is not paired but there is network connection, tap the “**XPENG Page→Vehicle Lock**”:



- Tap “**Unlock Doors Only**” to unlock the doors. Tap “**Remote Start**” again and depress the brake pedal within 2min to start the vehicle.
- Tap “**Unlock and Start**” to unlock and start the vehicle remotely. Please depress the brake pedal to start the vehicle within 2min.

## Authorizing other vehicle and Bluetooth key

1. The authorized person shall download the cellphone App and register in advance, and then log in the account.
2. The authorizer taps “**Settings→Authorization**” in his/her cellphone App interface to add the account owned by the authorized person.
3. The authorized person accepts the authorization on the cellphone App and activates the cellphone App Bluetooth key to control the vehicle.

### Tips

- The above operations require a connected Internet and there may be delayed feedback.

If there is any problem, please repeat the operation again.

- 5 users can be authorized at most.

## PEPS

### Introduction





The vehicle will be unlocked automatically when you are near a certain range of the vehicle with the cellphone App Bluetooth key carried, and will be locked automatically when you leave.

### Operation

#### Function activation

When the network of the cellphone and the vehicle is normal, tap the **“XPENG Page→Settings→Key Management”** in the cellphone App interface to turn on the **“Walk-in Unlocking”** and **“Walk-away Locking”**.

The **“Walk-in Unlocking”** and **“Walk-away Locking”** functions shall be reset after reactivating the cellphone App Bluetooth key, reinstalling the cellphone App or logging in by a new cellphone.

#### Function usage

##### Vehicle unlocking

When you approach the vehicle in a distance with your cellphone, the vehicle will be

unlocked and the door handle will be extended automatically. If the door handle is not extended, pull the handle directly to unlock the door.

##### Vehicle starting

If the cellphone App Bluetooth key being paired with vehicle Bluetooth is left in the vehicle, depress the brake pedal to start the vehicle.

##### Vehicle locking

When the vehicle is in P gear and all doors (including the front hood and trunk lid) are closed, carry your cellphone away from the vehicle and the vehicle will be locked automatically.

#### **caution**

Please make sure the vehicle is locked before leaving even if the **“Walk-away Locking”** function is activated.



## i Tips

- Before using the cellphone App Bluetooth key, please make sure the **“Bluetooth”** function of your cellphone is turned on.
- In the open field, Bluetooth can be paired within up to 30 m around the vehicle, which may vary due to the influence of cellphone Bluetooth hardware, human body blocking, and environmental interference factors.
- Please keep the cellphone App running in the background after unlocking the vehicle, otherwise you may not be able to start the vehicle or lock the vehicle.
- The vehicle Bluetooth can be paired with 1 cellphone App Bluetooth key only. When more than one cellphone App Bluetooth key is near the vehicle at the same time, the cellphone App Bluetooth key that unlocks the vehicle first will automatically log in the account on CID.

When the walk-in unlocking function fails or the gear engagement fails, please tap the

**“XPENG Page”** in the cellphone App interface to check the Bluetooth pairing, then release the brake pedal first, and retry to depress the brake pedal and engage into a gear. If the Bluetooth is still not paired, please tap the **“XPENG Page→Settings→Key Inspection”** in the cellphone App interface to follow the instructions for troubleshooting.

When the vehicle needs to be locked temporarily because there is a passenger in the vehicle, please make sure that all the doors (including the front hood and trunk lid) are closed first, and then tap the **“XPENG Page→Temporary Parking”** in the cellphone App interface to turn on the function. The vehicle will be locked, but the A/C and the CID will continue to work. The passenger in the vehicle can get off at any time by pressing the door electric release switch.

If the vehicle is locked by the I-key or the cellphone App Bluetooth key, the passengers in the vehicle can still press the electric release switch to get off, but the vehicle anti-theft alarm system will be triggered at this time. It



is recommended to unlock the door before triggering the alarm to facilitate passengers to get off the vehicle.

### Caution and limitation

The automatic unlocking and locking function of the cellphone App Bluetooth key will be deactivated when:

- The cellphone is in low battery level and low battery mode.
- Cellphone App stops running in the background.
- Bluetooth signal is unstable or abnormally disconnected.
- Bluetooth signal is blocked by obstacles (such as backpack, human body, wall, etc.), resulting in abnormal ranging.
- Cellphone App is not opened after cellphone restart or system upgrade.

After the above problems occur, please try to:

- Clear the blockage between the cellphone and the body, such as taking out the cellphone from the pocket, backpack.
- Open the cellphone App.
- Restart the cellphone App.

### Flush door handle

#### Introduction





When the vehicle is unlocked, the door handles will automatically extend and can be pulled to open the door; When the vehicle is locked, the door handles will automatically fold.

Tap “☰ → **Windows & Door**” on the CID to turn on/off the automatic door handle unfolding function.

## **i** Tips

If the door handle retracts/extends more than 8 times in 1 minute, the tamperproof mode will be triggered to disable the door handle operation. The door handle function will be restored after 20s.

## Electric door opening and closing

### Introduction

The doors can be unlocked/locked in the following ways:

- I-key [See 154 page](#)
- Cellphone App bluetooth key [See 157 page](#)

- PEPS [See 158 page](#)
- Door electric release switch
- Door lock switch
- Emergency opening [See 284 page](#)
- Auto unlocking at collision

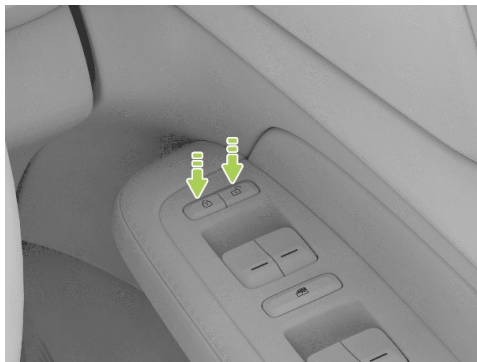

## Operation

### Door lock switch





The door lock switch is located on the driver side door armrest:

-  Lock: When all doors (including the front hood and trunk lid) are closed, press this button to lock the vehicle.
-  Unlock: Press this button to unlock the vehicle.

### Door electric release switch



When the vehicle is stationary, press the door electric release switch on the side of the door armrest to open the corresponding door.

### Auto unlocking at collision

When the vehicle is involved in a serious collision resulting in the airbag deployment, the vehicle will be unlocked automatically immediately after 3s.

#### Tips

In the case of auto unlocking at collision, the turn signal lights will flash, and stop flashing when the vehicle is powered off or the hazard warning light button is pressed.

## Trunk opening and closing

### Introduction

The trunk can be opened and closed in the following ways:

- X-Peng voice



- I-key [See 154 page](#)
- Cellphone App bluetooth key [See 157 page](#)
- Central control panel
  - 3D central control panel [See 51 page](#)
  - Shortcut panel [See 32 page](#)
  - Bottom status bar (if set) [See 31 page](#)
  - “→**Window&Door**”Interface.
- Trunk external switch
- Trunk internal switch
  - Opening angle adjustment
- Emergency opening [See 287 page](#)

## **i** Tips

It can be turned on with the vehicle is engaged in P gear.

## Operation

### Trunk control by external switch

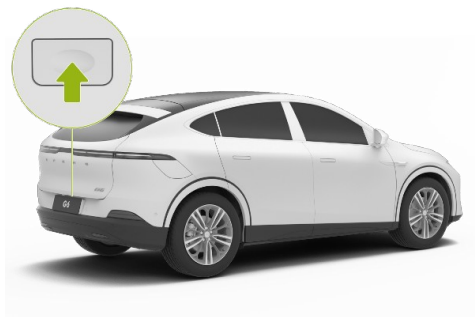

When the vehicle is unlocked, press the external switch to open or close the trunk automatically.



### Trunk control by internal switch



- Press the internal switch to open or close the trunk, or to pause the trunk that is opening or closing.
- Press down the trunk with force in the direction of closing, the vehicle will detect the pressure and close the trunk automatically.

### Adjustment of trunk opening angle

The trunk opening angle can be adjusted via the CID or the trunk internal switch.

Open the trunk to the desired angle, press and hold the trunk internal switch until an audible feedback is heard, and the trunk opening angle is set.

#### **i** Tips

When the switch is pressed and held to open the trunk at an angle lower than the lowest angle allowed to be set, the trunk opening angle will be set to the lowest value.

The Trunk Unfolding Angle Memory can be set on the “Window&Door” interface of the central control panel.

### Trunk anti-pinch protection

When there is an obstacle in the way of opening and closing the trunk, the trunk will move back for a certain distance.



## warning

When opening and closing the trunk, make sure that there are no people or other obstacles within the movement range of the trunk to avoid the personal injury or vehicle damage.

## Welcome mode

### Introduction

When the front occupant unfastens the seat belt and opens the door, the seat will move back to a position that is convenient for getting out of the vehicle, and the next time the occupant gets in the vehicle and closes the door, the seat will return to the memorized position. With the welcome sound effect enabled, when the driver enters the vehicle and closes the door, the welcome sound will be played.

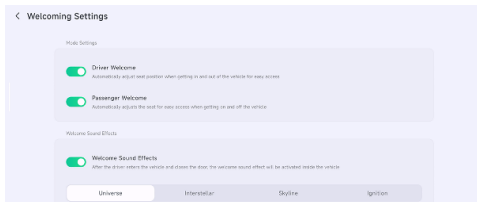

Set the greeting function and sound effect on the “→**Window&Door**→**Welcoming Settings**” interface of the central control panel.

### Tips

- If the seat backrest inclination angle is large, moving the seat backwards may affect the rear passengers, and the welcome function will not be activated at this time.
- If the seat is moved backwards convenient for people to get out of the vehicle, the welcome function will not be activated at this time.



## A/C operation

### Introduction





1. Front/rear A/C switching
  - Tap “**Front/Rear**” to switch the front/rear A/C setting interface.
  - It indicates the front/rear A/C ON status.
2. Driver's seat A/C components
  - It indicates the current temperature and air volume of the driver's seat A/C.
  - Adjust the driver's seat A/C.
3. Adjust the temperature of driver's seat
4. A/C mode



- Tap “**SYNC**” to turn on/off the synchronous adjustment of driver's seat temperature and front passenger's seat temperature.

## **i** Tips

When the energy-saving mode [See 172 page](#) is selected, the temperature synchronization is automatically turned on.

- A/C: Turn on the rear A/C for cooling or heating.
  - AUTO: After it is turned on, the A/C will automatically control according to the set temperature.
5. Blowing mode
- : Window blowing.
  - : Air-to-face.
  - : Air-to-footwell mode.

## **i** Tips

- Red air indicates that the set temperature is higher than the interior temperature, and the A/C is heating.
  - Blue air indicates that the set temperature is lower than the interior temperature, and the A/C is refrigerating.
  - Grayish-white air indicates that the set temperature is close to the interior temperature, and the A/C is maintaining the temperature.
6. • When the A/C is turned on, tap to open/close the air outlet, and drag to adjust the wind direction of the air outlet.
- Air outlet modes can be selected: Free Vent, One -Way Vent, Symmetric Vent and Sweep.
7. Turning on/off the front A/C

## **i** Tips

It is recommended not to turn on the A/C system during charging.



- Adjust the air volume
- Heating and defrosting/internal and external circulation

- : Turn on/off front windshield defrosting.
- : Turn on/off the rear windshield heater for defrosting and exterior rearview mirror heater for defrosting.

### Tips

- Once started, if not manually turned off, the heating function will be automatically turned off by the system after 14 minutes of heating.
- During heating, if the 12V battery voltage is lower than 9V, the system will automatically turn off the heating function.

### caution

- When the vehicle is not started, it is not allowed to use the heating and defrosting function for a long time.

This could avoid low battery charge of 12V battery, so the vehicle cannot be started.

- When the heating and defrosting function is turned on, do not touch it with your hands.

- : Switch between internal and external circulation.

### 10. Rapid temperature control/intelligent A/C

- Rapid cooling: After it is turned on, the A/C temperature will be adjusted to the minimum and the air volume to the maximum, and the seat ventilation function will be automatically activated.
- Rapid heating: After it is turned on, the A/C temperature and air volume will be adjusted to the maximum, and the seat heating and steering wheel heating functions will be automatically activated.



## **i** Tips

To improve the comfort, it is recommended to remotely turn on the A/C for rapid cooling/heating through mobile App in summer (high temperature) or winter (low temperature).

- Intelligent mode [See 172 page](#).
11. Adjust the front passenger's seat temperature
  12. Front passenger's seat A/C components
    - It indicates the current temperature and air volume of the front passenger's seat A/C.
    - Adjust the front passenger's seat A/C.
  13. PM2.5 [See 173 page](#)
    - Tap the card to turn on/off air purification.
    - It displays the air quality inside and outside the vehicle.



## Rear A/C setting interface

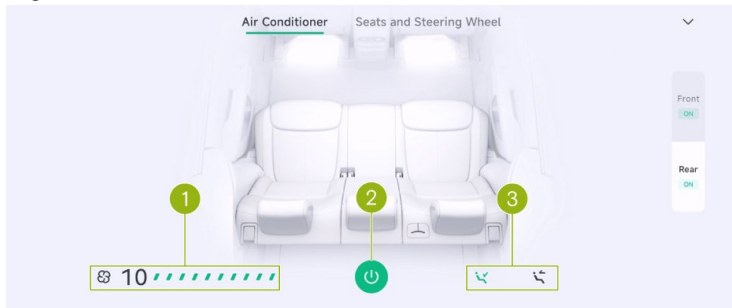

1. Adjust the air volume
2. Turn on/off the rear A/C
3. Blowing mode
  - : Rear air-to-face mode .
  - : Rear air-to-footwell.

### **i** Tips

The A/C can also be controlled via the steering wheel and voice assistant.



## A/C smart mode

### Operation

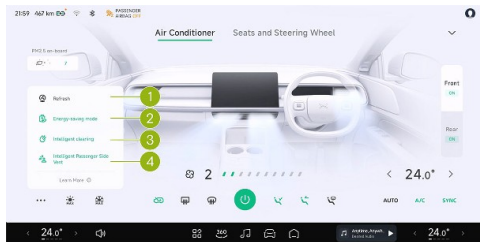

On the A/C setting interface, tap “...” to select different intelligent A/C modes according to the situation.

#### Refresh

This function is suitable for quickly removing the smell of a new delivered vehicle at the beginning of the vehicle's life, or when an abnormal smell is detected in the vehicle while driving. After

this mode is turned on, it will provide continuous ventilation for 180s and improve driving comfort.

#### Energy-saving mode

After the Energy-saving mode is turned on, the A/C will run in a more power-saving mode, reducing the power consumption of the A/C and extending the range. After it is turned on, the A/C cooling or heating performance will be affected.

#### Intelligent cleaning

After the vehicle is unlocked, it can intelligently detect water accumulation in the A/C system and enable the self-drying function to reduce bacteria breeding and reduce the probability of odor in the vehicle.

#### **i** Tips

After it is turned on, a certain amount of power will be consumed and the driving range will be slightly affected.



## Intelligent Passenger Side Vent

At seats other than the driver's one, the A/C air outlet automatically opens or closes depending on whether the seat is occupied, so as to reduce the power consumption of the A/C and prolong the driving range.

## Air purification

### Introduction

The air purification function obtains the air quality inside and outside the vehicle through a sensor and network, and displays it on the A/C interface. When the air quality in the vehicle is poor, it will actively remind you to enable the air purification function.

The air purification can be turned on in the following ways:

1. Say to X-Peng: air purification.



2. Tap the area below PM2.5 on the central control panel to start purification.
3. After AUTO is set, the purification function will be automatically started when the air inside the vehicle is detected as moderate pollution or worse.

You can exit air purification in any of the following ways:

1. When the air quality inside the vehicle is good or below, it will stop automatically for 30s.
2. During purification, tap the air purification icon in the lower right corner of the A/C control interface again to stop purifying.



3. During air purification, turn off the A/C and turn on the front defroster to exit purification.
4. During air purification, turn on rapid heating, rapid cooling and intelligent deodorization to exit purification.

### Seat

#### Adjustable by switch

##### Driver's/front passenger's seat switch



1. Seat/cushion adjustment switch
  - Forward/backward adjustment: Move the switch forward and backward.



- Seat height adjustment: Move the rear part of the switch upward and downward.
2. Backrest inclination adjustment switch

### **i** Tips

The operations of the front passenger seat is the same as that of the driver seat, but cushion height adjustment is not available.

### Rear seat backrest adjustment switch



The rear seat cushions are equipped with seat backrest adjustment buttons on both sides, making it easy for rear passengers to adjust the angle of the seat backrest.



## Rear seat fold-down switch



1. Pull the seat backrest release lever.
2. Incline the seat backrest forward.
3. To restore the seat backrest, pull out the seat belt, lift the seat backrest upwards and push it backwards to lock it.

## caution

Prior to the inclination of the seat backrest, items on the rear seats should be removed so as not to interfere with the inclination of seat backrest.

## Front/rear headrest adjustment switch





- Down: Press and hold the locking button and push down the headrest to the desired position.
- Up: Lift up the headrest directly to the desired position.

 **caution**

The lowest position of headrest is not suitable for use. The headrest should not be adjusted to the lowest position when the seat is occupied.



## Seat adjustment parameters

In the initial position, the adjustment parameters of the seat are as follows:

	Item	Parameters
Driver's seat	Forward/backward adjustment	Total travel 260mm,: 212mm forward, 48mm backward
	Up/down adjustment	Total travel 69.5mm: 35.6mm up, 33.9mm down
	Backrest adjustment	Total travel 91°: 16° forward, 75° backward
Front passenger's seat	Forward/backward adjustment	Total travel 260mm,: 212mm forward, 48mm backward
	Up/down adjustment	Total travel 69.5mm: 35.6mm up, 33.9mm down
	Backrest adjustment	Total travel 91°: 16° forward, 75° backward



## Adjustable by central control panel

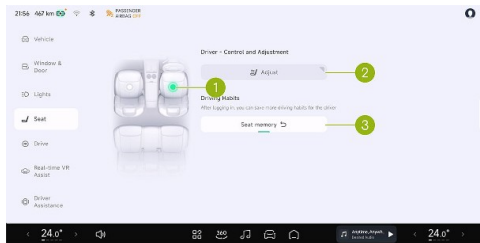

Adjust the seat position on the “ → **Seat**” interface of central control panel.

1. Tap to select the seat to be adjusted.

### Tips

- After turning on the steering wheel to adjust the lumbar support on the central control panel, roll the rollers on both sides of the steering wheel to adjust the height and position of the lumbar support.

- The front passenger's seat does not have lumbar support adjustment.

2. Tap to enter the adjustment interface of the selected seat.
3. Tap to recall the memory position of the selected seat.

### Tips

- After turning on the lumbar support adjustment via steering wheel buttons in the CID, scroll the rollers on both sides of the steering wheel to adjust the height and position of the lumbar support.
- The passenger seat does not support cushion and lumbar support adjustment.

### caution

- Adjust the seat with caution and ensure that other occupants are not injured when the seat is moved.



- Do not put your fingers or other parts of your body under the seat, as this may cause the pinch injury.
- Do not place floor mats or other foreign objects (e.g., beverage bottles, charcoal bags, etc.) with a thickness of more than 10mm on the bottom of the front seats, as they may get caught between the seat and the guide rail, preventing the seat from being adjusted and locked, and thus damaging the seat. It is recommended to use the floor mats approved by XPENG.
- Do not adjust the front seats while driving, as this may lead to the incorrect sitting posture and cause accidents.
- Do not adjust the seat with the seat belt fastened to prevent the abnormal use of the seat belt, which may cause personal injury and protection failure.
- Do not modify or disassemble the front seats.

## Seat memory

In the “**Seat**” interface of the central control panel, you can adjust the seat position to an appropriate status and save it according to the prompts on the central control panel.

## Seat heating

### Introduction



Open the A/C interface, tap “**Seats and Steering Wheel**” to open the seat heating and ventilation interface.



Tap “☺” to activate the heating function of corresponding seat, with 3 levels. Repeatedly tap it in a cycle of Level 2, Level 1, Off and Level 3.

The driver's and front passenger's seat heating functions can be enabled/disabled through the shortcut panel interface of the central control panel or the bottom status bar (if set) [See 32 page](#).

### Seat ventilation

#### Introduction



Open the A/C interface, tap “**Seats and Steering Wheel**” to open the seat heating and ventilation interface.

Tap “☼” to activate the ventilating function of corresponding sea, with 3 levels. Repeatedly tap it in a cycle of Level 2, Level 1, Off and Level 3.

The driver's and front passenger's seat ventilation functions can be enabled/disabled through the shortcut panel interface of the central control panel or the bottom status bar (if set) [See 32 page](#).



## Steering wheel heating

### Introduction

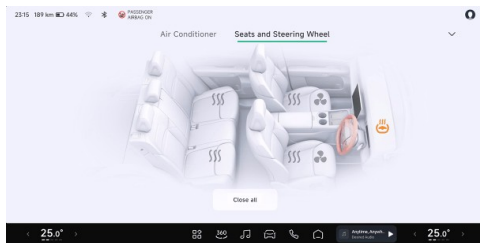

Open the A/C interface, tap **“Seats and Steering Wheel”** to open the steering wheel heating interface.

Tap “” to turn on the steering wheel heating function. The level is Level 3. Repeatedly tap it in the cycle of Level 2, Level 1, OFF and Level 3.

## Adjustment of windows

### Introduction

You can control the windows in the following four ways:

- Interior buttons
- X-Peng voice
- CID
- Mobile App bluetooth key

#### Tips

When the one-button closing and anti-pinch function fails, you can try the following initialization procedure [See 157 page](#).

#### warning

- Before closing the window, the driver must ensure that all passengers (especially children) have not put any part of their body out of the window, otherwise, pinch injury can occur!



- When locking the vehicle, the windows will be closed automatically, so the driver must make sure that the all passengers will not be pinched by the closing windows before locking the vehicle.
- Before leaving the vehicle, please make sure that the vehicle is powered off.

### Operation

#### Adjustable by driver window switch

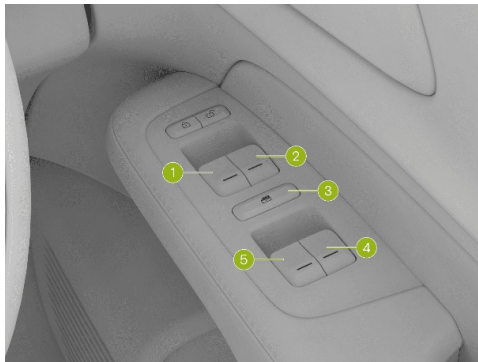

1. Front left window regulator switch
2. Front right window regulator switch
3. Locking switch of passenger door glass regulator
4. Rear right window regulator switch



### 5. Rear left window regulator switch

#### Adjustable by passenger window switch



The left front door, the left rear door and the right rear door are equipped with passenger window glass regulator switches.

Pull the window regulator switch up/down to the second gear, and the window will automatically move to the fully closed/open position.

Pull the window regulator switch up/down to the first gear and hold it at this position, and then the window starts to rise/fall. Release the switch, and then the window stops moving.

When the passenger window switch disabling function is turned on, the indicator on the switch illuminates. At this time, the window switches on other doors are disabled, and all windows can only be adjusted by the window switch on the driver's door.

#### **i** Tips

When there is a child in the vehicle, to ensure safety, the passenger window shall be locked to prevent the child from operating the window and avoid pinching.



### Adjustable by central control panel

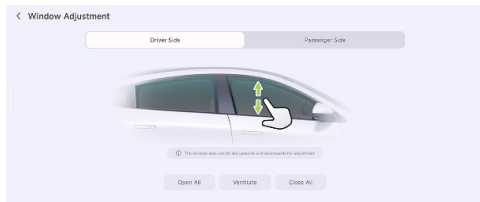

On the “→**Window&Door**→**Window Adjustment**” interface of the central control panel, you can set “**open All, Ventilate, Close All**”. You can also swipe up and down in the window area for adjustment.

### Automatic window closing

On the “→**Window&Door**” interface of the central control panel, you can open/close the “**Close windows automatically after vehicle locking**” and “**Close windows automatically when travelling at high speeds**”.

### Window anti-pinch

When the window is controlled to close, if it is blocked by an obstacle in the anti-pinch area, the window will stop closing and return for a certain distance.

#### **warning**

Even if the window is equipped with anti-pinch function, there is still a possibility of pinching when the window is closed. It is forbidden to activate the anti-pinch function by blocking the closing of the window with any part of your body.



## Steering wheel buttons

### Introduction

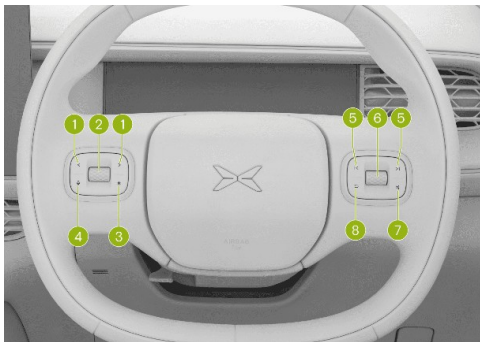

#### 1. Left and right buttons:

- Default: Adjust the A/C blower speed.
- With ACC activated, adjust the cruise distance.

- After activating the adjustment of exterior rearview mirror, control the left exterior rearview mirror to turn leftward or rightward.

#### 2. Upper and lower rollers:

- Roll up and down to adjust the A/C temperature.
- Tap and hold it to enter the card switching mode on the left screen of the instrument panel, scroll up and down to select cards, and tap to confirm selection.
- With ACC on, scroll up and down to increase or decrease the speed.
- After activating the adjustment of exterior rearview mirrors, roll up and down to turn over the left exterior rearview mirror.

#### 3. Steering wheel shortcut key:

Tap and hold this key to set the function of it, and tap it to execute the set function.

#### 4. Voice wake-up button:

Wake up or cancel X-Peng voice.

#### 5. Previous/next song button:



- Tap to play the previous or next radio station/chapter/song.
  - After activating the adjustment of exterior rearview mirror, control the right exterior rearview mirror to turn leftward or rightward.
6. Upper and lower rollers:
- Scroll up and down to adjust the media volume.
  - Tap the multimedia play/pause/pop-up window to confirm.
  - Tap and hold it to enter the card selection status on the right side of the instrument cluster.
  - When there is a phone call, scroll up/down to select Answer/Reject, and tap the scroll wheel to confirm. During the call, tap it to hang up.
  - After activating the adjustment of exterior rearview mirrors, roll up and down to turn over the right exterior rearview mirror.
7. Mute button: tap to mute/unmute.

8. Return key.

### Horn



Tap the horn mark area to sound the horn.

#### **caution**

Do not tap the horn mark area for a long time; otherwise, it is easy to damage the horn.



## warning

Do not press or hit the area with horn symbol vigorously to avoid triggering the deployment of the driver's airbag and causing personal injury.

## Key emergency function

Tap and hold the voice wake-up button and mute button at the same time to restart the instrument panel and central control panel.

This function can be temporarily used in cases such as abnormal display of the instrument panel or central control panel and sudden screen jamming. If the fault still exists after restart, please contact XPENG Service Center for maintenance in time.

## Steering wheel shortcut key



Tap and hold the steering wheel shortcut key or the “ → **Drive** → **Steering Wheel Shortcut**” interface on the central control panel to set the steering wheel shortcut key function.



### Cup holder

#### Introduction

##### Front cup holder

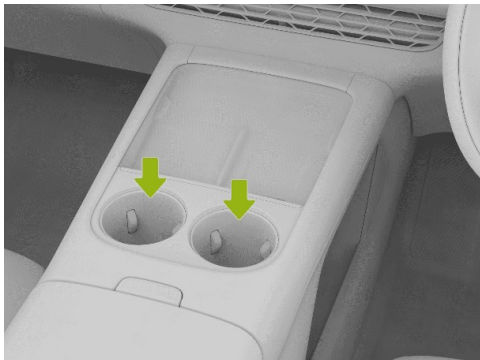

The dashboard is equipped with a cup holder, which can be used to place drinks and water cups.

##### Rear cup holder



After flipping down the central armrest of the rear seat, press the button on the front end of the armrest lightly to open the cup holder for use.

#### **warning**

- Do not place fine objects and other debris in the cup holder to avoid jamming.



- Do not place open beverage cups in the cup holder while driving. Otherwise, hot beverages spilled from the cups may burn the driver and occupants in the vehicle, and will also damage the vehicle and its electrical equipment.

### Power outlet and data interface

#### Introduction

#### Interior rearview mirror base interfaces



USB power port: Supply power to the external DVR.



### caution

- To avoid damaging the electrical system of the vehicle, do not connect the power generating equipment to the USB power port.
- When the vehicle is powered on or off, disconnect the charging equipment connected to the USB power port to avoid damage to the electric equipment caused by voltage fluctuation.
- Do not use the USB power port when no one is in the vehicle. Improper use of the USB power port may cause a fire.
- Do not use the high-power electrical equipment.

### Central armrest box front interfaces



1. USB media source interface: For microphone, gamepad, data transmission\* ( if applicable ) etc.
2. Type-C power port: For data transmission and charging of electronic devices, support standard charging protocol with a maximum power of 60W. Support USB2.0 data transmission, wired Carplay.

# Comfort driving



3. 12V socket: Maximum power of 180W.

## caution

Do not charge the equipment using the USB media source interface, as this may cause the CID to reboot or black out.

## Central armrest box rear interfaces



1. Type-C power port: Maximum power of 15W.

## warning

Do not modify the Type-C interface at will.

## Trunk internal interface

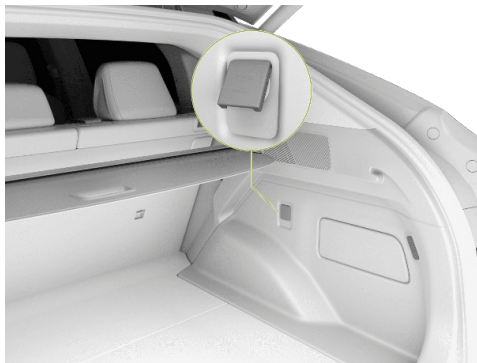

12V socket: Maximum power of 180W.

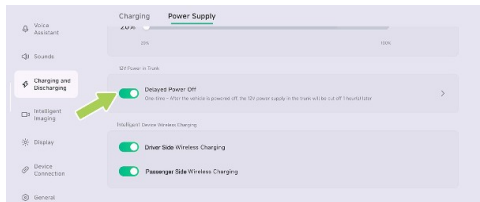

After “**Delayed Power Off**” is turned on in the “**🚗 → Charging and Discharging → Power Supply**” interface of the central control panel, you can set the delayed power-off time of the trunk 12V power supply after the vehicle is powered off.

## Cellphone wireless charger (CWC)

### Introduction

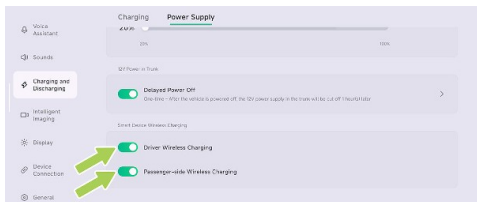

Driver-side Wireless Charging or Passenger-side Wireless Charging can be turned on/off in the “**🚗 → Charging and Discharging → Power Supply**” interface of central control panel.

#### **caution**

Some cellphones without wireless charging function placed on the wireless charging pad may cause the screen flashing, jumping, etc., if necessary, it is recommended to turn off the wireless charging via the CID.

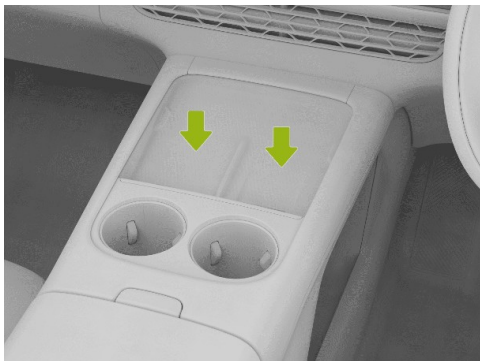

The wireless charging area is located at the front of the dashboard. When charging, please face up the phone screen and slide the phone to the bottom of the charging area along the limiting strip, which will facilitate the induction, charging and heat dissipation of the phone. The “” will be displayed on the CID while charging.

### Tips

The CWC function supports charging power up to 50W and can cool down the cellphone by air to enhance the charging efficiency.

Wireless charging will stop when:

1. The phone is placed at the top of the charging area, resulting in charging interrupted or not sensed.
2. The foreign object is detected between the phone and the wireless charging module during charging.
3. The vehicle key searching function is enabled.
4. The vehicle is not in Ready state and the brake is applied.
5. The vehicle is in Ready state, and the vehicle speed reaches 40km/h for the first time.
6. The vehicle is in Ready state and the last door is closed.
7. The right front door is unlocked, the four doors are closed, and the trunk is closed.



### warning

- The CWC function can heat the metal. Please ensure that there are no metal foreign objects on the back of the cellphone and the charging area before charging. Otherwise, the metal foreign objects may be heated or damaged, or even cause a safety accident. Metal foreign objects refer to objects with metal components, including but not limited to chips, magnetic cards, etc.
  - When a cellphone without wireless charging function is placed in the charging area, it is recommended to manually tap the CID settings to deactivate the wireless charging function, so as not to affect the normal use of the cellphone.
  - For a cellphone with 50W wireless fast charging function, the cellphone must be placed at the bottom of the charging area along the limiting strip, and the cellphone must completely cover the air outlet to avoid overheating.
- The air outlet of the wireless charging cooling fan is located at the lower end of the wireless charging. Please prevent the foreign objects and liquids from entering the air outlet and affect the operation of the fan.
  - Do not spill water in the wireless charging area to prevent water from entering the wireless charging module and causing damage to electronic components.
  - External wireless charging coils may cause accidents, so please use them with caution.
  - When the driver leaves the vehicle, please do not place the unattended cellphone in the vehicle for charging to avoid causing safety hazards.
  - Please do not place heavy objects in the charging area to avoid damaging the wireless charging module.
  - If the wireless charging function fails or works abnormally, please stop using it and contact the XPENG Service Center for maintenance.

## Comfort driving



- The cellphone will heat up after being charged for a long time, which is normal. Do not continue to place the charging device in the charging area after it is fully charged to avoid overheating.
- Do not use cellphone cases made of metal, such as those that support magnetic charging (MagSafe).

## Reading light

### Introduction

Reading lights are installed on the ceiling of the vehicle.

### Turning on/off front reading lights



The reading lights are installed in the headliner switch panel. Touch the corresponding side reading light shade to light up the reading light; Touch again to turn it off.

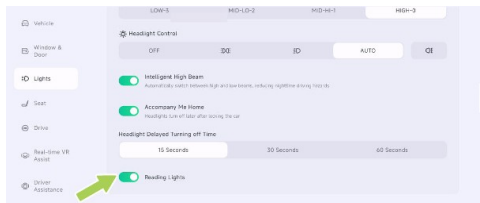

On the “→**Lights**” interface of the central control panel, you can turn on/off the reading light.

### **i** Tips

The reading lights can also be switched on/off by voice.

### Turning on/off rear reading lights



Press the corresponding side reading light switch to light up the reading light; Touch again to turn it off.



## Sun visor and vanity mirror

### Introduction

#### Sun visor

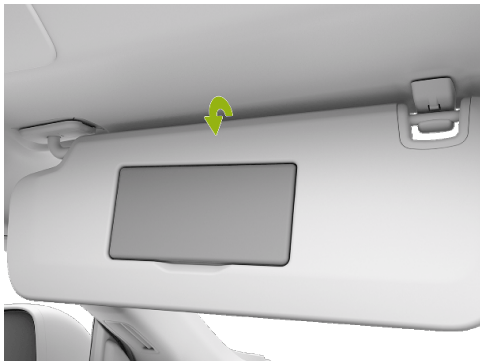

Flip down the sun visor as indicated by the arrow to block the sunlight coming through the front windshield.

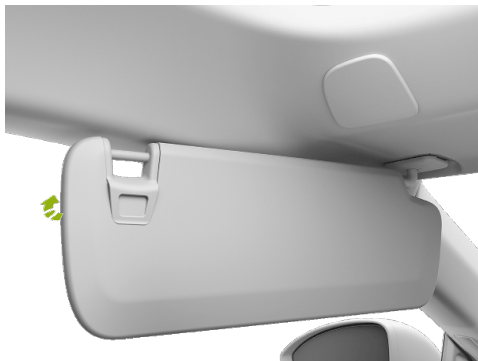

After flipping down the sun visor, remove the end of the sun visor near the interior rearview mirror from the bracket and flip the sun visor toward the window to block sunlight coming through the window glass.



### warning

The sun visor flipped down may obstruct the view ahead. If the sun visor is no longer needed, please restore it to its bracket.

### Vanity mirror



The vanity mirrors are embedded in the sun visors on both driver and passenger sides. Flip

down the sun visor and lift the vanity mirror cover up, the vanity mirror light will go on automatically; Close the vanity mirror cover, the vanity mirror light will go off automatically.

## Panoramic moonroof

### Introduction

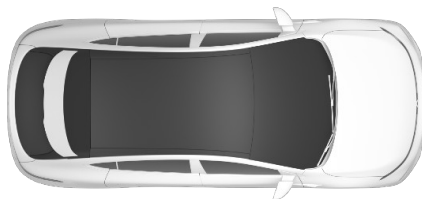

## Comfort driving



The vehicle is equipped with a panoramic moonroof, which provides you with a wider field of vision. The moonroof is provided with thermal insulation coating to enhance your driving experience.

### **caution**

After leaving the vehicle under the sun in hot weather, the temperature of the panoramic moonroof will be high, please do not touch it at this time, otherwise, burn injury may occur.

## Trunk shade

### Operation

The trunk is equipped with a shade.

### Use of shade



1. Pull out the shade.
2. Snap the two ends of the shade into the fixing grooves on both sides of the trunk.

### **warning**

It is prohibited to place any objects on the unfolded shade, otherwise the shade will be



damaged or the objects will be thrown forward and cause personal injury in the event of a collision.

### Removal and installation of shade

- Retract any end of the shade to remove it.
- When installing, first snap one end of the shade into the fixing groove, then retract the other end of the shade and snap it into the fixing groove.

## Audio on driver side

### Introduction

The driver's audio mode can be set on the “🚗 → **Sounds** → **Driver's Speaker**” interface of the central control panel.

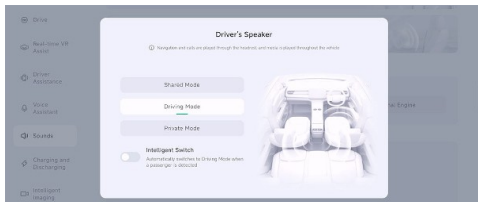

The audio has three modes on the driver side:

- **Shared Mode:** All sounds are played through audio in the vehicle.
- **Driving Mode:** Navigation and calls are played by audio inside the driver seat backrest, without affecting the music experience.
- **Private Mode:** All sounds are played by audio inside the driver seat backrest, only the driver can wake up voice assistant.

Tap “**Intelligent Switch**” to automatically switch to Shared Mode when the front passenger seat is occupied.



## External discharge V2L

### Introduction

This vehicle can use the discharge device to supply the power of traction battery power to other electrical appliances with the discharge voltage of 230V and the maximum power of 3.3kw.

### Operation

1. Open the charging port.
2. When the conditions are met (vehicle unlocking & battery power exceeding the power supply limit), insert the power plug to directly start supplying power outward.
3. When power supply is completed, tap “**End Power Supply**”.
4. Press and hold the unlock button of the charging plug to remove the charging plug.

### Caution and limitation

#### Tips

- The power supply will stop automatically after the SOC limit (if set) of the traction battery is reached.
- When the SOC of the traction battery is lower than 20%, the external discharge function is not available.

#### warning

- Do not use the external discharge function when the external electric appliance or charging plug is damaged.
- Never allow minors to touch or use the charging plug, and keep them away from the charging plug during use.
- When the power supply is abnormal, please deactivate the external discharge function immediately.



- Do not touch the plug pins of electrical appliances and the socket of the charging plug.
- Do not use shoddy products, medical or health care electronic devices.
- Do not use products that require a continuous power supply, such as medical equipment. The power supply may be interrupted depending on the vehicle's condition.
- Put the power plug fully and use the qualified plug that meets the standard. If you use worn, corroded or broken plug or improper plug, it might be a cause of malfunction.
- Do not use high power home appliances that pull current for a long time such as air conditioning, washing machine or dryer, etc.
- Do not hang the home appliances on the adapter.
- For devices used outdoors in a vehicle, use a product with a waterproof function or use

it in a waterproof environment. Do not use in environments with rain or high humidity. (Electrical appliances, multi-outlets, cord extension cables, etc.)

- If there is a risk of lightning, do not use the V2L function outside the vehicle.
- Do not connect multiple portable multi-outlets.
- When using an extension cable, if the cable is twisted or overlapped by itself may cause a fire. Be sure to use the cable without twisting it.



## Vehicle loading

### Introduction

#### Central armrest box

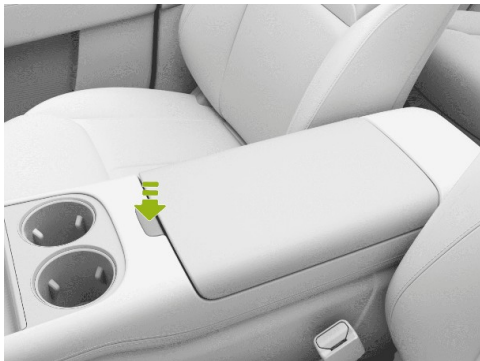

The dashboard is equipped with a central armrest box, which can be opened for use by pressing the switch.

#### Door storage box

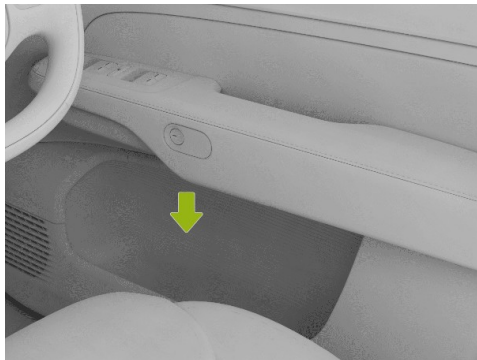

The doors are equipped with storage boxes on the lower part for holding drinks or other items.



### Map pocket



The front seats are equipped with the map pockets on the lower part for storing tickets, magazines and other items.

### Card holder



The sun visor is equipped with a card holder for holding business cards and other cards.



## Towing mode\*

### Description

Your vehicle is equipped with the towing caravan function, and the towing mode can be enabled on the CID. The driver shall possess appropriate qualifications and licenses to tow a caravan.

Before you decide to tow a caravan, you should first check the relevant local regulations on motor vehicles. As the regulations in different regions are different, you need to select a caravan of the appropriate size and consult your local service provider before towing.

#### **caution**

- When towing a caravan, please comply with the relevant local laws and regulations, and never modify the vehicle at will.
- Please do not tow the caravan during the running in period of the new car.
- Please restore the towing device when not towing a caravan.

- It is not permitted to tow a caravan equipped with electric service brake.

### Instrument panel indicators



The trailer wiring harness is normal, and the suspension/ESP/towing hook is normal.



Th trailer wiring harness is normal, the suspension/ESP/towing hook may have a fault, and the towing mode fails.



The towing mode cannot be used due to a trailer wiring harness fault, trailer signal light fault or suspension/ESP/towing hook fault.



## Function on/off

### On

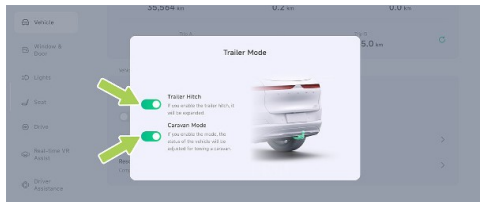

When the vehicle is in P gear, the trailer hitch and caravan mode can be turned on/off on the “→**Vehicle**→**Trailer Mode**” interface of the central control panel.

### **caution**

- A second confirmation is required and the vehicle must be engaged in P gear when using the towing hook and entering towing mode.
- The CID switch will be invalid during the operation of the towing hook and will be

valid when the towing hook is fully extended or retracted.

- When using the towing hook, none of the driving assist functions except AEB and FCW can be activated. When the towing hook is completely retracted, the related driving assist functions return to the state before the towing hook is used.

The towing mode cannot be activated when:

- The vehicle is not engaged in P gear.
- The towing hook is not extended.
- The suspension and ESP functions are abnormal.
- The suspension is in service mode or suspension leveling mode.
- The sensor is in locking mode during aftermarket calibration.
- The lift mode or marine mode is turned on.



## caution

When towing a vehicle, the towing mode must be turned on, otherwise the vehicle will be damaged.

## Off

After the caravan is disconnected from the towing hook and the electrical connector is disconnected, tap Towing Hook ON/OFF on the CID to exit the towing mode and retract the hook simultaneously.

## Electrical connector

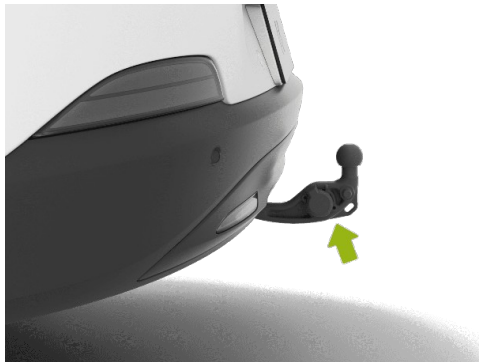

The electrical connector is installed on the towing hook. After the towing hook switch on the CID is turned on, the connector will be extended out together with the towing hook. It can be used after the protective cover is opened.



### caution

Please do not use a high pressure washer to clean the electrical connector not connected to the caravan interface directly, owing that water ingress may result in damage of the connector.

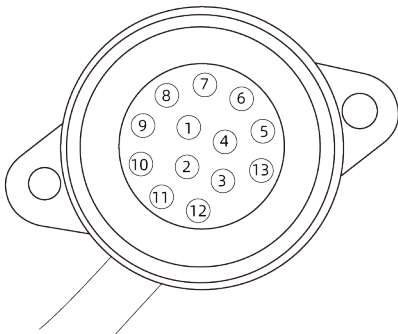

The electric connector equipped for this vehicle is a 13-core coil, and the standard applicable to

the power outlet is ISO 11446:2004. The specific pin functions are as follows:

Pin No.	Color	Function
1	Yellow line	Left turn signal light
2	Blue line	Rear fog light or reversing light
3	White line	1-8-pin bus ground wire
4	Green line	Right turn signal light
5	Brown line	Right running light
6	Red line	Brake light
7	Black line	Left driving light (integrated with 5)
8	Pink line	Reversing light



9	Orange line	To battery
10	Grey line	Battery or refrigerator
11	Black and white line	10-pin grounding line
12	Blue and white line	Spare wire
13	Red and white line	9-pin grounding line

### Rearview mirrors and brackets

The exterior rearview mirrors of the towing vehicle shall meet the legal requirements. If not, please install suitable mirrors for the towing vehicle.

Type I

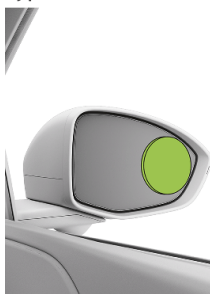

Type II

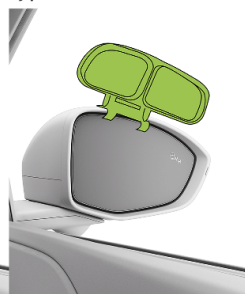

#### Type I

Pasted on the surface of exterior rearview mirror;

#### Type II

Held by a bracket that is mounted on the frame.

### Technical parameters

The towing capacity of the vehicle will depend on the vehicle specifications, load, road conditions and the trailer specifications, etc. To



## Comfort driving

ensure driving safety, please do not overspeed or overload. Please refer to the table below for specific parameters.

Item	Data
Maximum allowable towing mass (with braking) <b>[kg]</b>	1500
Maximum allowable towing mass (without braking) <b>[kg]</b>	750
Maximum tongue load <b>[kg]</b>	75
Maximum dimension of passenger car and trailer combination (L*W*H) <b>[mm]</b>	14500*2550*4000
Dimension limit of center axle trailers	12000*2550*4000

that can be towed (L*W*H) <b>[mm]</b>	
Maximum dimension limit for the rear suspension of the trailer <b>[mm]</b>	3500
Electrical connector	13-pin standard interface in compliance with ISO11446:2004
Ball joint	Comply with ECE R55 A CLASS for ball joint size.



## Maximum allowable towing mass

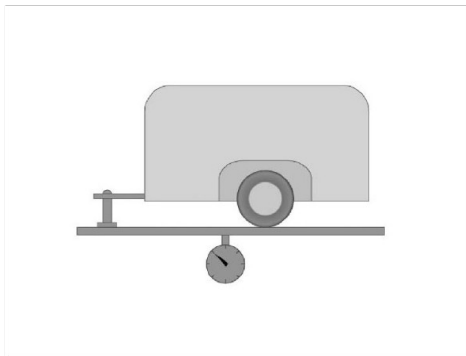

Traction weight is the total weight of the trailer and its cargo.

## Maximum tongue load

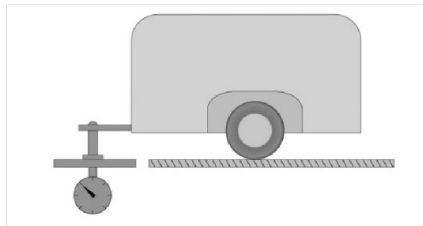

The maximum tongue weight is the maximum vertical load the towing hook can handle at the joints with the trailer.

## Power limit of trailer taillight

The power of trailer taillight shall not exceed the following specified values:



- Left/right position light: 24W.
- Left/right turning light: 24W.
- Rear fog light: 42W.
- Reversing light: 42W.
- Brake light: 42W.

### Precautions for driving

#### Start driving

Please ensure the tire pressure, lights and connection devices of the towing vehicle and trailer are normal prior to driving. After the trailer is connected, turn on “**Towing Mode**” on the CID.

Please load the trailer cargo securely and ensure that the cargo is properly fastened. The trailer shall be kept level, otherwise do not drive the vehicle.

Star the vehicle steadily and avoid sudden acceleration and emergency braking, especially when driving on wet and slippery roads, as it may cause the vehicle to skid and lose control.

Crosswinds and rough roads may cause the vehicle to swing, seriously affecting the handling of the vehicle. If you notice slight signs of the vehicle swinging in any case, be sure to hold the steering wheel with both hands and slow down immediately. Do not attempt to eliminate swinging by increasing the speed.

Try to avoid towing a loaded trailer while the towing vehicle is empty. If not possible, drive slowly due to unreasonable load distribution.

#### Braking

Towing a trailer will increase the braking distance of the vehicle. Therefore, the distance from the vehicle ahead should be increased.

#### Overtaking

With a trailer towed, the length of the vehicle body plus the trailer will become longer. Therefore, it needs a longer distance for overtaking before the vehicle returns to the original lane.



## Reversing

Reversing with a trailer is different from regular reversing and can be more challenging. Therefore, you should be especially cautious and practice it more.

Hold the bottom of the steering wheel by one hand when reversing. To steer the trailer to the left, turn the steering wheel to the left; To steer it to the right, turn the steering wheel to the right. Always reverse at a low speed and ask for help from others if possible.

## Turning

When towing a trailer, make sure to turn smoothly, try to avoid bumping or sudden operation, and switch on the turn signal light earlier. The turning radius must be wider than when no trailer is being towed. This will prevent the trailer from hitting road shoulders, road signs, trees or other objects.

## Driving on slopes

Slow down earlier before towing a vehicle to a steep or long slope. The driving speed is determined by the trailer weight and the steepness of the slopes.

Try to avoid parking on a slope. If unavoidable, the wedge blocks should be set up under the tires of the towing vehicle and the trailer, and the parking brake should be applied.



### Power on/off

#### Introduction

##### Vehicle power-on

When the vehicle is unlocked and any door (excluding the tailgate) is opened, the vehicle will be automatically powered on.

When the vehicle is powered off, if the I-key or cellphone App Bluetooth key is placed inside the vehicle and the brake pedal is pressed, the vehicle will be automatically powered on.

##### Vehicle power-off

##### Normal power-off

With the vehicle powered on or in the “**READY**” state, if the driver seat is not occupied and all doors (including the front hood and trunk lid) are closed, the vehicle will be powered off once the any of the following operations is performed:

- Locking the vehicle via the I-key.
- Locking the vehicle via the cellphone App.

##### Emergency power-off

For specific operations, refer to [See 288 page](#).

##### Automatic power-off

When the driver seat is unoccupied, the vehicle is parked and all the doors, front hood and trunk lid are closed, the vehicle will be powered off automatically after 1-hour countdown without any operation.

In the last 10min of countdown for automatic power-off, a pop-up window will be displayed on the CID. You can tap to cancel and restart the 1-hour countdown.



### Automatic anti-glare of interior rearview mirror

#### Introduction



1. Front light sensor
2. Rear light sensor

This vehicle is equipped with automatic anti-glare interior rearview mirror. The light sensor on

the mirror body can detect the intensity of light coming from the rear and front of the vehicle. According to the measured data, the interior rearview mirror will automatically adjust the anti-glare state.

#### **i** Tips

Do not cover the light sensor on the interior rearview mirror, and clean the surface of the light sensor timely.

### Adjustment of exterior rearview mirror

#### Introduction

The exterior rearview mirror can be adjusted in the following ways:

- Adjusting the lens angle by steering wheel buttons.

The exterior rearview mirror adjustment can be waken up in the following ways:

- X-Peng voice



- Shortcut panel of central control panel [See 32 page](#)
- Bottom status bar of central control panel (if set) [See 31 page](#)
- Tap “☰ → **Drive** → **Side Mirrors**” in turn on the central control panel.
- Lens position memory
- Auto flipping-down while reversing
- Auto folding/unfolding of exterior rearview mirror
- Manual folding/unfolding of exterior rearview mirror

### Operation

#### Adjusting the lens angle by steering wheel buttons

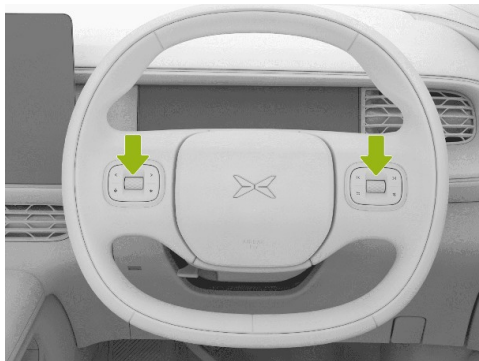

After the exterior rearview mirror adjustment is woke up, the exterior rearview mirror lens angle [See 220 page](#) can be adjusted through the rollers on both sides and the left and right buttons of the steering wheel.



## caution

When the exterior rearview mirror is adjusted to the limit position, its lens will move up and down to give a prompt, which is normal. If you continue to adjust the exterior rearview mirror in this direction, it may be damaged.

## warning

- Do not adjust the exterior rearview mirrors while driving to prevent accidents.
- Do not press the rearview mirror lens manually to adjust its tilt angle.
- Do not modify the exterior rearview mirrors at will.

## Lens position memory

After adjusting the exterior rearview mirror lens angle, it will be automatically saved to the current driving habits.

## Auto flipping-down while reversing



After the exterior rearview mirror adjustment is woke up, the **“Tilt down the left/right side mirror when reversing”** can be turned on. When the vehicle is shifted into R gear, the corresponding side (with Auto-Tilt function activated) exterior rearview mirror lens will automatically tilt down to a certain angle to assist reversing.

## Auto folding/unfolding of exterior rearview mirror

When the Fold Side Mirrors is turned on automatically after vehicle locking:



- Unfold: When the vehicle is unlocked, the exterior rearview mirrors will automatically unfold.
- Fold: When the vehicle is locked, the exterior rearview mirrors will automatically fold.

### Manual folding/unfolding of exterior rearview mirror

After waking up the exterior rearview mirror adjustment, tap the “**Unfold**”/“**Fold**” button to manually unfold or fold the exterior rearview mirrors.

### Resetting of exterior rearview mirror

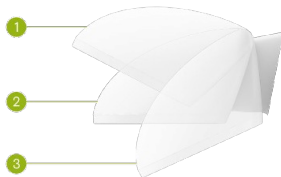

1. Forward folding state
2. Standard state
3. Rearward folding state

The exterior rearview mirrors may be in a forward or rearward folding position due to accidental impact or manual pushing, but they can be restored to normal positions as follows.



1. Tap “**Unfold**” and wait for the exterior rearview mirrors to complete the adjustment.
2. Manually push the exterior rearview mirrors to the normal position.

## **i** Tips

Before manual reset, check whether there are foreign objects such as ice and snow on the folding surface, and reset only after removing the foreign objects, otherwise it is easy to damage the folding mechanism of the exterior rearview mirror.

## **!** warning

When unfolding or folding the exterior rearview mirror, be sure that your fingers are not caught between the exterior rearview mirror and the exterior rearview mirror base.

## Adjustment of steering wheel

### Introduction

#### Adjustment of steering wheel position



1. Press the steering wheel handle downward to unlock the steering wheel.
2. Move the steering wheel up/down and in/out to the proper position.



3. Pull the steering wheel handle upward to lock the steering wheel.

## Steering assist

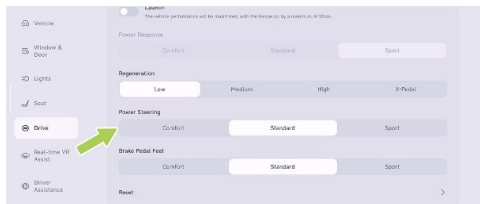

On the central control panel “**Drive**” interface, select “**Comfort, Standard or Sport**” in “**Power Steering**”.

- **Comfort:** Light steering effort, recommended for comfort driving mode.
- **Standard:** Moderate steering effort, recommended for standard driving mode.
- **Sport:** Heavy steering effort, recommended for sport driving mode.

## warning

- It is prohibited to adjust the steering wheel or set the PAS mode while driving.
- Improper adjustment of the steering wheel position may cause personal injury. The steering wheel should be at least 25 cm away from the chest of the driver .

## Adjustment of exterior lights

### Introduction

### Controlled by central control panel

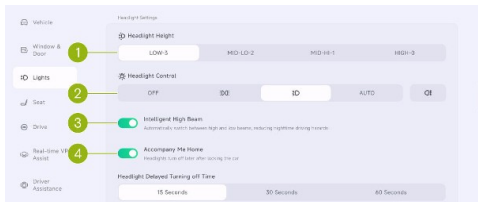

1. Headlight Height:



- The headlight height can be set to suit vehicle driving and load adjustment according to the situation.

## 2. Headlight Control:

- Off: Tap it to turn off all exterior lights.
- : Tap to turn on/off the clearance light and license plate light.
- : Tap it to turn on/off the low beam.
- Automatic: The low beam is turned on/off automatically according to the ambient brightness of the vehicle.
- : Tap this button to turn on/off the rear fog lights. If the low beams do not illuminate, they will be turned on simultaneously.

3. Intelligent High Beam: Tap this button to turn on/off the intelligent high beam.

## 4. Accompany Me Home:

- After it is turned on, when the ambient brightness around the vehicle is low, "Accompany Me Home" function will be

activated. The headlight can be set to go out after a delay of "15 Seconds", "30 Seconds", "60 Seconds".

## Headlight height adjustment

The headlight height suitable for vehicle driving and load adjustment can be set according to the situation, with reference as follows.

Condition	Headlight height position
Driver only	HIGH-O
Driver and one front passenger only	
There are five persons in the front and rear seats	MID-HI-1



Five persons on front and rear seats, with luggage in the trunk (within maximum permissible axle load and maximum permissible vehicle weight limits)	MID-LOW-2
Driver only, with luggage in the trunk (within the limits of maximum permissible axle load and maximum permissible vehicle weight)	LOW-3

### Turning on/off daytime running lights

**On:** When the vehicle is in READY state, the gear is in non-P position, and the low beams and turn signal lights are off, the daytime running lights will go on.

**Off:** When the vehicle is powered off or not in READY state, the gear is in P position, and the low beams and turn signal lights are on, the daytime running lights will go off.

### Turning on/off high beams



- When the low beams are on, move the combination switch forward once to turn on the high beams, move the combination switch forward again to turn off the high beams.
- Move the combination switch backward continuously and release it, the high beams will flash to remind the vehicle ahead.



## ⚠ caution

The drivers of oncoming vehicles will be dazzled by high beam, so please use it reasonably.

## Turning on/off the turn signal lights



When the turn signal lights are turned on, the corresponding indicator on the ICM flashes with “tick” sound.

- Move the combination switch downward to the limit to turn on the left turn signal light and the ← indicator on the instrument panel flashes.
- Move the combination switch upward to the limit to turn on the right turn signal light and the → indicator on the instrument panel flashes.
- Move the combination switch to the left/right lane change switch position or center the steering wheel to turn off the turn signal lights.

## Turn signal light flashing

To indicate a lane change, move the combination switch upward or downward to the resistance point and release it, the combination switch will immediately return to its original position and the corresponding side turn signal light will flash 3 times.



### Wiper operation

#### Introduction



#### 1. Washer switch

- Press and release: Wipe once.
- Press and hold: The front washer sprays water and the front wiper wipes.

#### 2. Front wiper switch

- OFF: Stop wiping.
- AUTO: Wipe according to the rainfall.

#### Tips

Tap “ → **Window & Door**” on the CID to set the automatic wiper sensitivity

- LO: Low-speed wiping.
- HI: High-speed wiping.

#### 3. Rear wiper switch

- Move up: The rear wiper wipes/the rear wiper stops wiping.
- Move down and release: The rear wiper wipes once.
- Move down and hold: The rear washer sprays water and the rear wiper wipes.

#### caution

When using the rear wiper, the rear wiper will continue to wipe 3 times after releasing the switch and continue to wipe once after 10s.



## Shift operation

### Introduction

Depress the brake pedal, move the shift lever up or down, and the corresponding gear indicator will be illuminated, indicating a successful gear shift.

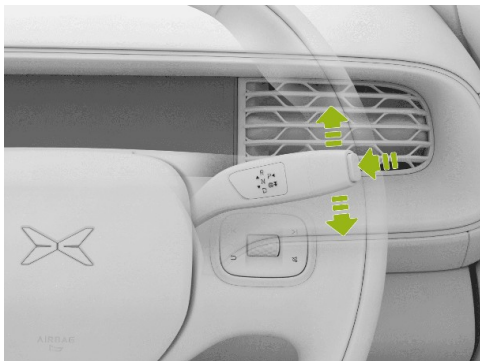

### R: Reverse gear

Depress the brake pedal when the vehicle is stationary and push the shift lever up by 2 gears. Then R on the gear display area of the instrument panel will be highlighted to indicate that the vehicle is shifted into R gear.

### N: Neutral gear

The vehicle can be shifted into N gear with the following operations, and the N on the gear display area of the instrument panel will be highlighted:

- When the vehicle is at D gear, push the shift lever up by one gear for 1s.
- When the vehicle is at R gear, push the shift lever down by one gear for 1s.
- When the vehicle is at P gear, depress the brake pedal and push the shift lever up or down by one gear for 1s.



### D: Drive gear

Depress the brake pedal when the vehicle is stationary and push the shift lever down by 2 gears. Then D on the gear display area of the instrument panel will be highlighted to indicate that the vehicle is shifted into D gear.

### P: Park gear

Depress the brake pedal when the vehicle is stationary and press the P button on the shift lever. Then P on the gear display area of the instrument panel will be highlighted to indicate that the vehicle is shifted into P gear.

#### Tips

With D or R gear engaged, the vehicle will automatically shift to P gear when the vehicle speed is below 3km/h, the seat belt is unfastened, the brake pedal or accelerator pedal is not depressed, and the driver side door is opened.

#### caution

- The gear can be shifted after certain conditions are met. If not, when you shift a gear, the instrument panel will display the text messages such as **“The charging plug is connected. Fail to shift gear”**, **“Please depress the brake pedal before gear shifting”**, **“Please slow down before gear shifting”**. Follow the instructions to ensure that the conditions are met.
- Before leaving the vehicle or parking on the slope, please make sure that the vehicle is engaged into P gear to prevent the vehicle from accidental movement.
- If you are unable to shift gears normally, you should contact XPENG Service Center for maintenance in time.



## Driving mode

### Introduction

In the “🚗 → Drive” interface of the central control panel, you can select the driving mode according to your personal preference.

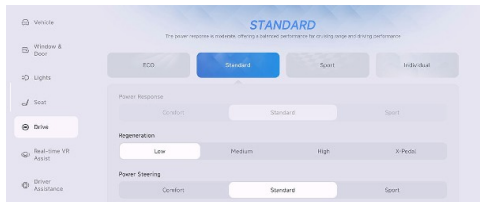

- ECO : The power response is slow, extending the vehicle range.
- STANDARD: The power response is moderate, offering a balanced performance for cruising range and driving performance.
- SPORT: The power response is swift, offering great driving pleasure.

- Launch control: The power response is radical, enabling ultimate acceleration capability.
- Individual: The user can adjust multiple parameters for personalized driving pleasure.

#### i Tips

- The “Launch” switch is only displayed in “Sport” mode.
- Launch mode is only enabled during the current ignition cycle and will be disabled when it is turned off manually or the vehicle is powered on again.



## Adjustment of brake pedal feedback

### Introduction

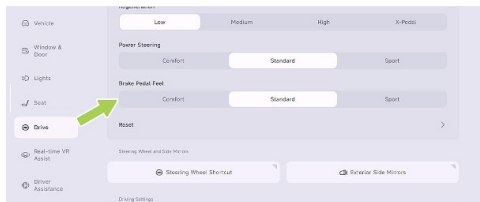

Tap “ → **Drive**” on the CID to adjust the brake pedal feedback according to personal preferences.

## Electronic parking brake (EPB)

### Introduction

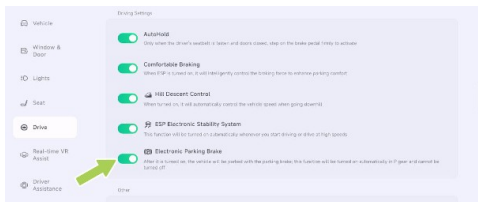

Tap “ → **Drive**” on the CID to turn on or off the EPB.

- On: Turn on the “**EPB**” button or press the P button when the vehicle is stationary. At this time, the indicator on the instrument panel is illuminated, indicating that the EPB has been enabled.
- Off: Depress the brake pedal, turn off the “**EPB**” button or switch to the drive gear (D or R) when the vehicle is stationary. At this time, the indicator on the instrument panel is go



out, indicating that the EPB has been disabled. When the vehicle is at P gear, it is unable to disable EPB by turning off “EPB” button.

## i Tips

- When the EPB is turned on or off, the system will emit a running noise, which is normal.
- With EPB on, if the vehicle cannot be powered on due to battery depletion, EPB can be turned off by jump starting or by contacting the XPENG Service Center.
- Under special circumstances, EPB can be turned on by pressing and holding the P gear button.

## ! caution

- If the EPB can not be activated or deactivated, contact XPENG Service Center for maintenance in time.
- Do not drive the vehicle without turning off the EPB, otherwise, the EPB can be damaged.

## AutoHold

### Introduction

If you need to stop for a while, turn on AutoHold and release the brake pedal, the system will automatically apply the brake and keep the vehicle stationary.

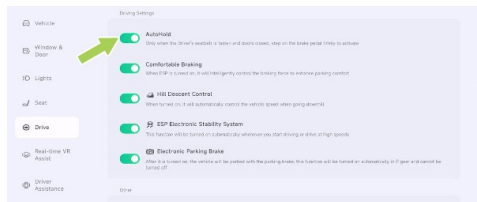

Tap “ → Drive” on the CID to turn on or off AutoHold.

### Function activation

- Activation: Depress the brake pedal hardly after the vehicle stops. When the indicator on the instrument panel is illuminated, it



indicates that AutoHold has been enabled. At this time, release the brake pedal.

- Deactivation: Depress the accelerator pedal to exit the AutoHold.

### **i** Tips

- AutoHold can only be activated when the driver side door is closed, the seat belt is fastened, and the gear is in D, R or N position.
- With AutoHold on, opening the driver side door or unbuckling the seat belt will automatically switch to EPB.
- AutoHold will switch to EPB after it has worked for a certain period of time.

### **!** warning

AutoHold can not go beyond the law of kinematics, so please turn on AutoHold according to the road conditions.

## Acoustic vehicle alerting system (AVAS)

### Introduction

When the vehicle is driving at a speed of less than < 30km/h, the vehicle will make an analog sound to alert the pedestrians and vehicles around.

### Operation

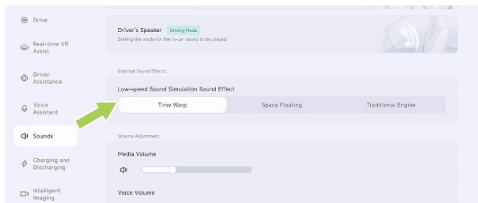

In the “🚗 → Sounds” interface of the central control panel, you can set Low-speed Sound Simulation Sound Effect.



## Energy recovery

### Introduction

When the vehicle is coasting or braking, the energy recovery function can convert part of the vehicle's kinetic energy into electric energy to charge the traction battery and extend the range.

### Operation

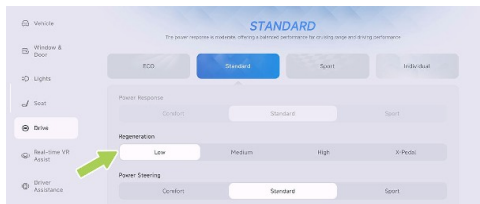

Tap “ → Drive” on the CID to set the energy recovery level.

### Factors affecting energy recovery

The electric quantity supplied through energy recovery to the traction battery is determined by the following factors:

1. Current state of the traction battery.
  - SOC of the traction battery.
  - Temperature of the traction battery.
2. Selected energy recovery level.

### Caution and limitation

#### Tips

- Different energy recovery levels result in various driving experiences.
- If regenerative braking significantly reduces the vehicle speed (e.g. when driving on a steep hill), the brake lights will go on to alert the driver of the vehicles behind that you are slowing down.



### warning

- The regenerative braking is not sufficient for safe driving, and the driver should apply the brakes in a timely manner according to the actual situation.
- X-Pedal (one-pedal mode) can reduce the use of the brake pedal when it is turned on, further recovering kinetic energy and improving range, but it cannot completely replace the brake pedal. To prevent slipping on slopes, it is necessary to depress the brake pedal to stop the vehicle when it is about to stopping, and depress the brake pedal hardly to activate AutoHold if necessary.

## Braking operation

### Introduction

#### Wading

After wading through water, slowly depress the brake pedal to dry the water and restore braking

performance. Try not to brake suddenly except in emergencies.

#### Aggressive driving

Under high-speed, continuous and emergency braking conditions, the temperature of the brake disc will rise rapidly and the braking performance will degrade. For safe braking, when the brake pads are severely worn and the temperature is very high, the integrated power brake (IPB) will be degraded, multiple MILs will be illuminated on the instrument panel, a “tick” sound will be heard from the front compartment and the pedal will kick back after brake application. In this case, reduce the vehicle speed and brake applications, and then perform a recovery operation after the brake disc and brake pad have cooled down.

The recovery steps are as follows:

1. Power off and lock the vehicle and wait for at least 5min. During this period, the driver seat shall not be occupied, and no operations shall be performed on the vehicle (such as depressing the brake pedal, opening doors),



- to allow the vehicle to enter in sleep mode completely;
2. Unlock and power on the vehicle, and wait at least 15s before opening the door and getting in;
  3. Depress the brake pedal to the floor (lean against the seat backrest to depress the pedal as hard as you can) for at least 20s.

**⚠ caution**

G6 braking system is not designed for the race. If you want to drive intensely or improve lap times on the track, you should replace the high-temperature resistant brake pads and cool the brake discs properly.



### Opening and closing of charging port cover

#### Introduction

The charging port cover can be closed in the following ways:

- X-Peng voice
- Charging port cover switch
- Cellphone App
- I-key [See 154 page](#)
- Center information display (CID)
  - 3D vehicle control [See 51 page](#)
  - Shortcut panel [See 32 page](#)
  - Bottom status bar (if set) [See 31 page](#)
  - “☞ → **Window & Door**” Interface
- Automatic closing

#### Operation

##### Charging port cover switch

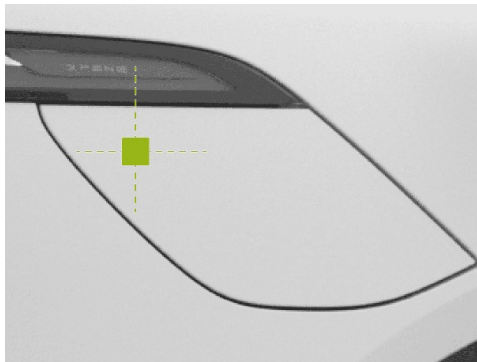

When the vehicle is unlocked or the cellphone App Bluetooth key (walk-in unlocking on) is carried, press the upper left area of the charging port cover to open the charging port cover.

# Charging instructions



## caution

When washing the vehicle, avoid using a high pressure washer to spray water on the charging port cover opening/closing area, as this may cause the charging port cover to open.



Press the switch to close the charging port cover.

## Tips

After charging, place the dust cover back into the charging port to prevent foreign objects from entering.

### Automatic closing of charging port cover

The charging port cover will close automatically if any of the following conditions is met:

- The vehicle is locked after the charging plug is removed.
- There is no operation after the charging plug is removed.
- When the vehicle is engaged in a non P gear.

## Charging operation

### Introduction

Charge the vehicle by a charging pile that meets the relevant standards.



### Operation

1. Opening of charging port cover [See 235 page](#).
2. Open the dust cover.
3. Insert the charging plug vertically into the charging port.

#### **caution**

- Do not connect the charging plug slantly.
- Make sure to connect the charging plug vertically into place.

4. Finish the payment and start charging.

#### **Tips**

Charging status can be viewed through the instrument panel, energy center interface on the CID, and cellphone App.

5. When charging is finished, tap End Charging in the energy Center interface of the CID and remove the charging plug.

#### **caution**

- During the slow charging, if the charging plug cannot be removed after unlocking, please push the charging plug tightly into place again and repeat the above unlocking operations before removing it again. Do not operate violently to avoid damaging the charging device and the vehicle.
  - After charging, if the charging plug cannot be removed, try to use the emergency release ring to unlock it [See 284 page](#).
  - Use the emergency release ring only after charging is completed.
6. Fit the dust cover and close the charging port cover.

#### **caution**

If the dust cover is not fitted but the charging port cover is closed, please open the charging port cover in time and fit the



dust cover to prevent water from entering the charging port or damaging the charging port cover and dust cover.

## Warning, caution and limitation

- When removing the charging plug from the charging pile, please hold the charging plug firmly with both hands to prevent the twisted charging cable from bouncing back and resulting in hitting injury.
- Before charging, please check whether the charging port, charging plug, charging socket and other equipments are dry. Do not perform the charging operation when charging equipments or hands are wet.
- Straighten the charging cable without twist for charging.
- Do not charge the vehicle when the charging equipment is corroded or damaged, such as charging plug metal terminal deformation, skew, socket plastic deformation, breakage and other abnormalities.
- In case of an emergency during charging, press the emergency stop button on the charging device to stop charging.
- It is recommended to stop charging the vehicle in thunderstorms, because lightning may cause damage to the charging device.
- Please select a shady or covered charging pile for charging to prevent rain and snow splashing at the time of connecting and disconnecting the charging plug.
- Unlock the vehicle before inserting/removing the charging plug. Always insert/remove the charging plug upright without any skewing or shaking.
- During charging, if strong pungent odor emits from the charging port, stop charging immediately.
- Never allow minors to touch or use the charging device.
- If there are foreign objects such as dust or large hard particles in the metal port of the charging stand, charging plug or charging



## Charging instructions

socket, clean it after powering off the vehicle before charging.

- If you have implanted electronic medical equipment such as cardiac pacemaker, cardiovascular defibrillator, in vivo PCEA, insulin pump or hearing-aid, please do not stay in the vehicle while charging, otherwise the function of the electronic medical equipment may be affected, resulting in personal injury or death.
- Do not disassemble or modify the charging port or charging cable.
- Close the charging port cover in time at the end of charging to prevent the ingress of rain, snow or other foreign objects.
- Considering the differences in understanding of the charging standards by charging pile manufacturers of various brands and the maintenance disadvantages of different charging pile products, there is a possibility that certain charging pile may not be used for charging. In this condition, please try to

re-connect the charging plug or change to another charging pile for charging.

### Slow charging schedule

#### Introduction

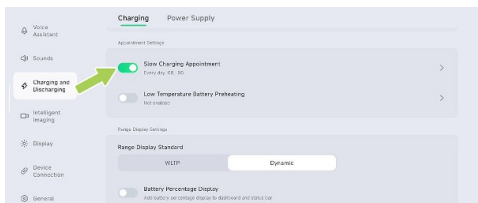

The vehicle can start charging at the specified time on the “ → **Charging and Discharging** → **Charging**” interface of the central control panel, and automatically stop charging after being fully charged (or reaching the limit).

#### Tips

Please make sure that the charging pile schedule function has been deactivated on

# Charging instructions



the cellphone App before turning on the slow charging schedule function, otherwise, this function will not be activated.

## **caution**

To use the slow charging schedule function, connect the charging plug and lock it to prevent the charging plug from being removed.

## Charging SOC limit

### Introduction

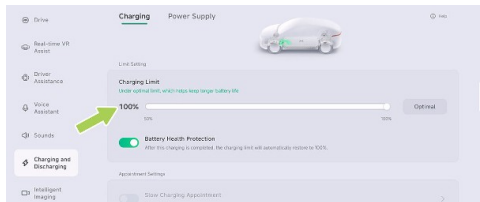

The charging limit can be set on the “ → **Charging and Discharging** → **Charging**” interface

of the central control panel, and the charging will automatically end when the set limit is reached.

## **Tips**

- If battery health protection is turned on, the charging SOC limit will return to the default value after the vehicle is powered on again. The charging SOC limit is 90% for models equipped with ternary lithium batteries, and is 100% for models equipped with lithium iron phosphate batteries.
- It is recommended to use the default limit value, which can effectively protect the health of the traction battery.

## Battery preheating at low temperature

### Introduction

When the vehicle is connected to the slow charging pile, you can use the low-temperature battery preheating function to heat up the



## Charging instructions

traction battery and improve the range in cold conditions.

### i Tips

It is recommended to start preheating 1 hour before departure.

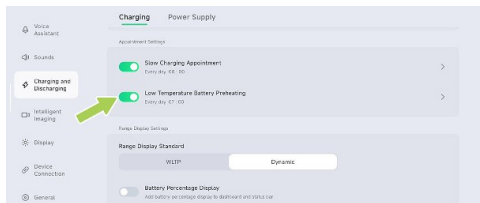

The preheating time can be set in the “**→Charging and Discharging→Charging**” interface of the central control panel, and the preheating can be turned on directly through the mobile App.

### i Tips

- When charging at low ambient temperature, the system will heat the traction battery first, and then charge normally after the temperature of the traction battery is normal. Therefore, the charging time will be slightly longer than normal.
- When the text message indicates that charging is abnormal, try to repeat the charging steps, restart the vehicle, and change to another charging pile. Do not repeatedly connect and disconnect the charging plug or operate the charging pile interface. If you still can not charge normally, please contact XPENG Service Center for maintenance in time.
- It is recommended not to turn on the A/C system during charging.



## Warning, caution and limitation

### caution

- To activate the battery preheating at low temperature, connect the charging plug and lock it to prevent the charging plug from being removed.
- It is recommended to use the vehicle as soon as possible after the traction battery is warmed up. Long time parking will reduce the heating effect.
- If the traction battery temperature is high, the battery preheating at low temperature will not be activated.
- If slow charging schedule function are activated at the same time, please ensure that the preheating time is set later than the scheduled charging time.
- This function will slightly increase the power consumption of the charging pile, please use it as needed.

- If the activation fails, please check whether the activation conditions of the function are met. If there is an abnormality, please contact the XPENG Service Center.

## Slow Charging Current Settings

### Operation

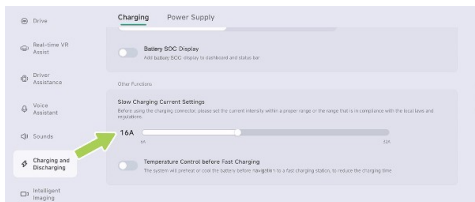

The slow charging current settings can be set on the “→**Charging and Discharging**→**Charging**” interface of the central control panel.



## Charging instructions

### i Tips

Before using the charging connector, please set the current intensity within a proper range or the range that is in compliance with the local laws and regulations.

## Temperature control before fast charging

### Introduction



In the “ → **Charging and Discharging** → **Charging**” interface of the central control panel, the temperature control before fast charging can be turned on. When the central control panel is

used to navigate to a fast charging station, the vehicle controls the temperature of the traction battery within the optimal charging range to shorten the charging time.

### i Tips

This function will heat or cool the traction battery, which will consume part of the remaining power of the traction battery.



## XPILOT hardware

### Radar

To ensure the proper operation of radars:

- Please keep the radar surface clean and free of ice, snow, water, dust and other foreign objects attached.
- When a foreign object is found on the radar surface, wipe it with a soft cloth or clean it up with water (at low water pressure).

### Camera

To ensure the proper operation of cameras:

- Please keep the camera surface clean and free of ice, snow, water, dust and other foreign matter.
- Please keep the front windshield clean.
- Keep the windshield in front of the camera clean, and there must be no objects between the camera and the windshield.

- When a foreign object is attached to the cameras surface, wipe it with a soft cloth or clean it with water (low-pressure water).

## Opening/closing of front hood

### Introduction

#### Opening of front hood





1. Continuously pulling the handle at the left lower of the instrument panel twice can make the front hood slightly pop up to unlock it.

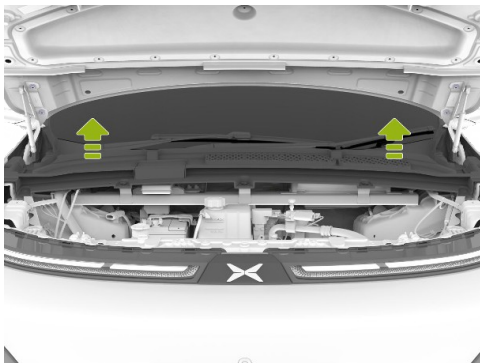

2. Slightly lift the front hood, and it will automatically rise to the limit position with the struts.

### Closing of front hood

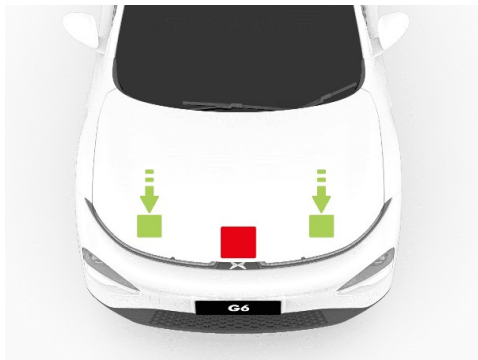

1. Lower the front hood until the front hood striker contacts the latch.
2. Place both hands on the front side of the front hood (green area as shown above), then firmly press down to close the front hood.
3. After closing, please check if the front hood is firmly locked. The ICM will display a prompt

## Daily maintenance



indicating the status of the front hood (open or close).

### warning

- Forces may only be applied to the green area shown in the illustration. Applying forces to the red area is likely to cause damage.
- Do not close the front hood with one hand to avoid concentration of force, which may cause dents or bends.
- Do not press on the front edge of the front hood to avoid bending the edge.

## Coolant

### Introduction

Please check the coolant level during the specified maintenance period.



Check the level mark on the side of the coolant reservoir:

- MAX: Upper limit mark
- MIN: Lower limit mark

The coolant level shall be between MIN and MAX marks. If it is lower than MIN mark, add the coolant authorized by XPENG timely.



### Operation

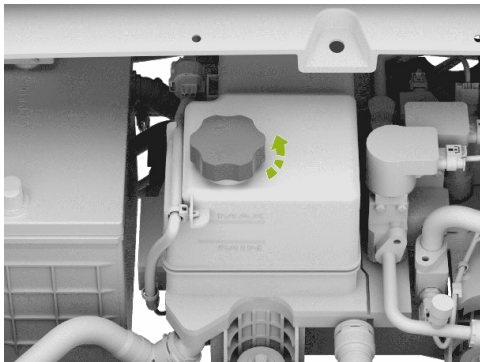

Unscrew the reservoir cap and fill the coolant.

In order to maximize the performance and life cycle of the traction battery, motor, and A/C system, a specific type of coolant is selected for the cooling system (select coolant with different freezing points based on the lowest temperature in the location)

### Brake fluid

#### Introduction

If the fluid level in the brake fluid reservoir is below the specified value, the brake light on the ICM will give an alarm. If an alarm is emitted during driving, pull over on the premise of ensuring safety and do not continue driving; And contact the XPENG Service Center immediately.

#### **⚠ warning**

- If you find that the brake pedal is loose or the brake fluid is significantly consumed, please contact the XPENG Service Center immediately. Driving under these conditions may increase the braking distances or lead to total brake failure.
- The brake fluid specifications are marked on the brake fluid packaging container. In any case, new brake fluid that meets the vehicle specifications must be used. Used brake fluid or inappropriate brake fluid will inevitably degrade the braking performance

## Daily maintenance



and even cause the braking system failure. It is recommended to use original brake fluid approved by XPENG.



Check the level mark on the side of the brake fluid reservoir:

- MAX: Upper limit mark
- MIN: Lower limit mark

The brake fluid level shall be between MIN and MAX marks. If it is lower than MIN mark, add the brake fluid authorized by XPENG timely.

### warning

- Add brake fluid until the fluid level is close to MAX line (but not above the MAX line). After adding brake fluid, refit the reservoir cap.
- The brake fluid is toxic. Please follow the requirements of relevant environmental regulations when releasing or disposing of used brake fluid.



### Operation

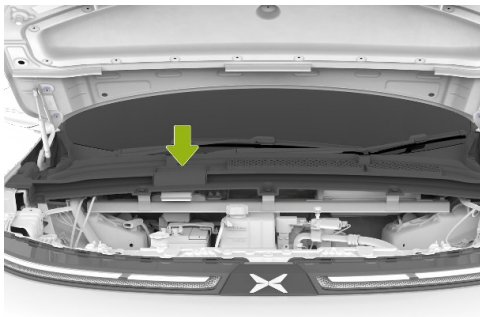

1. Wrap a flat head screwdriver in a cloth, open and remove the upper trim panel of the reservoir at the position indicated by the arrow in the figure.

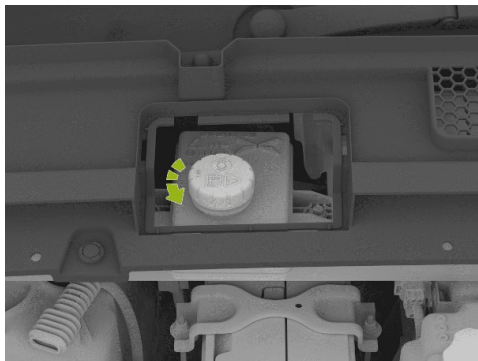

2. Clean the reservoir cap to prevent dust from entering.
3. Unscrew and remove the reservoir cap.
4. Fill the brake fluid approved by XPENG until the brake fluid is close to the MAX mark.



## Caution and limitation

### warning

- Use new brake fluid in a sealed container. Never use brake fluid in the used or opened container. Brake fluid can absorb moisture, reducing braking performance.
- Brake fluid is highly toxic. Containers must be kept tightly sealed and out of reach of children. In case of accidental ingestion, seek medical attention immediately.
- Brake fluid can damage painted surfaces, so absorb the spillage immediately with a cloth and clean it with a cleaner-water mixture.
- Some models have components in the front compartment that block the brake fluid reservoir, so it may not be possible to accurately check the brake fluid level. If necessary, contact the XPENG Service Center for inspection.
- The brake fluid level may drop slightly during the use of the vehicle due to brake pad wear and automatic adjustment, which is normal.

However, if the fluid level drops significantly in a short period of time, or drops below the “MIN” marking line, or if the fluid reservoir needs to be filled frequently, it indicates that there is a leakage in the brake system. Please contact the XPENG Service Center to check the brake system as soon as possible.

- If the fluid level drops below the specified limit, a warning light will go on. The ICM may display relevant text messages to prompt or alert the driver that certain operations must be performed immediately. In this case, stop the vehicle immediately and do not continue driving. Please contact the XPENG Service Center to check the braking system as soon as possible.
- If the brake system warning light does not go off or goes on while driving, it indicates that the brake fluid level is too low. To prevent an accident, stop the vehicle immediately and do not continue driving.



Please contact the XPENG Service Center as soon as possible.

- Brake fluid is hygroscopic, and can continuously absorb moisture from the surrounding air during use. If the brake fluid contains too much water, it will corrode the brake system and greatly reduce the boiling point of the brake fluid, which may produce air resistance during emergency braking, resulting in degraded braking performance. Therefore, the brake fluid must be replaced every 24 months or every 40,000 km, whichever comes first!
- Do not store the brake fluid in empty food containers, bottles, or any non-original brake fluid containers. Otherwise, the brake fluid may be mistaken for food, resulting in a poisoning accident!

### Windshield washer fluid

#### Introduction

Regularly check the washer fluid. If the level is too low, fill in the reservoir timely.

Operate the washer regularly and check whether the nozzle is clogged and can spray properly.



## Operation

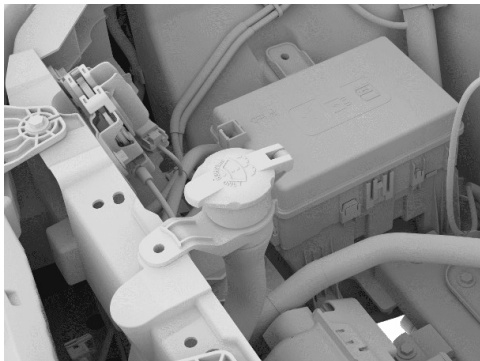

1. Clean the reservoir cap to prevent dust from entering.
2. Open the reservoir cap.
3. Add washer fluid until the fluid level reaches the lower edge of the filler.

### warning

Do not use windscreen detergent with ethanol content higher than 25%. In environment with high temperature, the glass detergent may cause surface damage.



### Wiper blade

#### Introduction

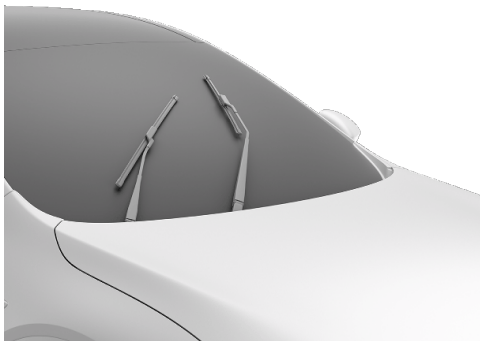

Shift to P gear and keep the wipers off. Tap “ → **Vehicle**” on CID to turn on the front/rear wiper maintenance mode, and the wiper arm will operate to the maintenance position. After turning off the wiper maintenance mode, the

wiper arm will automatically return to its original position.

#### **caution**

Before replacing the wipers, you must turn on the wiper service mode, otherwise, vehicle damage can occur.



## Operation

### Replacement of front wiper blade



1. Lift the wiper arm, press the lock button, and pull out the wiper blade in the direction perpendicular to the wiper arm.
2. Install the new wiper blade back into the wiper arm by following the opposite steps, and if

you hear a “click” sound, it indicates that the blade is installed in place.

3. Gently place the wiper arm back onto the windshield.
4. Disable the front wiper maintenance mode.

### Replacement of rear wiper blade

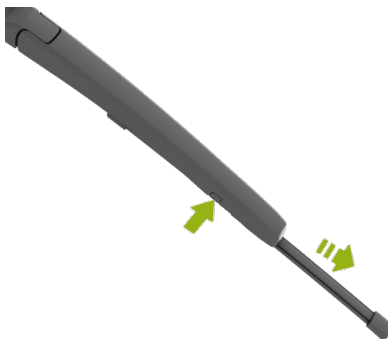

1. Press and hold the wiper blade, remove the wiper blade by pulling the wiper arm upwards



along the connection between the wiper arm and blade.

2. When installing, lift the wiper arm, clip the protruding position on the new wiper blade into the slot of the wiper arm and if you hear a “**click**” sound, it indicates that the blade is installed in place.
3. Gently place the wiper arm back onto the windshield.
4. Disable the rear wiper maintenance mode

### **i** Tips

- If you need to replace the wiper blades, it is recommended to go to the XPENG Service Center for replacement.
- Please lift the wiper arm for the cleaning of glass, wiper blades or replacement of wiper blades. Do not grab the wiper blade directly to avoid deformation of the wiper blade, which otherwise may make the wiper noisy and affect the wiping effect.

## Traction battery

### Introduction

The traction battery is mounted on the underside of the vehicle, so drive with caution!

#### **⚠** caution

- Carefully drive the vehicle through special road surfaces such as mud, potholes, curbs, higher and wider artificial bumps, and sidewalk ramps, etc., to avoid chassis collisions that may cause traction battery scratches or damage.
- Carefully drive the vehicle through standing water to avoid short circuit, leakage or damage of the traction battery due to excessive contact with water.
- If you feel that the chassis has been scratched, or the traction battery emits a strange odor, etc., you should immediately stop using the vehicle and contact the XPENG Service Center.



## Range

The range depends on factors such as the vehicle's available power, the driving range and time, ambient temperature, road conditions, driving habits (A/C, driving modes, recycled energy level), and the vehicle loads.

## Ambient temperature of traction battery

The ambient temperature affects the performance of the traction battery, and it is required to use the vehicle within the ambient temperature range of  $-30^{\circ}\text{C}$  to  $55^{\circ}\text{C}$  in order to maintain the good performance of the traction battery and prolong the life cycle of the traction battery.

### **caution**

Do not park the vehicle in a place with ambient temperature above  $55^{\circ}\text{C}$  or below  $-30^{\circ}\text{C}$  for a long period.

## Maintenance and recycling of traction battery

Even if the vehicle is not used, the traction battery will slowly discharge. Low SOC will shorten the life cycle and performance of the traction battery, affecting the vehicle range. Therefore, before parking the vehicle for a long time, check the SOC of the traction battery to keep it at 30%~60%. If the SOC is low, please charge it before parking.

Refer to the relationship table between different battery powers and parking time to ensure parking with sufficient power:

Range or SOC	30%	50%	60%
Parking days	$\leq 90$ days	$\leq 150$ days	$\leq 180$ days

It is recommended to power on and check every 3 months. If the battery SOC is too low, charge



timely, otherwise the performance of the traction battery may be affected due to power depletion.

The life cycle of traction battery is also affected by ambient temperature. When the ambient temperature is too low, the driving range of the vehicle will be reduced and the charging time will increase.

### **i** Tips

- Recommended charging working temperature: 0 ~ 45°C. The charging time will be extended if the ambient temperature is lower than 0°C.
- Parking the vehicle in a hot or cold environment for a long period will accelerate the loss of the traction battery. It is recommended to park the vehicle in a cool, dry and ventilated place without low-lying areas, away from heat sources (such as heating pipes) flammable and explosive materials and corrosive substances.
- Avoid wading for a long distance or a long time.

- Do not discharge the traction battery completely.

### **Maintenance of LFP battery**

If the LFP battery is used by the vehicle, please follow the following suggestions to allow the more accurate estimation of the range and prolong the life cycle of the traction battery.

- Charge the battery to 100% SOC as soon as possible after picking up the vehicle (fast charging recommended for first three times). After that, it is recommended to set the charging SOC limit to 100%, and fully charge the battery at least once every 2 weeks or every 1,000km (fast/slow charging).
- In winter, when the temperature is low, it is recommended to keep the range not less than 100km.
- When the vehicle is parked, avoid turning on the 12V delayed power-off function of the trunk for a long period of time to reduce the power consumption of the vehicle. If the vehicle is parked for more than a week, it is



recommended to charge the battery to 100% SOC once.

### Instructions for traction battery recycling

If the traction battery needs to be replaced or scrapped, please contact XPENG Service Center for recycling and disposal. Careless disposal of traction battery will cause pollution to the environment or safety accidents, and the vehicle owner should be held responsible.

### Caution and limitation

#### warning

- The traction battery can generate a rated voltage far beyond the safety voltage of human body, which may cause serious injury or even death to human body. Please beware of the high voltage danger!
- Only trained technicians are allowed to disassembling, checking, modifying, and repairing the traction battery and its circuits. Otherwise it may lead to electric shock

injury or even death due to improper operation.

## Charging stand

### Introduction

For normal use, clean with a high-pressure air gun or brush every week. If it is impossible, use a dust-free cloth or cotton swab to clean the charging stand and charging plug.

#### warning

Do not touch the charging plug pins and the charging stand socket by the sharp objects such as screwdrivers, tweezers, etc. to avoid damaging the pins and the socket.

## Tire

### Inspection and maintenance of tires

Please check the tire pressure regularly. If the tire pressure is insufficient, be sure to adjust it to



## Daily maintenance

the specified value on the tire pressure label on the driver side B-pillar.

Regularly check the tread for abnormal wear, nails, etc Regularly check the tire wall for bulges, cuts, etc.

### Tire wear

Sufficient tread depth is crucial for the tire performance. Tires with a tread depth less than 2mm are easily slipping under slippery road conditions, so they are not recommended Tires with a tread depth of less than 4mm will have poor performance on snowy and muddy roads, so they are not suitable for driving in winter.

To reduce tire wear and extend tire life, please service the tires according to your driving habits and road conditions:

- Avoid rapid departure or coarse acceleration.
- Avoid sharp turns and heavy braking
- Slow down when driving over potholes, curbs, or similar sections of the road.

- It is recommended to rotate the tires every 10,000km.

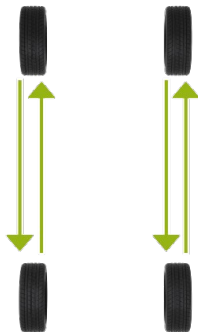

### Replacement of wheel and tire

Tires will age over time due to UV rays, extreme temperatures, high loads, and environmental conditions. They may also have normal wear during normal acceleration, braking, and turning. XPENG Service Center will check the tire



wear condition during vehicle maintenance, and recommend replacing tires if necessary. In case of special circumstances, such as the tire tread wearing down to the wear mark, or a foreign object scratches or punctures the surface of the tire, go to XPENG Service Center immediately to replace the tire.

### caution

Please use the tires and hubs with the same specifications as those of the original tires and hubs. Tires with different specifications will affect the normal operation of the XPiLOT function and the TPMS.

### warning

- Do not drive the vehicle if the tires are damaged, excessively worn or have incorrect pressure. Regularly check the tire for wear without cuts or bulges.
- After replacing or repairing the tires, perform the dynamic balancing of wheels.

## Type of seasonal tire

### Summer tire

Summer tires are suitable for extremely dry or wet roads, but not for winter. Winter tires are recommended when driving in cold weather or on icy roads.

### All-season tire

These tires are designed to provide sufficient traction in all seasons of the year, but may not provide traction comparable to winter tires on icy and snowy roads. **“ALL SEASON”** and/or **“M+S”** (mud and snow) markings are visible on the tire walls of all-season tires.

### Winter tires

Winter tires can improve the traction in icy conditions. When fitting winter tires, always fit a set of four tires at the same time and all four wheels must have the same size, brand, structure, and tread pattern of winter tires, contact XPENG Service Center for advice on winter tires.



When driving a vehicle with winter tires fitted, you may experience increased road noise, shortened tread life and reduced traction on dry roads.

### warning

- If the tire is worn unevenly and excessively, please go to XPENG Service Center in time to check the wheel balance and wheel alignment.
- Underinflation is the leading cause of tire failure. It may cause overheating, tire cracking, tread separation or tire blowout leading to accidental vehicle loss of control and increased risk of injury.
- Underinflation can also shorten the vehicle range and the service life of tread.
- Do not use any tire sealant (except those provided in the emergency tire repair kit), otherwise, a malfunction of tire pressure sensor may occur.

### Tire pressure monitoring system (TPMS)

TPMS can monitor the tire pressure and temperature in real-time during driving, and provide alarm in case of abnormal tire pressure, temperature, or abnormal TPMS system to ensure driving safety.

### warning

- When the tire pressure or TPMS is abnormal, the ICM will illuminate the TPMS indicator and give a text message: “**Low tire pressure, please inflate the tire in time**”, “**Low tire pressure, please inflate the tire immediately**”, “**TPMS fault, please go to a service center for maintenance**”. Please strictly follow the instructions for troubleshooting.
- It is prohibited to modify the TPMS at will.



### Tire pressure calibration

The tire pressure will be automatically calibrated whenever the tire is replaced. Please keep the vehicle stationary for at least 17min before calibration. During the calibration, drive the vehicle at a speed of over 40km/h for 10min and avoid reversing.

### Using snow chains

When you drive the vehicle in a severe environment such as snowy or icy roads in winter, use snow chains to increase tire friction and reduce side slip. For the use of snow chains, the following suggestions must be followed:

- When driving in deep snow, it is necessary to install snow chains on the tires. The vehicle is not equipped with snow chains, and the vehicle owners can purchase ones as needed. To install snow chains, you must choose an equivalent of a size and type that matches the specifications of the tires on your vehicle.
- Snow chains installed on your tires can ensure that you can drive in a balanced manner in all types of weather. It should be borne in mind that the vehicle may not have enough traction after installing the chains. Drive carefully, even when the road conditions are good. Do not exceed the speed limit of the tire snow chains, or exceed 50km/h, whichever is lower.
- Only use snow chains on the rear wheels. Install snow chains in pairs. Self-tensioning snow chains are strictly prohibited.
- Do not use tire chains on dry roads. Please remove the tire chains before driving on snow-free roads.
- After installing the snow chains as close as possible to the tires and driving for 0.5-1.0km, tighten the chains again.
- If the vehicle is equipped with wheel trim covers, please remove them before installing the tire chains.
- If you hear the friction or collision sound between the snow chain and the vehicle while driving, stop and re-tension the snow chain. If



it does not work, remove the snow chains to prevent damage to the vehicle.

- Use fine-mesh snow chains.They must not add more than 0.53 inch (13.5 mm) in height, including the chain lock.

### Brake pad

#### Introduction

It is recommended to check whether the brake pads are worn to the alarm limit during each maintenance or before long distance traveling.

If brake noise is heard during braking, it is recommended to check the brake pads and replace them if they are worn to the alarm limit.

Replace the brake pad with the original part.

### Exterior cleaning

#### Introduction

##### Exterior cleaning

Washing vehicle frequently helps maintain the vehicle in good appearance.

Keep the vehicle in a cool place away from direct sunlight when washing. Please wait until the exterior of the bodywork has cooled before washing it to prevent the paint damage caused by sunlight exposure.

When washing will be done through an automatic car washer, be sure to follow the instructions of the washer operator.

In case of washing under high pressure, please direct the water flow at the window instead of the edge of the window so as to prevent water from injecting the inside of the vehicle.

After washing the vehicle in cold winter, dry the water in the grooves around the door handle to avoid freezing.



To prevent damage to the paintwork, remove corrosive substances (bird droppings, resins, insects, asphalt spots, paving salt, industrial dust, etc.) immediately.

The washing of the exterior of the body should be implemented as follows:

### 1. Preparations before cleaning

Close the doors, trunk and front hood, and check that the charging port is fully closed

### 2. Rinse thoroughly

Rinse off the dirt and grit from the vehicle body with a hose before washing. Rinse areas that may easily accumulate dust, mud or road salt, for example, wheel arch and panel joint.

### 3. Hand washing

Add a high-quality neutral vehicle cleaner in cold or warm water, dip the soft cloth wet, and hand wash the outside of the vehicle body.

### 4. Rinse with water

After washing, rinse with clean water to prevent any residual soap liquid on the surface from getting dry.

### 5. Dry with a soft cloth

#### **caution**

- Do not use hot water and detergent.
- When using a high pressure washer, keep the nozzle moving at least 30cm away from the surface of the vehicle body, and do not keep spraying water towards a certain area. Do not spray water towards the charging port.
- When washing the vehicle at low temperature, or parking outside in snowy days, the active grille shutter (AGS) may not work properly due to icing, and the ICM will display the AGS fault, which is normal and does not affect the normal use of the vehicle. After driving for a period of time (about one hour) or using the heat gun for defrosting, the fault will be eliminated



automatically, otherwise, contact the XPENG Service Center for maintenance.

- Do not spray water from the hose directly toward the windows, door seals or through the wheel hub holes into the brake parts.
- Avoid using lint or coarse cloths, such as car washing gloves.
- Do not use chemical tire cleaners as they may damage the finished wheel surface.
- When washing the vehicle, avoid using a high pressure washer to spray water on the charging port cover opening/closing area, as this may cause the charging port cover to open.

### Cleaning, caring for external plastic parts

Clean with water as well as a soft cloth or a soft brush.

### Washing of windows and mirrors

The windows and rearview mirrors should be cleaned with alcohol-based glass cleaner. After

cleaning, the surface of the glass should be dried with clean, soft, lint-free cloth.

The residual wax on the glass due to the maintenance of body surface should be removed with special cleaner and cleaning cloth to prevent the wiper blade from being scratched.

Remove snow from windows and mirrors with a small brush.

The accumulated ice can be removed by deicer spray or deicing shovel. However, you must be specially cautious to avoid damaging the parts, and the ice must be scraped in the same direction.

### caution

- Do not use warm or hot water to remove snow or ice from the windshields and rearview mirrors, as this may cause the glass breakage.
- Remove the residual rubber, grease and silicone substances on the glass with a



special window cleaner or silicone cleaner if any.

### Maintenance of sealing strip

Remove dust and dirt from the surface of the sealing strip using soft cloth during maintenance. Regularly apply special protective agent to the surface of the sealing strip.

### Wiper blade cleaning

Regularly clean the edge of the wiper blade and check for cracks, rips and roughness in rubber. If damaged, please contact the XPENG Service Center for replacement.

The contaminants on wiper blade may reduce the effectiveness of the wiper blade. The contaminants include ice, vehicle wash wax, cleaning fluids containing bacteria or waterproof agent, bird droppings, tree leaves and other organic materials.

Please clean the wiper blades as follows:

- Clean the windshield with a nonabrasive glass cleaner
- Tap “🚗 → **Vehicle**” on the CID and open “**Front Wiper Maintenance Mode**” or “**Rear Wiper Maintenance Mode**” in the current menu interface to activate the front/rear wiper maintenance mode.
- Lift the wiper arm slightly from the windshield to get close enough to the wiper blade, then wipe the blade clean with isopropyl alcohol or wiper cleaning fluid.
- If the wiper blades are still ineffective after cleaning, they may need to be replaced.

#### **caution**

- Lower the wiper arm carefully to prevent it from dropping momentarily and striking the windshield.
- The wiper blades are coated with a layer of graphite, which makes the wiper work smoothly without noise. Solvent cleaners, hard sponges and sharp objects can damage the graphite layer. If the graphite



layer is damaged, the wiper will be noisy and should be replaced in time.

- In winter or cold weather conditions, check and ensure that the wiper blades are not frozen to the windshield before using the wipers. If the wiper blades are frozen, remove the ice first, otherwise, the wiper blades and wiper motor will be damaged.
- Please lift the wiper arm for the cleaning of glass, wiper blades or replacement of wiper blades. Do not grab the wiper blade directly to avoid deformation of the wiper blade, which otherwise may make the wiper noisy and affect the wiping effect.

### Windshield cleaning

Clean the windshield with a non-abrasive glass cleaner.

Contaminants on the windshield may affect the hydrophobicity of the glass, so please clean it promptly. Contaminants include dust and oil film, bird droppings, leaves, and other foreign matters.

#### **caution**

- Do not use cleaners containing ammonia or chlorine, such as household window cleaners, as this will accelerate the aging of the wiper blades.
- Do not use water-repellent materials (e.g. wax, crystal wax, etc.) to clean the windshield, which will increase the water repellency of the glass surface and affect the cleanliness of the windshield.

## Interior cleaning

### Introduction

Check and clean the interior frequently to keep the interior looking neat and new and prevent premature wear and tear.

#### **caution**

- Plasticizer-free automotive products are recommended. If the plasticizer content of the automotive products is too high, it



will react with the PU interiors, resulting in bulging and other problems.

- To avoid interference with the pedals, make sure that the floor mat on driver side is properly secured and do not overlap other floor mats on it. Floor mat should always be placed on the carpet surface of the vehicle.
- The solvents (including alcohol), bleach, citrus cleaners, naphtha, silicone-based products or additives can damage the interiors.
- Statically charged substances can cause damage to the CID and instrument panel.
- Do not use wet tissues, wet cloths, detergents, etc. to wipe the door guard plates, and take care to protect them from water during the use of the vehicle (e.g., rainy days, vehicle washing) as much as possible, as this may lead to malfunction of the internal electrical components, etc.
- If the airbags or seat belts are damaged, please contact XPENG Service Center immediately.

- The seat belt components are strictly prohibited to be damaged by water, detergent or fabrics.

### Interior glass

Scratching or using any abrasive cleaning solution on the glass or mirror surface is strictly prohibited. Otherwise, the reflective surface of the mirror and the rear window heating element may be damaged

### Instrument panel and plastic surfaces

Polishing of the surface of the instrument panel is strictly prohibited, as the polished surfaces tend to reflect light and may interfere with driving visibility.

### Seats

Wipe the stain as soon as possible with a soft cloth dampened with warm water and neutral soap. Wipe gently in a circular motion, then dry with a soft lint-free cloth.



### Seat belt

Pull out the seat belt and wipe it. Do not use any type of cleaner or chemical cleaner. Allow the extended seat belts to dry naturally.

### Carpet

Use a vacuum cleaner with soft brush to clear dust and surface debris. For stubborn stains, try using water or baking soda solution to remove them. Please select an appropriate method to remove the stains prior to cleaning:

- For liquid stains: Gently wipe the residues with a paper towel, allowing the stains to soak and be absorbed by the paper towel as much as possible.
- For solid and dry stains: Remove as much as possible manually first, then use the vacuum cleaner to clean up the remaining residues.

### CID and instrument panel

Clean the CID and instrument with a special soft lint-free cloth. Do not use cleaners (such as a glass cleaner), wet wipe or a dry statically-

charged cloth (such as a recently washed microfiber).

Tap “☰ → **Display** → **Screen Cleaning**” or swipe down the quick menu on CID to enable clean mode and wipe the CID, which will not activate buttons or change settings.

#### **caution**

Do not clean the CID with corrosive liquids such as acids and alkalis, deoxidizing detergents, sodium hypochlorite (84 disinfectant), etc.

### Chrome-plated and metal surfaces

Polishes, abrasive cleaners, or hard cloths can damage the chrome-plated surface and the finish of the metal surface.

### Floor mats

To extend the life of the vehicle carpet and for easy cleaning, please use genuine floor mats approved by XPENG. Regularly clean the floor mats and ensure they are properly installed. If the

## Daily maintenance

---



floor mats are excessively worn, replace them in time.



### Emergency devices

#### Emergency devices

##### Hazard warning light



In the case of an emergency during driving, press the hazard warning light button to turn on the hazard warning lights and the turn signal lights

flash. Press the button again to turn off the hazard warning lights.

##### **i** Tips

Hazard warning lights can be turned on regardless of the vehicle power supply.

##### Trunk emergency device



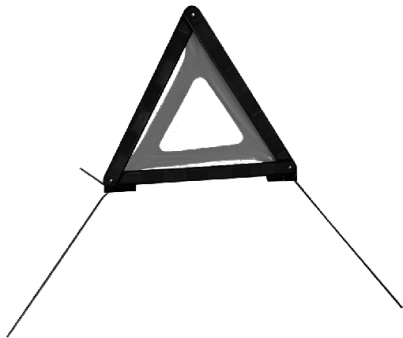

## 1. Warning triangle

In the case of an emergency after parking, take out and place the warning triangle at the rear of the vehicle as shown in the following figure .

General road	General road	Highway
--------------	--------------	---------

Day	Night	Highway
≥ 50m	≥ 80m	≥ 150m

## 2. Driver's tool

Driver's tool includes: towing hook and wheel nut pliers.

## 3. Reflective vest

In case of an emergency, please take out the reflective vest from the trunk and put it on. Wearing a reflective vest can increase visibility and reduce the risk of accidents.

## 4. Emergency tire repair kit

### Emergency tire repair

#### Emergency tire repair

No spare tire is available to the vehicle but an inflatable emergency tire repair kit is included with the vehicle.



The emergency tire repair kit includes an inflatable pump and a can of tire sealant (for one tire only). When injected into the tire, the tire sealant will penetrate into small punctures on the tire by no more than 6mm for an emergency repair.



### warning

- For punctures larger than 6mm, severe tread damage, sidewall damage, tire tearing or tire falling off, please contact XPENG Service Center.
- The emergency tire repair kit is only used for a single temporary repair of a damaged tire, which must be repaired or replaced as soon as possible.
- If the tire is temporarily repaired with the tire sealant, the driving speed must not exceed 80 km/h.
- Please read and observe all warnings and instructions on the label of emergency tire repair kit.
- It is strictly forbidden to continue driving when a flat tire is detected, otherwise, serious personal injury may occur.

### Tire sealant

The tire sealant in the emergency tire repair kit is specially designed for XPENG vehicles,

## Emergency rescue



which will make no damage to the tire pressure sensor. Therefore, it can only be replaced with tire sealant of the same type and capacity. Tire sealant can be purchased from XPENG Service Center.

The product expiration date is printed on the outside surface of the tire sealant. If the service life expires, the tire sealant can not work as expected. Be sure to purchase a new tire sealant.

### warning

- Do not use tire sealant purchased from channels other than service center, otherwise, a malfunction of tire pressure sensor may occur.
- Always read and follow the safety and operating instructions for tire sealant.
- Keep the tire sealant out of reach of children.
- In the case of eye contact, flush with water and seek medical attention immediately.

- In the case of accidental ingestion, seek medical attention immediately.
- In the case of inhalation, get fresh air and seek medical attention immediately.

## Tire inflation

Temporarily repair small tire punctures (less than 6 mm) according to the steps below:





## Emergency rescue

1. Take out the emergency tire repair kit from the trunk.
2. Take out the inflatable pump and tire sealant from the emergency tire repair kit.



3. Take out the tire sealant and shake it well.



4. Screw one end of the tire sealant injection tube into the tire valve and tighten it. Be careful not to invert the tire sealant can.



5. Connect the other sealant injection tube to the inflatable pump and tighten it, and then connect the power cord of the inflatable pump to the 12V power supply in the vehicle storage box.



6. a. Switch on the inflatable pump to inflate the tire.  
b. In the process of sealant injection, the value on the pressure gauge may be approximately 300-600kPa.  
c. Observe the pressure gauge until the tire pressure reaches the standard value before stopping inflation.



- d. For tire specifications and standard tire pressure values, please refer to the tire pressure label.
  - e. Check the tire pressure, if it cannot reach the set value within 20min, it will be deemed as tire repair failure.
7. Turn off the inflatable pump, and then pull out the sealant injection tube from the tire valve. Wipe off the excess sealant from the tire valve and the wheel hub. Pull out the sealant injection tube from the inflatable pump, and put the emergency tire repair kit back to the trunk.
  8. Drive the vehicle immediately for 5km or 10min at a speed of 20~60km/h to allow the sealant spreading evenly throughout the entire tire.
  9. Stop the vehicle to check the tire pressure.

 **caution**

If the tire pressure is lower than 130kPa, it indicates that the damaged tire can not be repaired by using tire sealant. At this

time, please park the vehicle safely on the roadside and contact the XPENG Service Center.

10. Inflate the tire to the standard tire pressure.
11. Store the inflatable pump back into the trunk.
12. Drive the vehicle at a speed of 20~80 km/h to XPENG Service Center for tire repair.

 **caution**

- Repair or replace the tire as soon as possible.
- After using the tire sealant, please purchase a new one in time.
- Do not drive the vehicle at a speed above 80km/h.

## Emergency rescue



### Inflation only



1. Take out the emergency tire repair kit from the trunk.
2. Take out the inflatable pump from the emergency tire repair kit.



3. Take out the inflatable tube and the power cord from both sides of the inflatable pump
4. Attach the inflatable tube to the tire valve and tighten it.
5. Connect the power cord of the inflatable pump to the 12V battery in the vehicle.



6. Switch on the inflatable pump to inflate the tire.
- Observe the pressure gauge until the tire pressure reaches the standard value before stopping inflation.
  - For tire specifications and standard tire pressure values, please refer to the tire pressure label.

7. Switch off the inflatable pump.

**! caution**

- Please inflate the tire to the specified value, because that the overinflation and underinflation will accelerate the tire wear.
- In the case of overinflation, reduce the tire pressure value by deflating the tire as follows.
  - Operation procedure: Remove the inflatable tube, press and hold the metal rod in the center of the valve to deflate the tire, during which you can connect the inflatable tube to check the reading on the air pressure gauge until the tire pressure is reduced to the specified value.
- After adjusting the tire pressure, if the TPMS indicator does not go out, please drive the vehicle at a speed of 40km/h for a short period of time and check the recovery of the indicator.

# Emergency rescue



- After driving for a period of time, the tire pressure will increase slightly as the tire temperature rises, which is normal.
- If the indicator is still illuminated, please contact the XPENG Service Center.

## E-call

### Introduction



In the case of an emergency, please call for rescue by the following ways:

- Manual call: Press and hold the SOS button for more than 3s, and the system will call for rescue. If you want to cancel the call while waiting for connection, just press the button again.
- Automatic call: When the vehicle airbag is deployed in a collision, the system will automatically call for rescue.
- Callback: When the call is not connected or interrupted, the system supports callback within a certain period of time.

#### **i** Tips

- During the call waiting or after the call is answered, the SOS button indicator will be green. When the system is faulty, the SOS button will be red and you should get help by other means.
- After the call is answered, it can only be ended by the rescuer.



- The E-call will be invalid after expiration, please pay attention to the E-call expiration date on the CID in time.
- In the case of battery failure, the call for rescue can be continued for a period of time.

### Rescue protective equipment

#### Introduction

The vehicle power system is equipped with a traction battery, which may cause high-voltage leakage in the event of a severe collision. Therefore, the vehicle shall be operated by professional rescue personnel wearing proper protective equipment to ensure personal safety.

#### warning

When operating the vehicle, please make sure that you are not carrying metal products (such as necklaces, watches, etc.) to avoid electric shock.

#### Electrical protection

Wear the following protective equipment to avoid injuries from high voltage shock:

- Rubber insulation gloves (capable of insulating voltages above 500V).
- Goggles.
- Rubber insulating shoes.
- Tools with insulated protective sleeves.

#### Chemical protection

In case of an electrolyte leak from the traction battery, wear the following protective equipment to prevent injuries to the skin, face, and other body parts:

- Protective masks.
- Solvent insulating gloves.



## Collision protection

### Introduction

The vehicle has the functions of cutting off and releasing high voltage. If a collision occurs and the conditions of collision protection triggering are met, the vehicle will automatically cut off the high-voltage power supply. At the same time, it will remind the occupants to leave the vehicle as soon as possible by sound, text, and other means, thereby avoiding disasters and injuries.

## Jump starting

### Operation

If the battery SOC is too low to start the vehicle, jump starting is recommended.

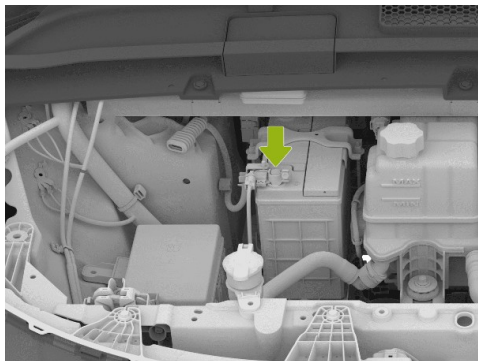

1. Open the trim cover on the positive terminal of the battery.
2. Connect one end of the red cable to the positive (+) terminal of the vehicle battery and the other end to the positive (+) terminal of the auxiliary power supply.

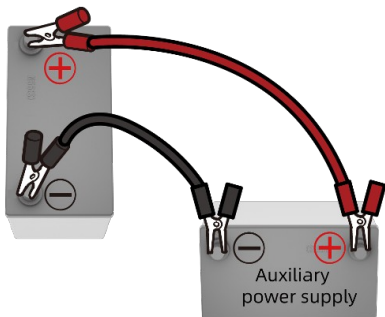

3. Connect one end of the black cable to the negative (-) terminal of the vehicle battery and the other end to the negative (-) terminal of the auxiliary power supply.
4. Start the vehicle. After it is started successfully, remove the connected cables in reverse order and restore the battery cover.

### warning

- Improper use of connection cables may lead to the explosion of the battery, causing the personnel injury.
- The voltage and capacity of the auxiliary power supply must be the same as those of the vehicle battery, otherwise, it may cause an explosion.
- The battery shall not be exposed to open flame or static electricity, otherwise, the flammable gas produced by the battery may be ignited by a spark and cause an explosion.
- Do not touch high voltage parts during operation to prevent injury from high voltage electric shock.

## Emergency rescue



### Emergency unlocking of charging port

#### Operation

If the charging plug still cannot be removed after the vehicle has been unlocked several times, it can be removed by the following operations:



- Open the trunk and use the appropriate tool to open the trunk access cover.
- Locate and pull the charging port emergency release ring, unlock and remove the charging plug.

### Electric door emergency opening and closing

#### Operation

The doors can be opened in an emergency by the following operations.

#### **caution**

Pull the door emergency opening handle once to open the door while driving; Do not pull the emergency opening handle in non-emergency situations.



### Emergency opening of front door



Press the front part of the driver door handle to pop out the flush door handle, insert the mechanical key into the lock hole, turn counterclockwise and then pull the handle to open the door.

#### **i** Tips

- The mechanical key is provided with the vehicle and is not integrated with the I-key. Please store the mechanical key separately and keep it in a safe place for use in case of emergency.
- When opening the door, turn the mechanical key back to the initial position before it can be removed. If the key cannot be turned during operation, insert the key to the bottom to continue turning.
- The alarm will be given when the door is opened, and will be deactivated when the key is used to unlock the door or when the emergency is activated.



Pull the emergency opening handle at the side of front door storage box to open the door.

### Emergency opening of rear door



1. Press open the access cover below the rear door armrest.
2. Pull the emergency opening handle to open the door.

#### **i** Tips

Close the door and the door is locked.



### Emergency opening/closing of trunk

#### Operation

The trunk can be opened by the following operations in an emergency:

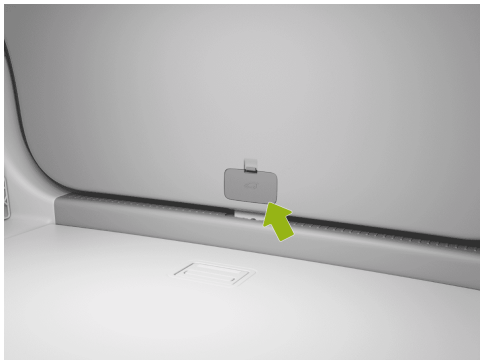

1. Fold and lower the rear seat backrests to access the trunk.

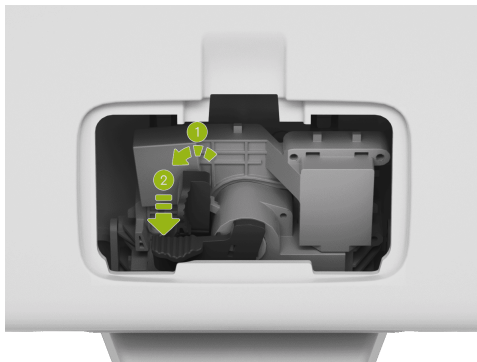

2. Open the trim cover on the emergency unlocking device.
3. First push the lever ① to the left and hold, next press the lever ② to unlock the trunk, and then push the trunk outward to open it in an emergency.
4. Press down on the trunk to close the trunk.

# Emergency rescue



## Vehicle emergency starting

### Operation

If the instrument displays the message “**Please replace the key battery**”, it indicates that the I-key battery is very low. At this time, you should replace the battery in time. Otherwise the vehicle cannot be started unless try the emergency start:



1. Put the I-key at the position of the arrow on the dashboard.
2. Depress brake pedal and shift the gear into R or D, and the vehicle will start.

### i Tips

The vehicle can also be started by the cellphone App Bluetooth key [See 157 page](#).

## Emergency power-off

### Operation

Emergency power off can be performed by the following methods:

The vehicle can be powered off in an emergency when the driver's seat is occupied or the door is open.



## Emergency rescue



- When the vehicle is stationary or running at a speed, press the emergency power-off switch for 3 times within 2s to power off directly.
- When the vehicle is stationary, press and hold the emergency power-off switch for 5s to power off directly.
- When the vehicle is driving, press and hold the emergency power-off switch for 5s, and a prompt pop-up window will appear on the ICM, and the vehicle can be powered off only after tapping to confirm.

### Initialization of windows

#### Operation

When the one-button closing and anti-pinch function fails, you can try the following initialization procedure:

1. Power on the vehicle and close all doors. Pull the window switch lightly to position I (manual lifting mode) to fully close the window for 3s, and then release the switch.
2. Press the window switch with force to position II (automatic lowering mode) and release, the window will automatically lower to the fully closed position.
3. Pull the window switch with force to position II (automatic lifting mode) again, and the window will automatically lift to the fully open position.



You can check if the initialization is successful with the following operations. If all items are normal, it indicates that the initiation is successful:

1. Repeat the above step 2 to check whether the window can automatically lower to the fully open position.
2. Repeat the above step 3 to check whether the window can automatically lift to the fully closed position.

## **caution**

- Setting the window to fully open or fully closed position needs to be completed within 15 s.
- Setting the window to fully open or fully closed position must be completed consecutively. If only one of the steps is done, the anti-pinch function may fail. To avoid this risk, two steps must be done consecutively.

## Initialization of seats

### Operation

If the seat function goes abnormally when you are using (such as failed to adjust the seat via button, CID and voice assistant), you can try to initialize the seat manually and then use it.

### Initialization operation of the front seats

1. Move the backrest angle adjustment switch forward to adjust the backrest to the foremost position, then release it.
2. Move the switch forward and confirm that the backrest is moved to the foremost position, then release it.
3. Move the switch forward again within 5s and hold it for more than 5s and then release it. If the seat starts to adjust its position by itself, it indicates that the seat initialization is successful.
4. Use the seat after the seat is stopped.



## Vehicle type and parameters

### Dimension parameters

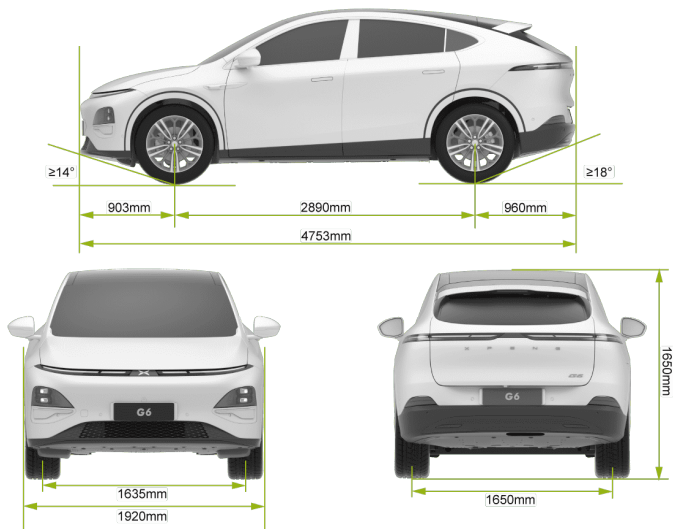

## Vehicle identification



Outline dimensions	Length (mm)	4753
	Width (mm)	1920
	Height (mm)	1650
Wheel track	Front track (mm)	1635
	Rear track (mm)	1650
Wheelbase (mm)		2890
Front overhang (mm)		903
Rear overhang (mm)		960
Seating capacity (person)		5
Approach angle (full load)(°)		14
Departure angle (full load)(°)		18



### **i** Tips

The exterior rearview mirrors (left and right) are not included in the overall dimensions, and the allowable tolerance range of the vehicle dimension parameters is  $\pm 1\%$ .

### Mass parameters

Project Name		Long-range model	Ultra-long range model
Curb weight of complete vehicle (kg)		2025	2048
Curb	Front axle (kg)	944	939
	Rear axle (kg)	1081	1109
Maximum total mass (kg)		2553	
Maximum	Front axle (kg)	1106	
	Rear axle (kg)	1447	

### **i** Tips

The tolerance range of mass parameters is  $\pm 3\%$ , except for the maximum total mass.

# Vehicle identification



## Performance parameters

Minimum turning diameter (m)	11.6
Maximum vehicle speed (km/h)	200
Maximum gradeability (%)	30



## Wheels and tires

Tire		235/60R18	255/45R20
Wheel rim		18×7.5J	20×8.5J
Pressure	Front wheel (empty half load/full load) (kPa)	250	
	Rear wheel (empty half load/full load) (kPa)	270	
Wheel dynamic balance (with balance weights)	Inner side of front wheel (g)	≤8	
	Outer side of front wheel (g)	≤8	
	Inner side of rear wheel (g)	≤8	
	Outer side of rear wheel (g)	≤8	



## Main parameters of traction battery

	Item	Unit	Long range vehicle model	Ultra long range vehicle model
Cell	Type	/	LFP	NCM
	Rated voltage	V	3.16	3.67
	Rated capacity	Ah	129	159
Traction battery	Rated voltage	V	512	550.5
	Rated capacity	Ah	129	159
	Rated energy (1C)	KWh	66	87.5
	Mass (including guard plate)	kg	569±10	559±15



## Brake and suspension

Type	Floating caliper ventilated disc
Type of assist	Electric assist
Brake pedal free travel or idle travel (mm)	≤2
Wear limit of brake pad for the front wheel (excluding the backing plate for brake pad)	2.3
Wear limit of brake pad for rear wheel (excluding the backing plate for brake pad)	3.3
Wear limit of front brake disc (mm)	26
Wear limit of rear brake disc (mm)	20
Front suspension type	Double wishbone independent suspension
Rear suspension type	Multi-link independent suspension



## Wheel alignment parameters

Single-sided front wheel toe-In	$0.15^{\circ} \pm 0.1^{\circ}$
Single-sided front wheel camber angle	$-0.5^{\circ} \pm 0.5^{\circ}$
Kingpin caster angle on one side	$6.8^{\circ} \pm 1^{\circ}$
Kingpin inclination angle on one side	$10.2^{\circ} \pm 1^{\circ}$
Single-sided rear wheel toe-In	$0.1^{\circ} \pm 0.1^{\circ}$
Rear wheel camber	$-1.36^{\circ} \pm 0.5^{\circ}$



## Parameters of electric drive system

Item		Rear electric drive system
Drive motor	Type	Permanent magnet synchronous
	Rated power (kW)	110
	Rated torque (N·m)	170
	Maximum torque (N·m)	440
	Maximum speed (rpm)	18000
Model	Model	1ETP45A
	Gears	1



## Fluid and capacity

### Introduction

Item	Model	Filling amount
Rear electric drive oil (L)	FUCHS 4101	1.35
Coolant (L)	Mixture of ethylene glycol and water	Near MAX line (about 14.5)
A/C refrigerant (g)	R-1234YF	1150±15
Brake fluid (L)	DOT4	Near MAX line (about 1.02)
windshield washer fluid (L)	/	3.0



## Vehicle identification

### Label and nameplate

#### VIN

The vehicle identification number (VIN), as the legal identification mark of the vehicle for the owner registration, should not be scratched, removed, covered, hidden, altered or painted.

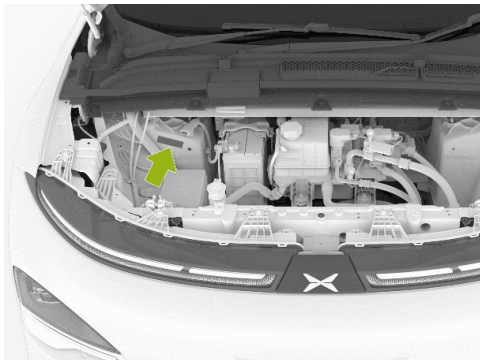

The VIN is engraved on the right side of the cast aluminum shock absorber tower in the front compartment.

The remaining VINs can be found at the following locations:

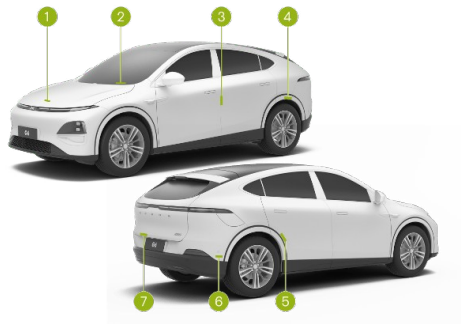

1. Affixed to the inside of the front hood.
2. Affixed to the lower left side of the front windshield.

## Vehicle identification



3. Affixed to the left B-pillar.
4. Affixed to the left rear wheel housing.
5. Right rear door inner panel.
6. Affixed to the front cross member of the rear floor under the rear seat.
7. Left side of the trunk.

## Vehicle product nameplate

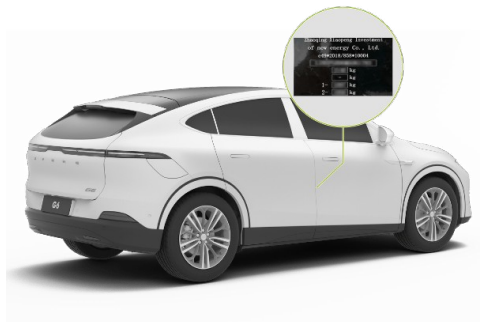

The product nameplate is located below the right B-pillar and can be viewed when the right door is opened.

## Drive motor model and number

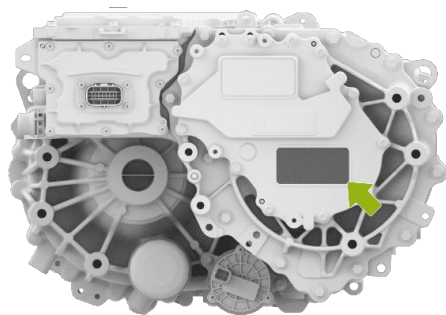

The drive motor model and code are presented on the drive motor housing and the drive motor label.



### User information

#### Vehicle anti-theft alarm system

After the vehicle is locked from the outside, the vehicle anti-theft alarm system will enter the protection status within a period of time. If any one of the doors, front hood and trunk lid is detected to be opened with an invalid key, the vehicle will issue an alarm through lights and horn.

The anti-theft alarm system will be deactivated as the vehicle is unlocked from the outside with a valid key.

#### caution

- This vehicle is equipped the anti-theft alarm system, but it cannot prevent all thefts and guarantee the absolute safety of the vehicle. You need to pay attention to the safety of personal property at all times, so please do not leave valuables in the vehicle.

- Do not modify the anti-theft alarm system at will, as this may cause the system malfunction or the invalid alarm function.

#### Parts and modifications

##### Introduction

When installing the colored or transparent paint film, you should avoid areas such as ultrasonic radar, MMW radar, surround view camera, high sensitivity camera, etc. Otherwise, the normal use of assisted driving and other related functions may be affected.

MMW radar is located in the front and rear bumpers, so it is prohibited to paint the front and rear bumpers, add coverings and perform other operations at will. Otherwise, the normal use of assisted driving and other related functions may be affected.

It is prohibited to replace, modify or add radar or camera at will. Otherwise, the normal use of the assisted driving and other related functions may be affected by the radio interference generated,



resulting in direct or indirect losses, and XPENG will not assume any responsibility. If the radar or camera fails, please go to the XPENG Service Center for repair.

## Event data recorder (EDR)

This vehicle is equipped with an event data recorder (EDR).

The EDR can automatically record the vehicle operation and the status information of vehicle safety systems within a period of time before and after an event, such as:

- Vehicle speed
- Brake pedal depressed or released
- Longitudinal acceleration
- Driver seat belt status
- Accelerator pedal position, percentage of fully open position
- Power-on cycle during the event
- Power-on cycle when reading
- Complete status of event data record

- Time interval between this event and the last event

Collecting and analyzing the vehicle status data recorded by the EDR, can help to understand the relevant situation before and after the event.

The data recorded by the EDR needs to be collected by using a special diagnostic equipment connected to the OBD. If necessary, please contact the XPENG Service Center to get such equipment.

### Data use statement

The EDR data may be used by XPENG for fault diagnosis, product development, and quality improvement. XPENG Service Center will not disclose the data recorded by the EDR to any third parties except in the following cases:

- With the owner's consent
- In compliance with the requirements of administrative and judicial authorities
- In accordance with laws and regulations



### OBD diagnosis interface

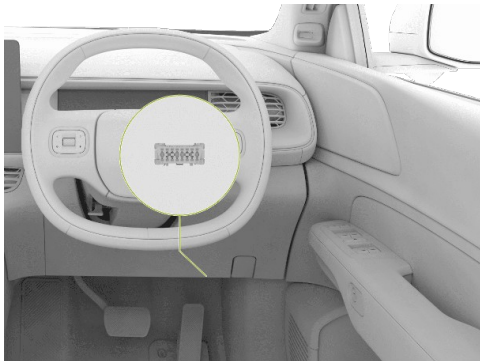

The OBD interface for reading the electronic VIN is located at the lower right of the instrument panel. The electronic VIN, vehicle status information and other data can be read with the original manufacturer's diagnostic apparatus or diagnostic equipment officially approved by the original manufacturer.



X Mobility (Thailand) Co., Ltd.  
156 Ramkhamhaeng Rd, Hua Mak,  
Bang Kapi, Bangkok

**1526**<sup>'''</sup>  
XPENG CALL CENTER

Printing code : G6102025